

RP®

XV-Z3100

OPERATION MANUAL
BEDIENUNGSANLEITUNG
MODE D'EMPLOI
BRUKSANVISNING
MANUAL DE MANEJO
MANUALE DI ISTRUZIONI
GEBRUIKSAANWIJZING

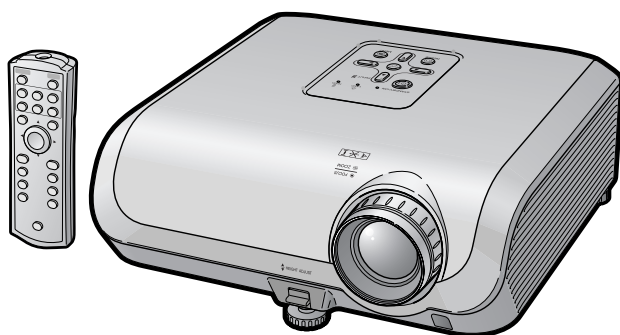

HDMI™
HIGH-DEFINITION MULTIMEDIA INTERFACE

ENGLISH

DEUTSCH

FRANÇAIS



SVENSKA

ESPAÑOL

ITALIANO

NEDERLANDS

SPECIAL NOTE FOR USERS IN THE U.K.

The mains lead of this product is fitted with a non-rewireable (moulded) plug incorporating a 10A fuse. Should the fuse need to be replaced, a BSI or ASTA approved BS 1362 fuse marked  or  and of the same rating as above, which is also indicated on the pin face of the plug, must be used.

Always refit the fuse cover after replacing the fuse. Never use the plug without the fuse cover fitted.

In the unlikely event of the socket outlet in your home not being compatible with the plug supplied, cut off the mains plug and fit an appropriate type.

DANGER:

The fuse from the cut-off plug should be removed and the cut-off plug destroyed immediately and disposed of in a safe manner.

Under no circumstances should the cut-off plug be inserted elsewhere into a 13A socket outlet, as a serious electric shock may occur.

To fit an appropriate plug to the mains lead, follow the instructions below:

WARNING:

THIS APPARATUS MUST BE EARTHED.

IMPORTANT:

The wires in this mains lead are coloured in accordance with the following code:

| | |
|------------------|-----------|
| Green-and-yellow | : Earth |
| Blue | : Neutral |
| Brown | : Live |

As the colours of the wires in the mains lead of this apparatus may not correspond with the coloured markings identifying the terminals in your plug proceed as follows:

- The wire which is coloured green-and-yellow must be connected to the terminal in the plug which is marked by the letter E or by the safety earth symbol  or coloured green or green-and-yellow.
- The wire which is coloured blue must be connected to the terminal which is marked with the letter N or coloured black.
- The wire which is coloured brown must be connected to the terminal which is marked with the letter L or coloured red.

IF YOU HAVE ANY DOUBT, CONSULT A QUALIFIED ELECTRICIAN.

Before using the projector, please read this operation manual carefully.

Introduction

IMPORTANT

- For your assistance in reporting the loss or theft of your Projector, please record the Serial Number located on the bottom of the projector and retain this information.
- Before recycling the packaging, please ensure that you have checked the contents of the carton thoroughly against the list of “Supplied accessories” on page 10.

Model No.: XV-Z3100



Serial No.:

WARNING: High brightness light source. Do not stare into the beam of light, or view directly. Be especially careful that children do not stare directly into the beam of light.



WARNING: To reduce the risk of fire or electric shock, do not expose this product to rain or moisture.

See bottom of projector.

| | | |
|--|--|---|
|  | CAUTION RISK OF ELECTRIC SHOCK. DO NOT REMOVE SCREWS EXCEPT SPECIFIED USER SERVICE SCREW. |  |
| CAUTION: TO REDUCE THE RISK OF ELECTRIC SHOCK, DO NOT REMOVE COVER. NO USER-SERVICEABLE PARTS EXCEPT LAMP UNIT. REFER SERVICING TO QUALIFIED SERVICE PERSONNEL. | | |



The lightning flash with arrowhead symbol, within an equilateral triangle, is intended to alert the user to the presence of uninsulated “dangerous voltage” within the product’s enclosure that may be of sufficient magnitude to constitute a risk or electric shock to persons.



The exclamation point within a triangle is intended to alert the user to the presence of important operating and maintenance (servicing) instructions in the literature accompanying the product.

WARNING:

The cooling fan in this projector continues to run for about 90 seconds after the projector enters standby mode. During normal operation, when putting the projector into standby mode always use the STANDBY/ON button on the projector or the STANDBY button on the remote control. Ensure the cooling fan has stopped before disconnecting the power cord.

DURING NORMAL OPERATION, NEVER TURN THE PROJECTOR OFF BY DISCONNECTING THE POWER CORD. FAILURE TO OBSERVE THIS WILL RESULT IN PREMATURE LAMP FAILURE.

PRODUCT DISPOSAL

This projector utilizes tin-lead solder, and a pressurized lamp containing a small amount of mercury. Disposal of these materials may be regulated due to environmental considerations. For disposal or recycling information, please contact your local authorities or, if you are located in the United States of America, the Electronic Industries Alliance: www.eiae.org .

Caution Concerning Lamp Replacement

See "Replacing the Lamp" on page **56**.

This SHARP projector uses a DLP® chip. This very sophisticated panel contains 921,600 pixels (micromirrors). As with any high technology electronic equipment such as large screen TVs, video systems and video cameras, there are certain acceptable tolerances that the equipment must conform to.

This unit has some inactive pixels within acceptable tolerances which may result in inactive dots on the picture screen. This will not affect the picture quality or the life expectancy of the unit.

How to Read this Operation Manual

- The specifications are slightly different, depending on the model. However, you can connect and operate all models in the same manner.
- In this operation manual, the illustration and the screen display are simplified for explanation, and may differ slightly from the actual display.

Using the Menu Screen

Buttons used in this operation

Menu Selections (Adjustments)

Example: Adjusting "Bright".
 • This operation can also be performed by using the buttons on the projector.

- 1 Press **MENU**.
 - The "Picture" menu screen for the selected input mode is displayed.
- 2 Press **▶** or **◀** to select the menu icon to adjust.
 - The selected icon is highlighted.

Example: "Picture" screen menu for INPUT 1 mode

| Menu icon | Menu screen |
|-----------|-------------|
| | Picture |
| | Fine Sync |
| | Options1 |
| | Options2 |

Note

- The "Fine Sync" menu is not available for INPUT 3 or INPUT 4.

On-screen display

Useful Features

GB -41

InfoIndicates safeguards for using the projector.

NoteIndicates additional information for setting up and operating the projector.

For Future Reference

Maintenance

➔ P. 51

Troubleshooting

➔ PP. 62 and 63

Index

➔ P. 66

Contents

Preparing

Introduction

| | |
|--|----|
| How to Read this Operation Manual | 3 |
| Contents | 4 |
| IMPORTANT SAFEGUARDS | 6 |
| Accessories | 10 |
| Part Names and Functions | 11 |
| Inserting the Batteries | 14 |
| Usable Range | 15 |

Quick Start

| | |
|-------------------|----|
| Quick Start | 16 |
|-------------------|----|

Setup

| | |
|--|----|
| Setting up the Projector | 18 |
| Setting up the Projector | 18 |
| Standard Setup (Front Projection) | 18 |
| Ceiling-mount Setup | 18 |
| Projection (PRJ) Mode | 19 |
| Picture (Screen) Size and Projection Distance | 20 |

Connections

| | |
|--|----|
| Samples of Cables for Connection | 22 |
| Connecting to Video Equipment | 23 |
| Connecting to a Computer | 26 |
| Controlling the Projector by a Computer | 27 |

Using

Basic Operation

| | |
|--|----|
| Turning the Projector On/Off | 28 |
| Connecting the Power Cord | 28 |
| Turning the Projector on | 28 |
| Turning the Power off (Putting the Projector into Standby Mode) | 29 |
| Image Projection | 29 |
| Switching the Input Mode | 29 |
| Adjusting the Projected Image | 30 |
| Correcting Trapezoidal Distortion | 32 |
| Resize Mode | 36 |

Useful Features

| | |
|--|----|
| Operating with the Remote Control | 38 |
| Selecting the Picture Mode | 38 |
| Switching the Iris Setting | 38 |
| Freezing a Moving Image | 38 |
| Menu Items | 39 |
| Using the Menu Screen | 41 |
| Menu Selections (Adjustments) | 41 |
| Picture Adjustment (“Picture” menu) .. | 43 |
| Selecting the Picture Mode | 43 |
| Adjusting the Image | 43 |
| Adjusting the Color Temperature | 44 |
| Adjusting the Colors | 44 |
| Progressive | 44 |
| Reducing Image Noise (DNR) | 45 |
| Switching the Iris Setting | 45 |
| Lamp Setting | 45 |

| | |
|---|----|
| Computer Image Adjustment (“Fine Sync” menu) | 46 |
| Adjusting the Computer Image | 46 |
| Special Modes Setting | 46 |
| Auto Sync (Auto Sync Adjustment) | 46 |
| Checking the Input Signal | 46 |
| Using the “Options” Menu | 47 |
| Adjusting the Overscan | 47 |
| Adjusting the Vertical Size of the Display (Subtitle Setting) | 47 |
| Setting the On-screen Display | 48 |
| Setting the Video System | 48 |
| Signal Type Setting | 48 |
| Selecting the HDMI Setting | 48 |
| Selecting the Background Image | 48 |
| Auto Power Off Function | 49 |
| Checking the Lamp Life Status | 49 |
| Reversing/Inverting Projected Images | 49 |
| Selecting the Transmission Speed (RS-232C) | 50 |
| Reducing the Power Consumption When the Power Is in Standby Mode | 50 |
| Fan Mode Setting | 50 |
| Returning to the Default Settings | 50 |
| Selecting the On-screen Display Language | 50 |

Reference

Appendix

| | | | |
|--|----|--|----|
| Maintenance | 51 | Connecting Pin Assignments | 59 |
| Cleaning and Replacing the Dust Filters | 52 | RS-232C Specifications and Command Settings | 60 |
| Maintenance Indicators | 54 | Computer Compatibility Chart | 61 |
| Regarding the Lamp | 56 | Troubleshooting | 62 |
| Lamp | 56 | Specifications | 64 |
| Caution Concerning the Lamp | 56 | Dimensions | 65 |
| Replacing the Lamp | 56 | Index | 66 |
| Removing and Installing the Lamp Unit | 57 | | |
| Resetting the Lamp Timer | 58 | | |

IMPORTANT SAFEGUARDS

CAUTION: Please read all of these instructions before you operate this product and save these instructions for later use.

Electrical energy can perform many useful functions. This product has been engineered and manufactured to assure your personal safety. BUT IMPROPER USE CAN RESULT IN POTENTIAL ELECTRICAL SHOCK OR FIRE HAZARDS. In order not to defeat the safeguards incorporated in this product, observe the following basic rules for its installation, use and servicing.

1. Read Instructions

All the safety and operating instructions should be read before the product is operated.

2. Retain Instructions

The safety and operating instructions should be retained for future reference.

3. Heed Warnings

All warnings on the product and in the operating instructions should be adhered to.

4. Follow Instructions

All operating and use instructions should be followed.

5. Cleaning

Unplug this product from the wall outlet before cleaning. Do not use liquid cleaners or aerosol cleaners. Use a damp cloth for cleaning.

6. Attachments

Do not use attachments not recommended by the product manufacturer as they may cause hazards.

7. Water and Moisture

Do not use this product near water—for example, near a bath tub, wash bowl, kitchen sink, or laundry tub; in a wet basement; or near a swimming pool; and the like.

8. Accessories

Do not place this product on an unstable cart, stand, tripod, bracket, or table. The product may fall, causing serious injury to a child or adult, and serious damage to the product. Use only with a cart, stand, tripod, bracket, or table recommended by the manufacturer, or sold with the product. Any mounting of the product should follow the manufacturer's instructions, and should use a mounting accessory recommended by the manufacturer.

9. Transportation

A product and cart combination should be moved with care. Quick stops, excessive force, and uneven surfaces may cause the product and cart combination to overturn.



10. Ventilation

Slots and openings in the cabinet are provided for ventilation to ensure reliable operation of the product and to protect it from overheating, and these openings must not be blocked or covered. The openings should never be blocked by placing the product on a bed, sofa, rug, or other similar surface. This product should not be placed in a built-in installation such as a bookcase or rack unless proper ventilation is provided or the manufacturer's instructions have been adhered to.

11. Power Sources

This product should be operated only from the type of power source indicated on the marking label. If you are not sure of the type of power supply to your home, consult your product dealer or local power company. For products intended to operate from battery power, or other sources, refer to the operating instructions.

12. Grounding or Polarization

This product is provided with one of the following types of plugs. If the plug should fail to fit into the power outlet, please contact your electrician.

Do not defeat the safety purpose of the plug.

a. Two-wire type (mains) plug.

b. Three-wire grounding type (mains) plug with a grounding terminal.

This plug will only fit into a grounding type power outlet.

13. Power-Cord Protection

Power-supply cords should be routed so that they are not likely to be walked on or pinched by items placed upon or against them, paying particular attention to cords at plugs, convenience receptacles, and the point where they exit from the product.

14. Lightning

For added protection for this product during a lightning storm, or when it is left unattended and unused for long periods of time, unplug it from the wall outlet and disconnect the cable system. This will prevent damage to the product due to lightning and power-line surges.

15. Overloading

Do not overload wall outlets, extension cords, or integral convenience receptacles as this can result in a risk of fire or electric shock.

16. Object and Liquid Entry

Never push objects of any kind into this product through openings as they may touch dangerous voltage points or short-out parts that could result in a fire or electric shock. Never spill liquid of any kind on the product.

17. Servicing

Do not attempt to service this product yourself as opening or removing covers may expose you to dangerous voltage or other hazards. Refer all servicing to qualified service personnel.

18. Damage Requiring Service

Unplug this product from the wall outlet and refer servicing to qualified service personnel under the following conditions:

- a. When the power-supply cord or plug is damaged.
- b. If liquid has been spilled, or objects have fallen into the product.
- c. If the product has been exposed to rain or water.
- d. If the product does not operate normally by following the operating instructions. Adjust only those controls that are covered by the operating instructions, as an improper adjustment of other controls may result in damage and will often require extensive work by a qualified technician to restore the product to normal operation.
- e. If the product has been dropped or damaged in any way.
- f. When the product exhibits a distinct change in performance, this indicates a need for service.

19. Replacement Parts

When replacement parts are required, be sure the service technician has used replacement parts specified by the manufacturer or have the same characteristics as the original part. Unauthorized substitutions may result in fire, electric shock, or other hazards.

20. Safety Check

Upon completion of any service or repairs to this product, ask the service technician to perform safety checks to determine that the product is in proper operating condition.

21. Wall or Ceiling Mounting

This product should be mounted to a wall or ceiling only as recommended by the manufacturer.

22. Heat

This product should be situated away from heat sources such as radiators, heat registers, stoves, or other products (including amplifiers) that produce heat.

- The DLP® logo, the DLP® medallion and BrilliantColor™ are trademarks of Texas Instruments.
- Microsoft® and Windows® are registered trademarks of Microsoft Corporation in the United States and/or other countries.
- PC/AT is a registered trademark of International Business Machines Corporation in the United States.
- Macintosh® is a registered trademark of Apple Computer, Inc. in the United States and/or other countries.
- HDMI, the HDMI logo and High-Definition Multimedia Interface are trademarks or registered trademarks of HDMI Licensing LLC.
- All other company or product names are trademarks or registered trademarks of their respective companies.
- Some IC chips in this product include confidential and/or trade secret property belonging to Texas Instruments. Therefore you may not copy, modify, adapt, translate, distribute, reverse engineer, reverse assemble or discompile the contents thereof.

Observe the following safeguards when setting up your projector.

Caution concerning the lamp unit

- Potential hazard of glass particles if lamp ruptures. In case of lamp rupture, contact your nearest Sharp Authorized Projector Dealer or Service Center for replacement. See “Replacing the Lamp” on page 56.

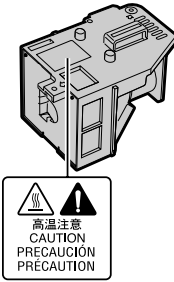

Caution concerning the setup of the projector

- For minimal servicing and to maintain high image quality, SHARP recommends that this projector be installed in an area free from humidity, dust and cigarette smoke. When the projector is subjected to these environments, the vents and lens must be cleaned more often. As long as the projector is regularly cleaned, use in these environments will not reduce the overall operation life of the unit. Internal cleaning should only be performed by a Sharp Authorized Projector Dealer or Service Center.

Do not set up the projector in places exposed to direct sunlight or bright light.

- Position the screen so that it is not in direct sunlight or room light. Light falling directly on the screen washes out the colors, making viewing difficult. Close the curtains and dim the lights when setting up the screen in a sunny or bright room.

Caution regarding placing of the projector

- Place the projector on a level site within the adjustment range (8 degrees) of the adjustment foot.

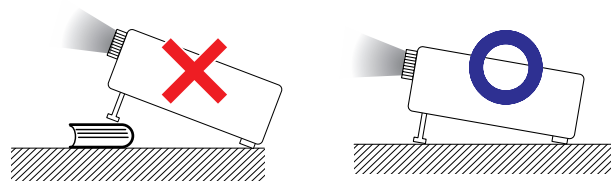

- After the projector is purchased, a faint smell from the vent may appear when the power is first turned on. This is normal and is not a malfunction. It will disappear after the projector is used for a while.

When using the projector in high-altitude areas such as mountains (at altitudes of approximately 4,900 feet (1,500 meters) or more)

- When you use the projector in high-altitude areas with thin air, set “Fan Mode” to “High”. Neglecting this can affect the longevity of the optical system.

Warning about placing the projector in a high position

- When placing the projector in a high position, make certain it is carefully secure to avoid personal injury caused by the projector falling down.

Do not subject the projector to hard impact and/or vibration.

- Protect the lens so as not to hit or damage the surface of the lens.

Rest your eyes occasionally.

- Continuously watching the screen for long hours will cause eye strain. Take regular breaks to rest your eyes.

Avoid locations with extremes of temperature.

- The operating temperature of the projector is from 41°F to 95°F (+5°C to +35°C).
- The storage temperature of the projector is from -4°F to 140°F (-20°C to +60°C).

Do not block the exhaust and intake vents.

- Allow at least 11 ¹³/₁₆ inches (30 cm) of space between the exhaust vent and the nearest wall or obstruction.
- Be sure that the intake vent and the exhaust vent are not obstructed.
- If the cooling fan becomes obstructed, a protection circuit will automatically put the projector into standby mode to prevent overheat damage. This does not indicate a malfunction. (See pages 54 and 55.) Remove the projector power cord from the wall outlet and wait at least 10 minutes. Place the projector where the intake and exhaust vents are not blocked, plug the power cord back in and turn on the projector. This will return the projector to the normal operating condition.

- When turning off the projector, the cooling fan runs to decrease the internal temperature for a while. Unplug the power cord after the cooling fan stops. The period the cooling fan runs will vary, depending on the circumstances and the internal temperature.

Caution regarding usage of the projector

- When using the projector, take care not to subject it to hard impact and/or vibration, as this can result in damage. Take extra care with the lens. Before moving the projector, make certain you unplug the power cord from the wall outlet, and disconnect any other cables connected to it.
- Do not carry the projector by holding the lens.
- When storing the projector, ensure you attach the lens cap. (See page 11).
- Do not expose the projector to direct sunlight or place next to heat sources. Doing so may affect the cabinet color or cause deformation of the plastic cover.

Other connected equipment

- When connecting a computer or other audio-visual equipment to the projector, make the connections AFTER unplugging the power cord of the projector from the AC outlet and turning off the equipment to be connected.
- Please read the operation manuals of the projector and the equipment to be connected for instructions on how to make the connections.

Using the projector in other countries

- The power supply voltage and the shape of the plug may vary depending on the region or country you are using the projector in. When using the projector overseas, make sure you use an appropriate power cord for the country you are in.

Temperature monitor function



- If the projector starts to overheat due to setup problems or blockage of the air vents, “” and “TEMP.” will illuminate in the lower left corner of the picture. If the temperature continues to rise, the lamp will turn off, the temperature warning indicator on the projector will blink, and after a 90-second cooling-off period the projector will enter standby mode. Refer to “Maintenance Indicators” on page 54 for details.

Info

- The cooling fan regulates the internal temperature, and its performance is automatically controlled. The sound of the fan may change during projector operation due to changes in the fan speed. This does not indicate malfunction.
- Do not unplug the power cord during projection or cooling fan operation. This can cause damage due to rise in internal temperature, as the cooling fan also stops.

Accessories

Supplied accessories

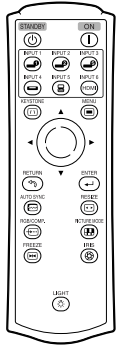

Remote control
RRMCGA543WJSB



Two R-03 batteries
("AAA" size, UM/SUM-4,
HP-16 or similar)

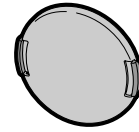

Lens cap (attached)
CCAPHA024WJSA

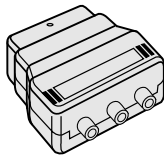

21 pin RCA
conversion adaptor
QSOCZ0361CEZZ

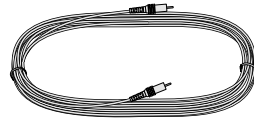

Video cable
QCNWGA001WJZZ

- Operation manual

Power cord*
(1)

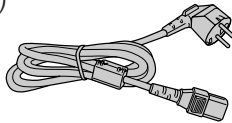

For Europe,
except U.K.
(6' (1.8 m))
QACCVA011WJPZ

(2)

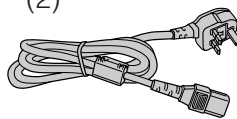

For U.K. and
Singapore
(6' (1.8 m))
QACCB A036WJPZ

(3)

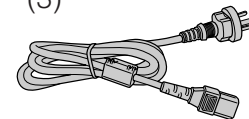

For Australia, New
Zealand and Oceania
(6' (1.8 m))
QACCLA018WJPZ

* Use the power cord that corresponds to the wall outlet in your country.

Optional accessories

| | |
|---|-----------|
| ■ Lamp unit | AN-XR10L2 |
| ■ DIN-D-sub RS-232C adaptor (5 ⁵⁷ / ₆₄ " (15 cm)) | AN-A1RS |
| ■ 3 RCA to 15-pin D-sub cable (10' (3.0 m)) | AN-C3CP2 |

Note

- Some of the optional accessories may not be available depending on the region. Please check with your nearest Sharp Authorized Projector Dealer or Service Center.

Part Names and Functions

Numbers in **■** refer to the main pages in this operation manual where the topic is explained.

Projector

Top View

Power indicator

28, 54

Lamp indicator

28, 54

STANDBY/ON button

For turning the power on and putting the projector into standby mode.

28

STANDBY/ON

LAMP

TEMP.

Temperature warning indicator

54

INPUT buttons (▲/▼)
For switching input mode 1, 2, 3, 4, 5 or 6.

29

ENTER button
For setting items selected or adjusted on the menu.

41

ENTER

MENU button
For displaying adjustment and setting screens.

41

RESIZE button
For switching the screen size.

36

RESIZE

MENU

Adjustment buttons (▲/▼/◀/▶)
For selecting menu items.

41

Front View

Focus ring
For adjusting the focus.

30

Intake vent

51

Zoom ring
For enlarging/reducing the picture.

30

HEIGHT ADJUST lever

30

Remote control sensor (front)

15

Push both sides of the lens cap to attach or remove.

Part Names and Functions (Continued)

Numbers in refer to the main pages in this operation manual where the topic is explained.

Rear View

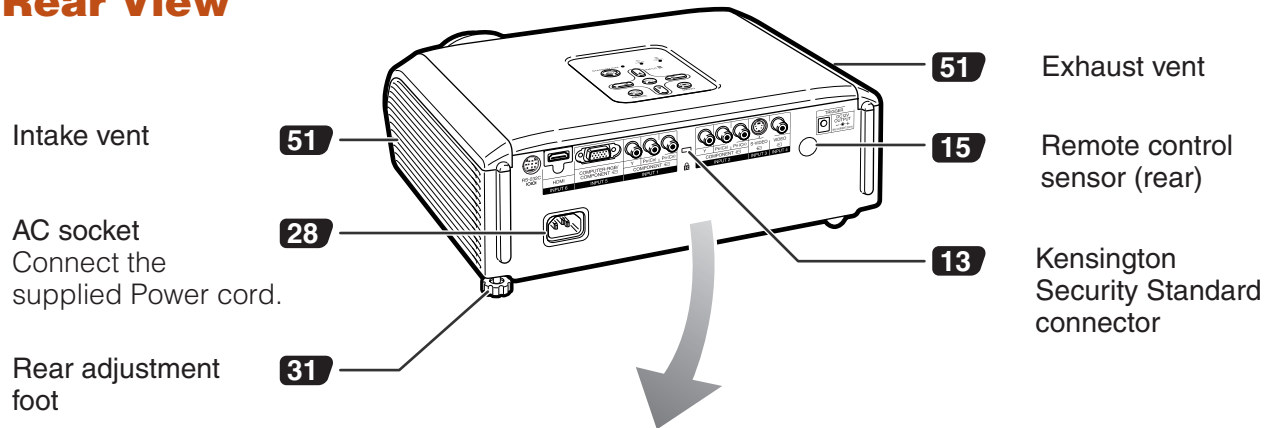

Terminals

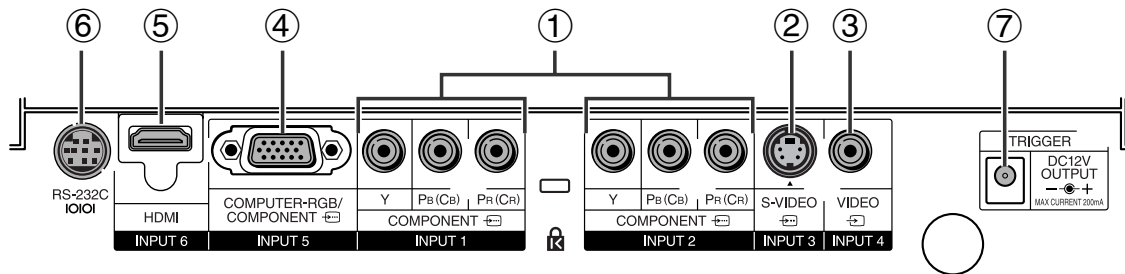

| Terminal | Description | Page |
|----------|--|--|
| ① | INPUT 1, 2 terminal Connecting video equipment with component output terminal (DVD player, DTV decoder, DVD recorder with hard disc, etc.). | 23 |
| ② | INPUT 3 terminal Connecting video equipment with S-video output terminal (VCR, DVD player, etc.). | 24 |
| ③ | INPUT 4 terminal Connecting video equipment without S-video output terminal. | 24 |
| ④ | INPUT 5 terminal | 25 |
| | <ul style="list-style-type: none"> ■ Connecting video equipment with component output terminal (DVD player, DTV decoder, DVD recorder with hard disc, etc.). ■ Connecting the computer. | 26 |
| ⑤ | INPUT 6 terminal Connecting video equipment with HDMI output terminal. | 25 |
| ⑥ | RS-232C terminal Connecting the computer to control the projector. | 27 |
| ⑦ | TRIGGER terminal When the projector is turned on, a control signal (DC 12V) outputs from this terminal. If an electric screen or other compatible device is connected, it can be turned on when the projector is turned on. | — |

Numbers in **■** refer to the main pages in this operation manual where the topic is explained.

STANDBY button
For putting the projector into the standby mode.

KEYSTONE button
For entering the Keystone Correction mode.

RETURN button
For returning to the previous menu screen during menu operations.

AUTO SYNC button
For automatically adjusting images when connected to a computer.

RGB/COMP. button
For switching to the respective input signal type.

FREEZE button
For freezing images.

Backlight button
For lighting all buttons on the remote control.

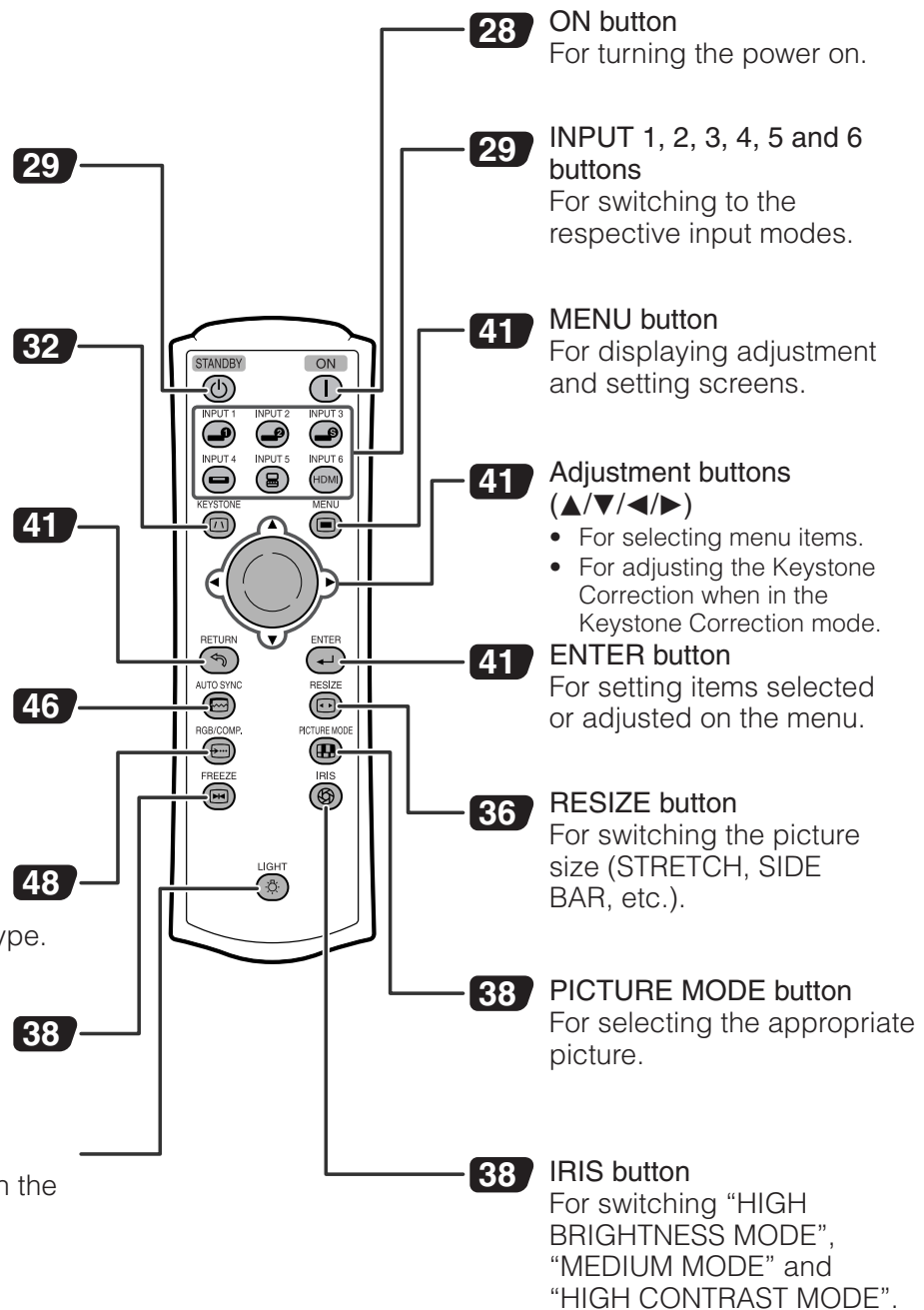

Using the Kensington Lock on the projector

- This projector has a Kensington Security Standard connector for use with a Kensington MicroSaver Security System. Refer to the information that came with the system for instructions on how to use it to secure the projector.

Part Names and Functions (Continued)

Inserting the Batteries

- 1 Press the ▲ mark on the cover and slide it in the direction of the arrow.**

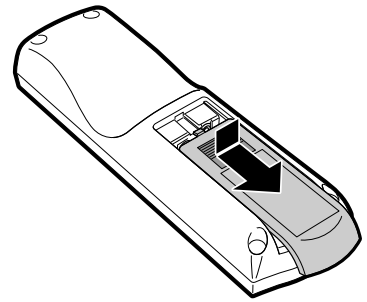

- 2 Insert the batteries.**
 - Insert the batteries making sure the polarities correctly match the ⊕ and ⊖ marks inside the battery compartment.

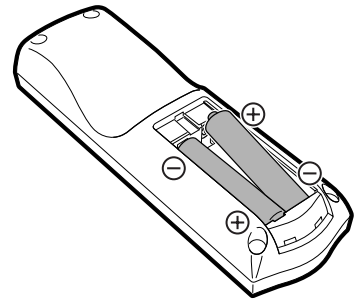

- 3 Attach the cover and slide it until it clicks into place.**

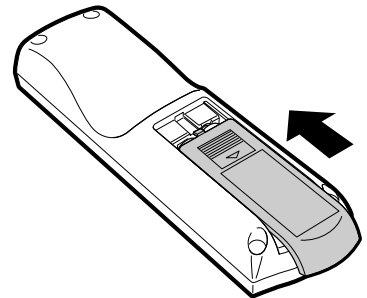

Incorrect use of the batteries may cause them to leak or explode. Please follow the precautions below.



Caution

- Danger of explosion if battery is incorrectly replaced. Replace only with the same or equivalent type.
 - Insert the batteries making sure the polarities correctly match the ⊕ and ⊖ marks inside the battery compartment.
 - Batteries of different types have different properties, therefore do not mix batteries of different types.
 - Do not mix new and old batteries. This may shorten the life of new batteries or may cause old batteries to leak.
 - Remove the batteries from the remote control once they have run out, as leaving them in can cause them to leak. Battery fluid from leaked batteries is harmful to skin, therefore ensure you wipe them first and then remove them using a cloth.
-
- The batteries included with this projector may run down in a short period, depending on how they are kept. Be sure to replace them as soon as possible with new batteries.
 - Remove the batteries from the remote control if you will not be using the remote control for a long time.
 - Comply with the rules (ordinance) of each local government when disposing of worn-out batteries.

Usable Range

The remote control can be used to control the projector within the ranges shown in the illustration.

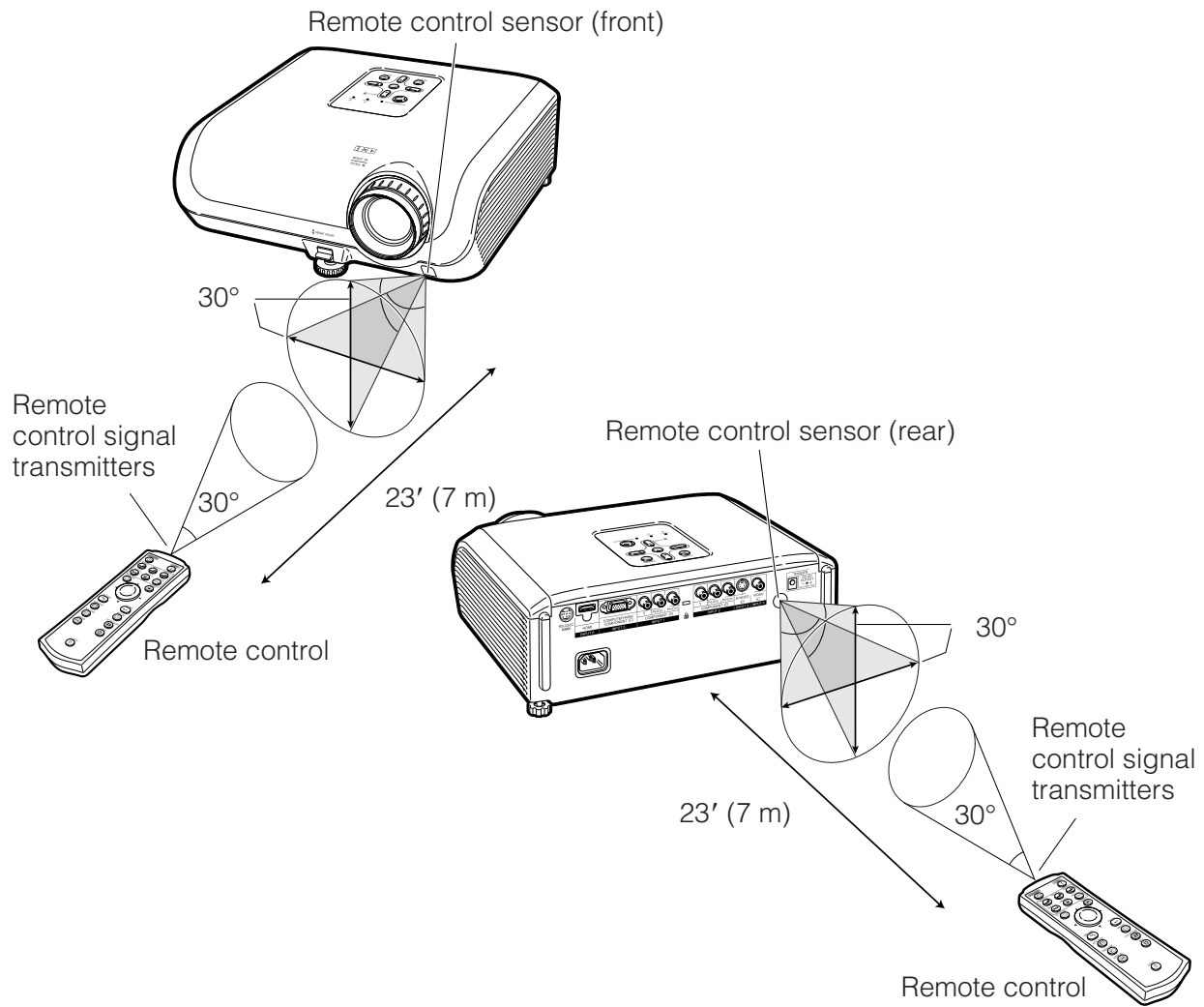

Note

- The signal from the remote control can be reflected off a screen for easy operation. However, the effective distance of the signal may differ depending on the screen material.

When using the remote control

- Ensure that you do not drop it or expose it to moisture or high temperature.
- The remote control may malfunction under a fluorescent lamp. In this case, move the projector away from the fluorescent lamp.

Quick Start

This section shows the basic operation (projector connecting with the video equipment). For details, see the page described below for each step.

Setup and Projection

In this section, connection of the projector and the video equipment is explained using one example.

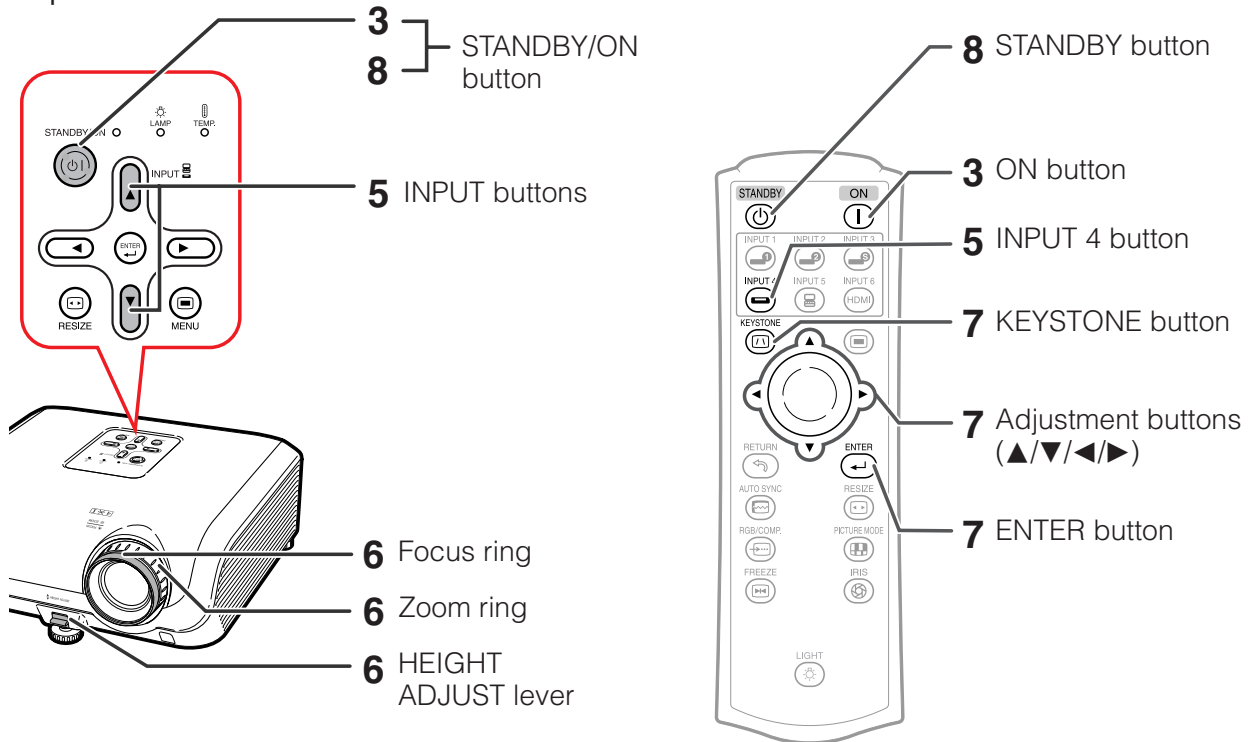

1. Place the projector facing a wall or a screen → P. 18

2. Connect the projector to the video equipment and plug the power cord into the AC socket of the projector → PP. 22–28

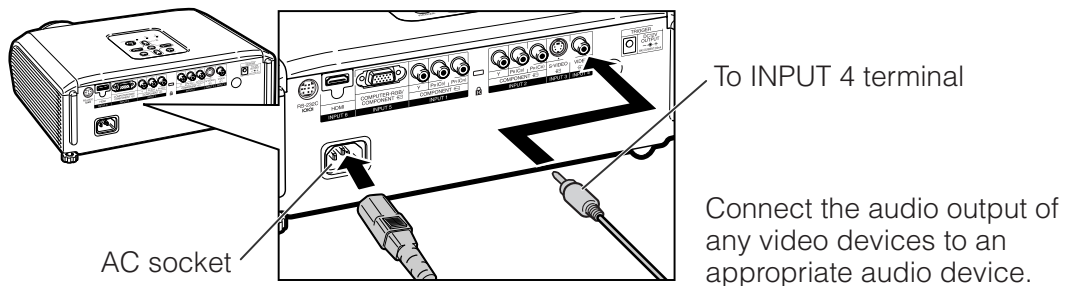

3. Remove the lens cap and turn the projector on → P. 28

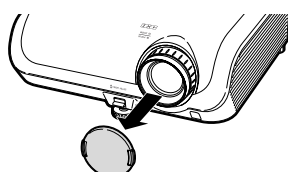

On the projector



On the remote control



4. Turn the video equipment on and start playback

5. Select the INPUT mode

→ P. 29

Select the "INPUT 4" using the INPUT buttons on the projector or the INPUT 4 button on the remote control.

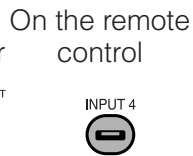
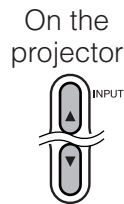

On-screen display



- When pressing the INPUT buttons on the projector, input mode switches in the following order: **INPUT1↔INPUT2↔INPUT3↔INPUT4↔INPUT5↔INPUT6↔**
- Pressing the INPUT buttons on the remote control also allows you to switch the input mode.

6. Adjust the focus, image size, and projector angle

→ PP. 30, 31

1. Adjust the focus by turning the focus ring.

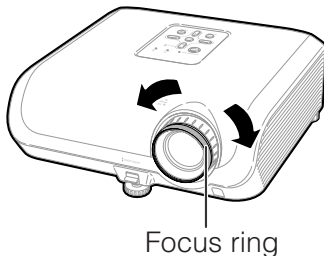

2. Adjust the projection image size by turning the zoom ring.

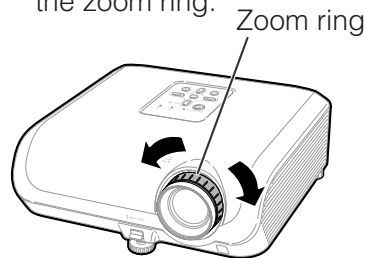

3. Adjust the projector angle using the HEIGHT ADJUST lever.

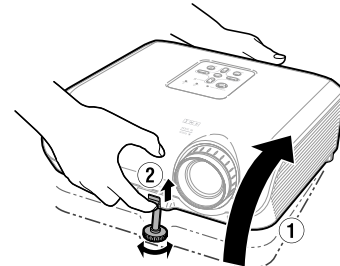

7. Correct trapezoidal distortion (GEOMETRIC ADJUSTMENT)

→ PP. 32–35

1. Press **Ⓚ** KEYSTONE on the remote control.
2. Press **▲/▼/◀/▶** on the remote control to set the upper-left position of the projected image.
3. Press **⊕** ENTER on the remote control to set the position.
4. Follow steps 2 and 3 to also set the upper-right, lower-right, and lower-left positions of the projected image.
 - When you confirm the lower left position, the screen adjustments will be set and setup will end.

8. Turn the Power off

→ P. 29

Press the STANDBY/ON button on the projector or the STANDBY button on the remote control, and then press the button again while the confirmation message is displayed to put the projector into standby mode.

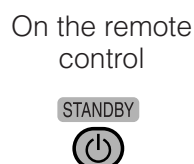

On-screen Display

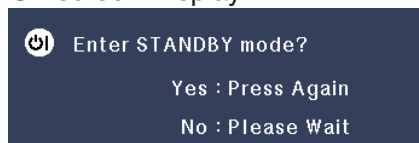

- Unplug the power cord from the AC outlet after the cooling fan stops.

Setting up the Projector

Setting up the Projector

For optimal image quality, position the projector perpendicular to the screen with the projector's feet flat and level. Doing so will eliminate the need for Keystone correction and provide the best image quality.

Standard Setup (Front Projection)

- Place the projector at the required distance from the screen according to the desired picture size. (See page 20.)

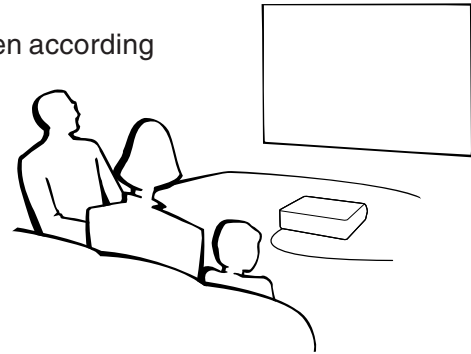

Example of standard setup

Side View

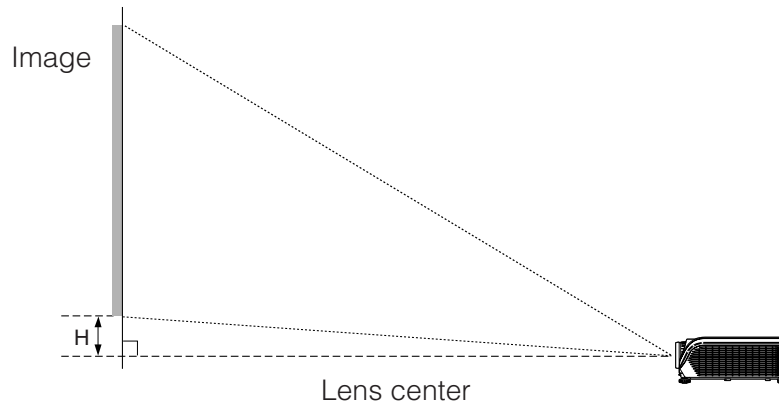

Note

- Refer to page 20 for additional information concerning "Picture (Screen) Size and Projection Distance".

Ceiling-mount Setup

- It is recommended that you use the optional Sharp ceiling-mount bracket for this installation. Before mounting the projector, contact your nearest Sharp Authorized Projector Dealer or Service Center to obtain the recommended ceiling-mount bracket (sold separately).
 - AN-60KT ceiling-mount bracket, its AN-TK201 and AN-TK202 extension tubes.
- Invert the image by setting "Ceiling + Front" in "PRJ Mode". See page 49 for use of this function.

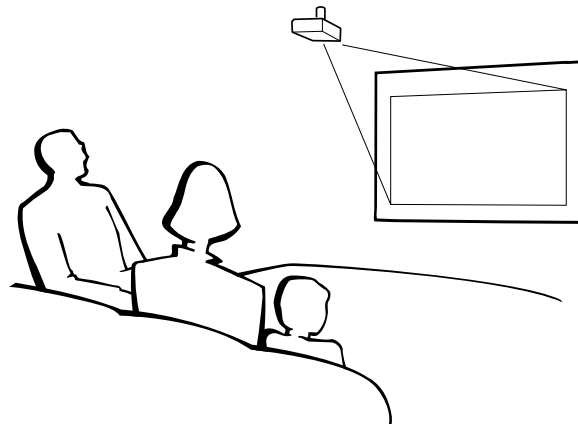

Projection (PRJ) Mode

The projector can use any of the 4 projection modes shown in the diagram below. Select the mode most appropriate for the projection setting in use. (You can set the PRJ Mode in "Options2" menu. See page 49.)

■ Table mounted, front projection

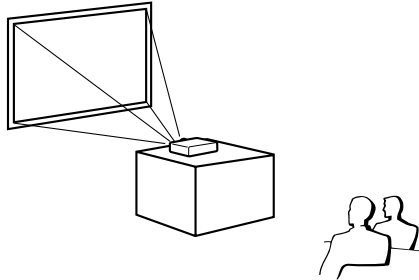

■ Ceiling mounted, front projection

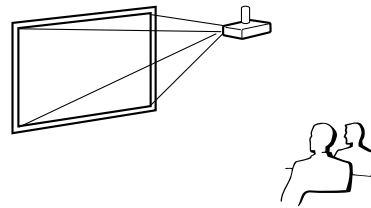

Menu item → "Front"

Menu item → "Ceiling + Front"

■ Table mounted, rear projection (with a translucent screen)

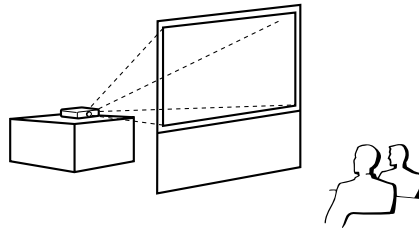

■ Ceiling mounted, rear projection (with a translucent screen)

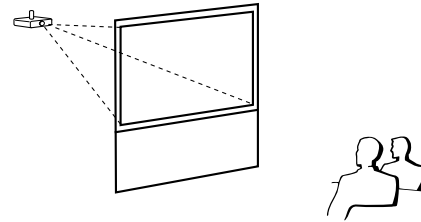

Menu item → "Rear"

Menu item → "Ceiling + Rear"

Indication of the Projection Image Size and Projection Distance

Refer to page 20 for additional information concerning "Picture (Screen) Size and Projection Distance".

Example: When using a wide screen (16:9)

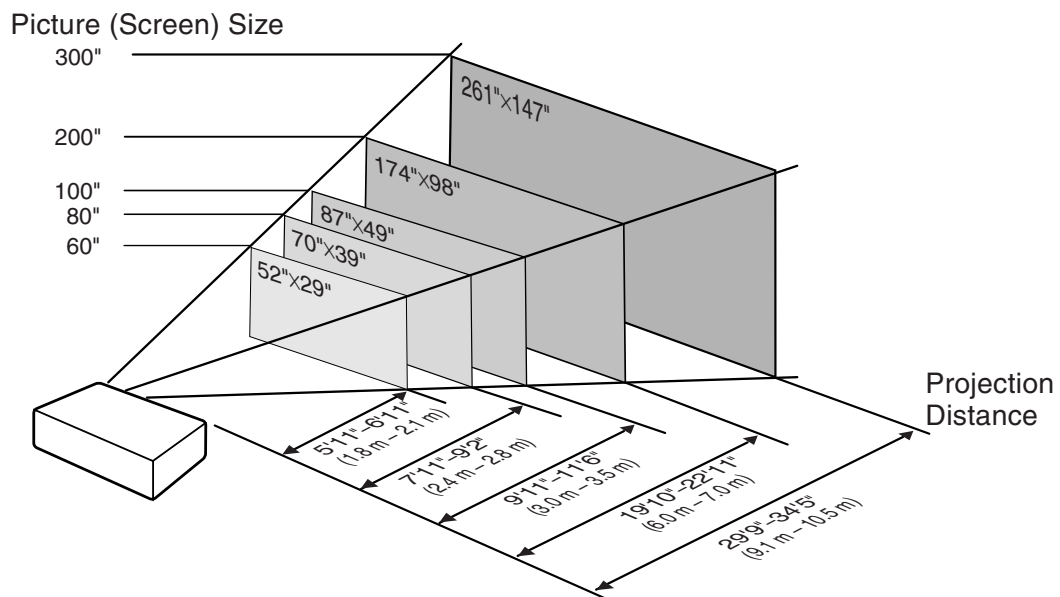

Setting up the Projector (Continued)

Picture (Screen) Size and Projection Distance

The projection screen size varies according to the distance from the lens of the projector to the screen. Install the projector so that projected images are projected onto the screen at the optimum size by referring to the table below. Use the values in the table as a reference when installing the projector.

When using a wide screen (16:9) and projecting 16:9 image

| Picture (Screen) size | | | Projection distance [L] | | Distance from the lens center to the bottom of the image [H] |
|-----------------------|---------------|---------------|-------------------------|-----------------|--|
| Diag. [χ] | Width | Height | Minimum [L1] | Maximum [L2] | |
| 300" (762 cm) | 261" (664 cm) | 147" (374 cm) | 29' 9" (9.1 m) | 34' 5" (10.5 m) | 21 1/32" (53 cm) |
| 270" (686 cm) | 235" (598 cm) | 132" (336 cm) | 26' 9" (8.2 m) | 30' 11" (9.4 m) | 18 15/16" (48 cm) |
| 250" (635 cm) | 218" (553 cm) | 123" (311 cm) | 24' 9" (7.5 m) | 28' 8" (8.7 m) | 17 17/32" (45 cm) |
| 200" (508 cm) | 174" (443 cm) | 98" (249 cm) | 19' 10" (6.0 m) | 22' 11" (7.0 m) | 14 1/64" (36 cm) |
| 150" (381 cm) | 131" (332 cm) | 74" (187 cm) | 14' 10" (4.5 m) | 17' 2" (5.2 m) | 10 33/64" (27 cm) |
| 100" (254 cm) | 87" (221 cm) | 49" (125 cm) | 9' 11" (3.0 m) | 11' 6" (3.5 m) | 7 1/64" (18 cm) |
| 80" (203 cm) | 70" (177 cm) | 39" (100 cm) | 7' 11" (2.4 m) | 9' 2" (2.8 m) | 5 39/64" (14 cm) |
| 70" (178 cm) | 61" (155 cm) | 34" (87 cm) | 6' 11" (2.1 m) | 8' 0" (2.4 m) | 4 29/32" (12 cm) |
| 60" (152 cm) | 52" (133 cm) | 29" (75 cm) | 5' 11" (1.8 m) | 6' 11" (2.1 m) | 4 13/64" (11 cm) |
| 40" (102 cm) | 35" (89 cm) | 20" (50 cm) | 4' 0" (1.2 m) | 4' 7" (1.4 m) | 2 51/64" (7 cm) |

χ: Picture (Screen) size (diag.) (in/cm)

L: Projection distance (ft/m)

L1: Minimum projection distance (ft/m)

L2: Maximum projection distance (ft/m)

H: Distance from the lens center to the bottom of the image (in/cm)

The formula for picture size and projection distance

[Feet/inches]

L1 (ft) = 0.03019χ / 0.3048

L2 (ft) = 0.03493χ / 0.3048

H (in) = 0.17808χ / 2.54

[m/cm]

L1 (m) = 0.03019χ

L2 (m) = 0.03493χ

H (cm) = 0.17808χ

When using a normal screen (4:3) and projecting 4:3 image (SIDE BAR Mode)

| Picture (Screen) size | | | Projection distance [L] | | Distance from the lens center to the bottom of the image [H] |
|-----------------------|---------------|---------------|-------------------------|------------------|--|
| Diag. [χ] | Width | Height | Minimum [L1] | Maximum [L2] | |
| 300" (762 cm) | 240" (610 cm) | 180" (457 cm) | 36' 4" (11.1 m) | 42' 1" (12.8 m) | 25 47/64" (65 cm) |
| 270" (686 cm) | 216" (549 cm) | 162" (411 cm) | 32' 9" (10.0 m) | 37' 10" (11.5 m) | 23 11/64" (59 cm) |
| 250" (635 cm) | 200" (508 cm) | 150" (381 cm) | 30' 4" (9.2 m) | 35' 1" (10.7 m) | 21 29/64" (54 cm) |
| 200" (508 cm) | 160" (406 cm) | 120" (305 cm) | 24' 3" (7.4 m) | 28' 1" (8.6 m) | 17 5/32" (44 cm) |
| 150" (381 cm) | 120" (305 cm) | 90" (229 cm) | 18' 2" (5.5 m) | 21' 0" (6.4 m) | 12 7/8" (33 cm) |
| 100" (254 cm) | 80" (203 cm) | 60" (152 cm) | 12' 1" (3.7 m) | 14' 0" (4.3 m) | 8 37/64" (22 cm) |
| 80" (203 cm) | 64" (163 cm) | 48" (122 cm) | 9' 8" (3.0 m) | 11' 3" (3.4 m) | 6 55/64" (17 cm) |
| 70" (178 cm) | 56" (142 cm) | 42" (107 cm) | 8' 6" (2.6 m) | 9' 10" (3.0 m) | 6" (15 cm) |
| 60" (152 cm) | 48" (122 cm) | 36" (91 cm) | 7' 3" (2.2 m) | 8' 5" (2.6 m) | 5 9/64" (13 cm) |
| 40" (102 cm) | 32" (81 cm) | 24" (61 cm) | 4' 10" (1.5 m) | 5' 7" (1.7 m) | 3 7/16" (9 cm) |

χ: Picture (Screen) size (diag.) (in/cm)

L: Projection distance (ft/m)

L1: Minimum projection distance (ft/m)

L2: Maximum projection distance (ft/m)

H: Distance from the lens center to the bottom of the image (in/cm)

The formula for picture size and projection distance

[Feet/inches]

L1 (ft) = 0.03694χ / 0.3048

L2 (ft) = 0.04275χ / 0.3048

H (in) = 0.21794χ / 2.54

[m/cm]

L1 (m) = 0.03694χ

L2 (m) = 0.04275χ

H (cm) = 0.21794χ

When using a normal screen (4:3) and projecting 16:9 image

| Picture (Screen) size | | | Projection distance [L] | | Distance from the lens center to the bottom of the image [H] |
|-----------------------|---------------|---------------|-------------------------|----------------|--|
| Diag. [χ] | Width | Height | Minimum [L1] | Maximum [L2] | |
| 300" (762 cm) | 240" (610 cm) | 180" (457 cm) | 27' 3" (8.3 m) | 31' 7" (9.6 m) | 19 ⁵ / ₁₆ " (49 cm) |
| 270" (686 cm) | 216" (549 cm) | 162" (411 cm) | 24' 7" (7.5 m) | 28' 5" (8.7 m) | 17 ³ / ₈ " (44 cm) |
| 250" (635 cm) | 200" (508 cm) | 150" (381 cm) | 22' 9" (6.9 m) | 26' 4" (8.0 m) | 16 ³ / ₃₂ " (41 cm) |
| 200" (508 cm) | 160" (406 cm) | 120" (305 cm) | 18' 2" (5.5 m) | 21' 0" (6.4 m) | 12 ⁷ / ₈ " (33 cm) |
| 150" (381 cm) | 120" (305 cm) | 90" (229 cm) | 13' 8" (4.2 m) | 15' 9" (4.8 m) | 9 ²¹ / ₃₂ " (25 cm) |
| 100" (254 cm) | 80" (203 cm) | 60" (152 cm) | 9' 1" (2.8 m) | 10' 6" (3.2 m) | 6 ⁷ / ₁₆ " (16 cm) |
| 80" (203 cm) | 64" (163 cm) | 48" (122 cm) | 7' 3" (2.2 m) | 8' 5" (2.6 m) | 5 ⁹ / ₆₄ " (13 cm) |
| 70" (178 cm) | 56" (142 cm) | 42" (107 cm) | 6' 4" (1.9 m) | 7' 4" (2.2 m) | 4 ¹ / ₂ " (11 cm) |
| 60" (152 cm) | 48" (122 cm) | 36" (91 cm) | 5' 5" (1.7 m) | 6' 4" (1.9 m) | 3 ⁵⁵ / ₆₄ " (10 cm) |
| 40" (102 cm) | 32" (81 cm) | 24" (61 cm) | 3' 8" (1.1 m) | 4' 2" (1.3 m) | 2 ³⁷ / ₆₄ " (7 cm) |

χ : Picture (Screen) size (diag.) (in/cm)

L: Projection distance (ft/m)

L1: Minimum projection distance (ft/m)

L2: Maximum projection distance (ft/m)

H: Distance from the lens center to the bottom of the image (in/cm)

The formula for picture size and projection distance

[Feet/inches]

L1 (ft) = 0.02771 χ / 0.3048

L2 (ft) = 0.03206 χ / 0.3048

H (in) = 0.16346 χ / 2.54

[m/cm]

L1 (m) = 0.02771 χ

L2 (m) = 0.03206 χ

H (cm) = 0.16346 χ











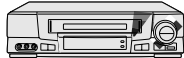

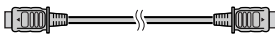

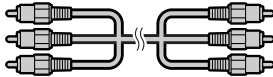
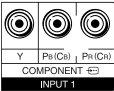
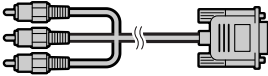
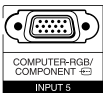
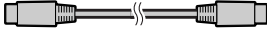
Note

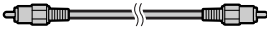
- Allow a margin of error in the values in the diagrams.

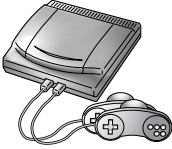
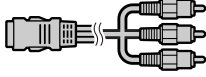
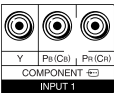
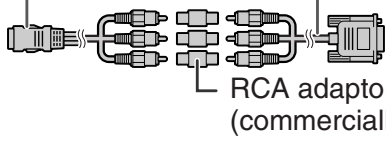
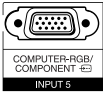
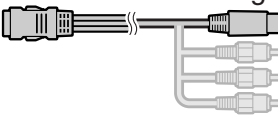
Samples of Cables for Connection

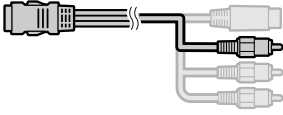
- For more details of connection and cables, refer to the operation manual of the connecting equipment.
- You may need other cables or connectors not listed below.

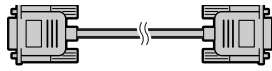
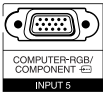
| Equipment | Input Signal | Cable | Terminal on the projector |
|--|-----------------|--|--|
| Audio-visual equipment    | HDMI video | HDMI cable (commercially available)  | INPUT6  |
| | Component video | Component cable (commercially available)  | INPUT1, 2  |
| | Component video | 3 RCA to 15-pin D-sub cable (optional accessory: AN-C3CP2)  | INPUT5  |
| | S-video | S-video cable (commercially available)  | INPUT3  |
| | Video | Video cable (supplied)  | INPUT4  |
| Camera/video game   | Component video | Cables for a camera or a video game  | INPUT1, 2  |
| | Component video | Cables for a camera or a video game 3 RCA to 15-pin D-sub cable (optional accessory: AN-C3CP2) RCA adaptor plug (commercially available)  | INPUT5  |
| | S-video | Cables for a camera or a video game  | INPUT3  |
| | Video | Cables for a camera or a video game  | INPUT4  |
| Computer  | RGB video | RGB cable (commercially available)  | INPUT5  |

Connecting to Video Equipment

Before connecting, ensure that the power cord of the projector is unplugged from the AC outlet and turn off the devices to be connected. After making all connections, turn on the projector first and then the other devices.

When connecting the component video equipment to the component input terminal on the projector (INPUT1 or INPUT2)

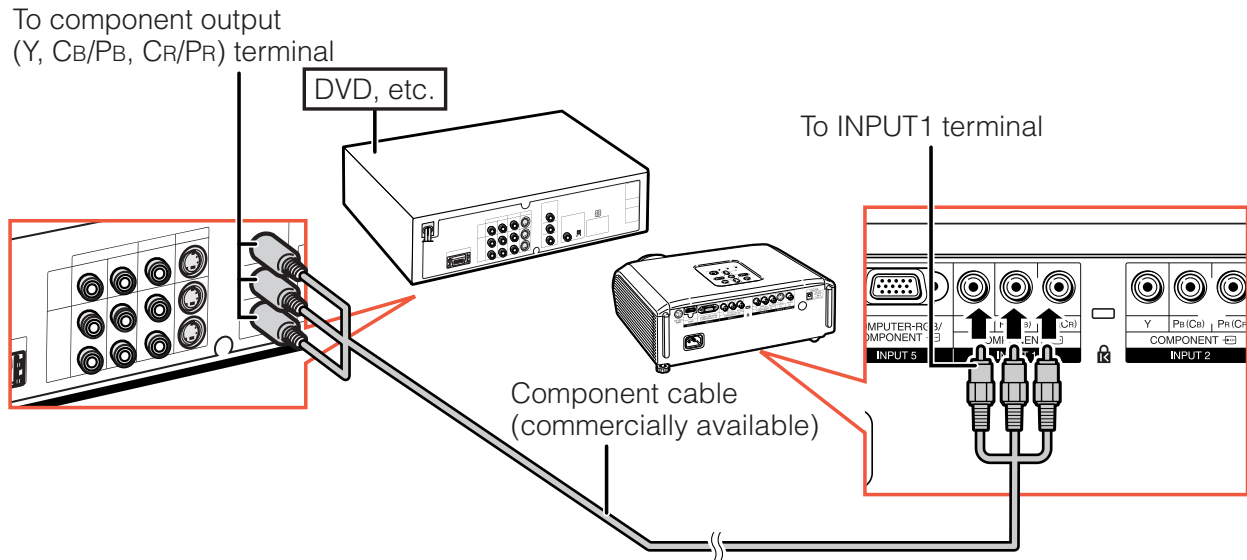

Connecting to Video Equipment (Continued)

When connecting to equipment with S-video output terminal (INPUT3)

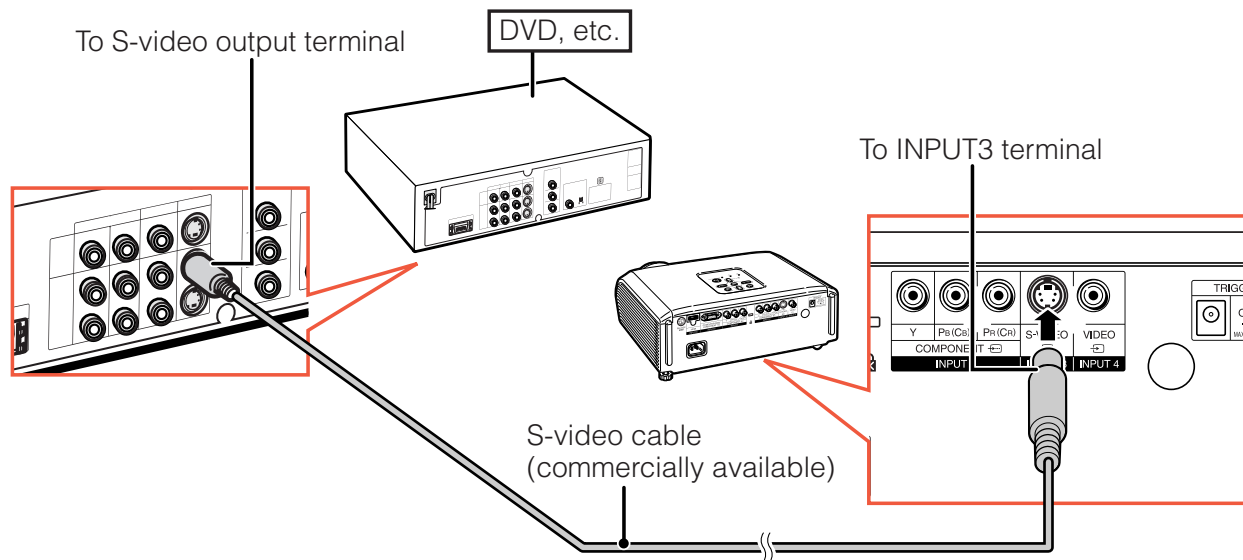

When connecting to equipment with video output terminal (INPUT4)

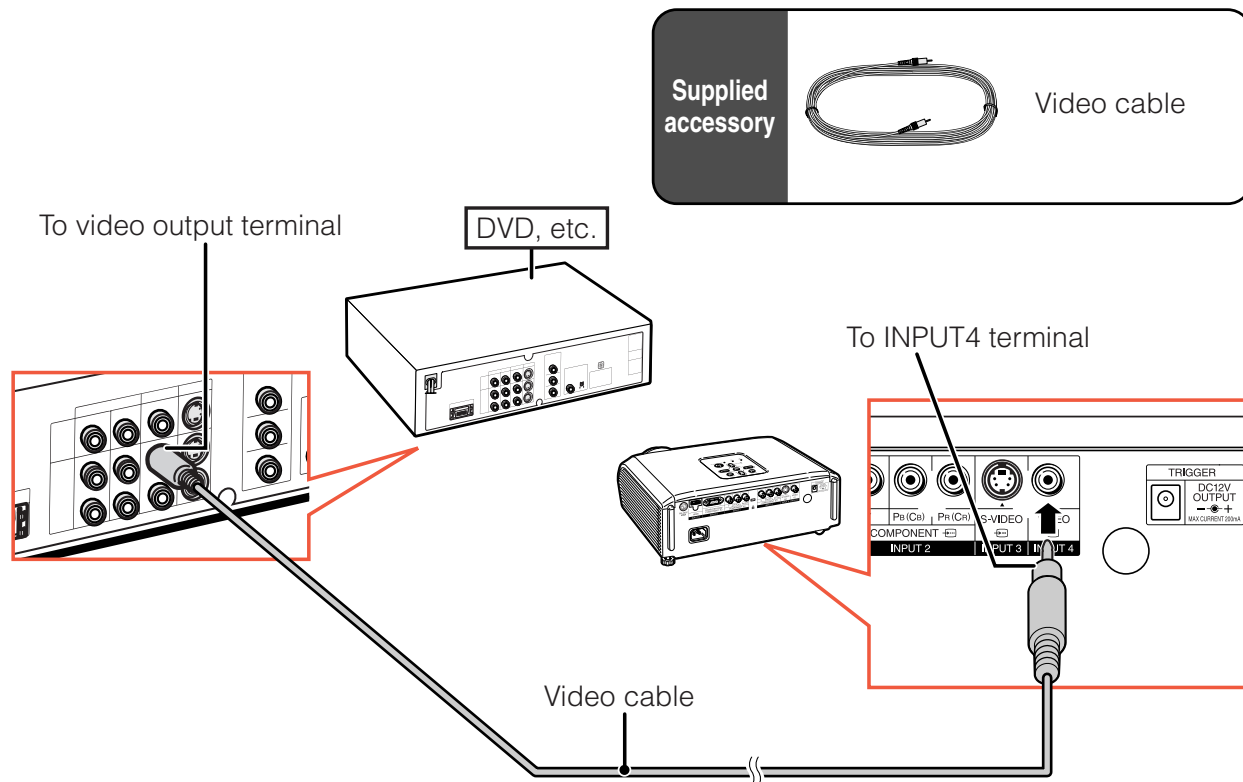

When connecting the component video equipment to the computer-RGB/component input terminal on the projector (INPUT5)

To component output
(Y, C_B/P_B, C_R/P_R) terminal

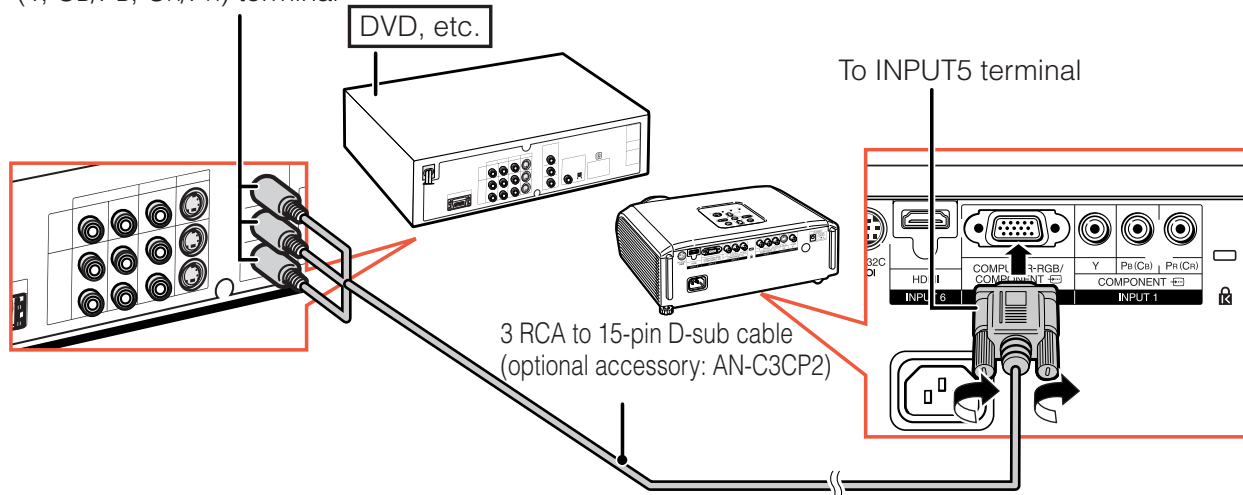

When connecting to equipment with HDMI output terminal (INPUT6)

HDMI is a new specialized interface capable of delivering a video and audio signal to the terminal using just one cable. Since this projector does not support an audio signal by itself, use an amplifier or other audio device.

For video connection, use a cable that conforms to HDMI standards. Using cables that do not conform to HDMI standards may result in a malfunction.

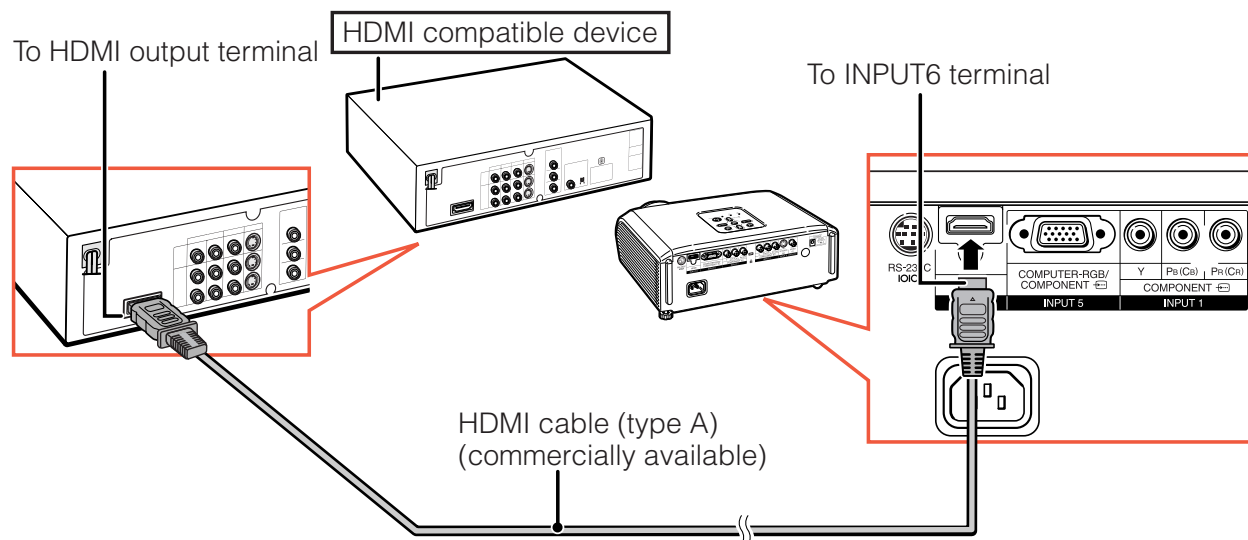

Note

- HDMI (High Definition Multimedia Interface) is a digital AV interface that can deliver a high-definition video signal, multi-channel audio signal, and bi-directional control signal all in just one cable.
- Because it is compatible with the HDCP (High-bandwidth Digital Content Protection) system, the digital video signal does not degrade when transmitted, and a high-quality image with a simple connection can be enjoyed.
- When a DVI to HDMI conversion cable is connected to the HDMI terminal, a proper picture may not be displayable.

Connecting to a Computer

When connecting a computer, ensure that it is the last device to be turned on after all the connections are made.

Ensure that you have read the operation manuals of the devices to be connected before making connections.

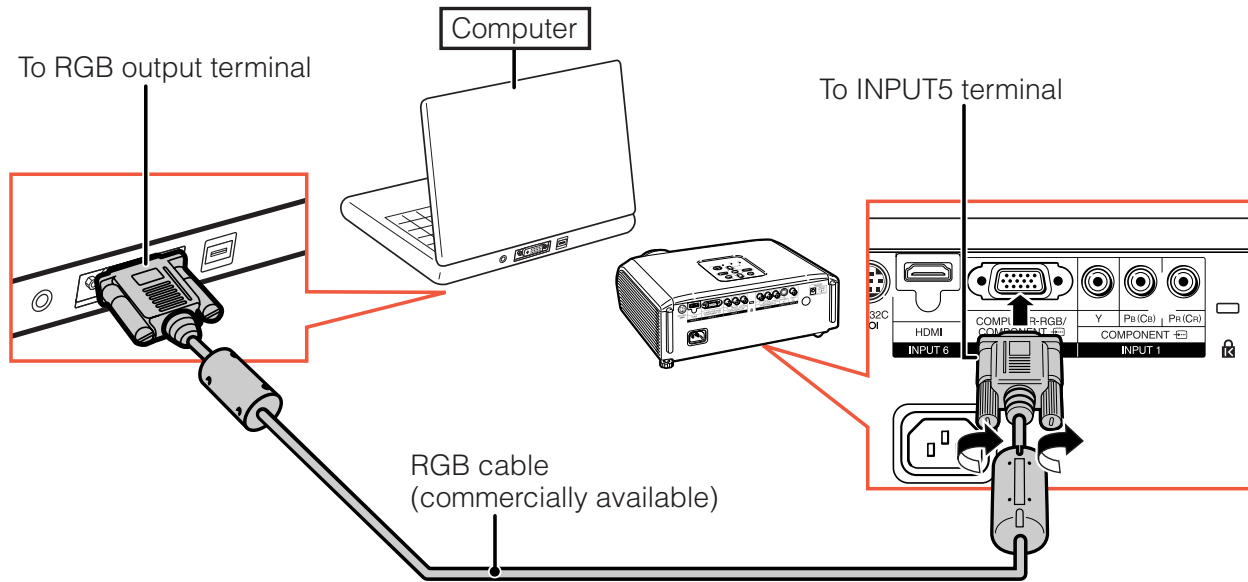

Note

- See page 61 "Computer Compatibility Chart" for a list of computer signals compatible with the projector. Use with computer signals other than those listed may cause some of the functions to not work.
- A Macintosh adaptor may be required for use with some Macintosh computers. Contact your nearest Macintosh Dealer.
- **Depending on the computer you are using, an image may not be projected unless the computer's external output port is switched on. (e.g. Press "Fn" and "F5" keys simultaneously when using a SHARP notebook computer).** Refer to the specific instructions in your computer's operation manual to enable your computer's external output port.

Controlling the Projector by a Computer

When the RS-232C terminal on the projector is connected to a computer with a DIN-D-sub RS-232C adaptor (optional accessory: AN-A1RS) and an RS-232C serial control cable (cross type, commercially available), the computer can be used to control the projector and check the status of the projector. See page 60 for detail.

When connecting to a computer using an RS-232C serial control cable and a DIN-D-sub RS-232C adaptor

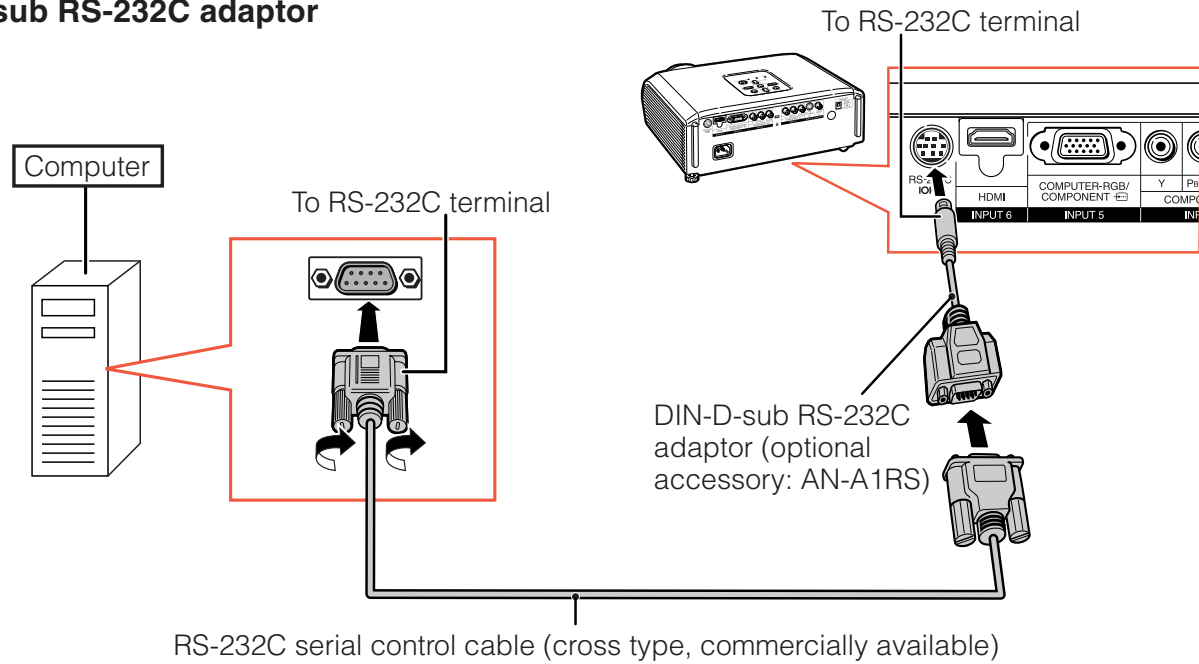

Note

- The RS-232C function may not operate if your computer terminal is not correctly set up. Refer to the operation manual of the computer for details.
- See page 60 for connection of an RS-232C serial control cable.

Info

- Do not connect the RS-232C cable to a port other than the RS-232C terminal on the computer. This may damage your computer or projector.
- Do not connect or disconnect an RS-232C serial control cable to or from the computer while it is on. This may damage your computer.

Turning the Projector On/Off

Connecting the Power Cord

Plug the supplied power cord into the AC socket on the rear of the projector. Then plug into AC outlet.

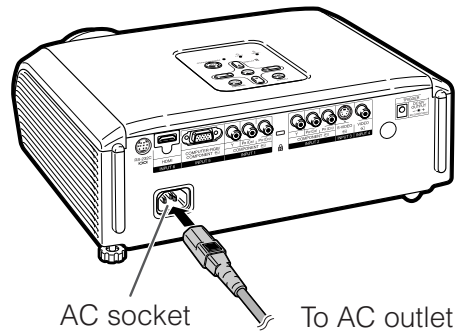
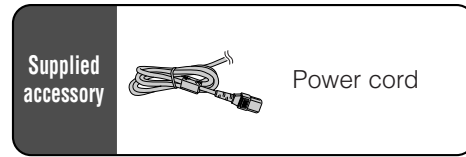

Turning the Projector on

Note that the connections to external equipment and power outlet should be done before performing the operations written below. (See pages 23 to 28.)

Remove the lens cap and press **STANDBY/ON** on the projector or **ON** on the remote control.

Info

- English is the factory default language. If you want to change the on-screen display to another language, change the language according to the procedure on page 50.

Note

About the Lamp Indicator

The lamp indicator illuminates to indicate the status of the lamp.

Green: The lamp is on.

Blinking in green: The lamp is warming up or shutting down.

Red: The lamp is shut down abnormally or the lamp should be replaced.

- When switching on the projector, a slight flickering of the image may be experienced within the first minute after the lamp has been illuminated. This is normal operation as the lamp's control circuitry is stabilising the lamp output characteristics. It should not be regarded as faulty operation.
- If the projector is put into standby mode and immediately turned on again, the lamp may take some time to start projection.

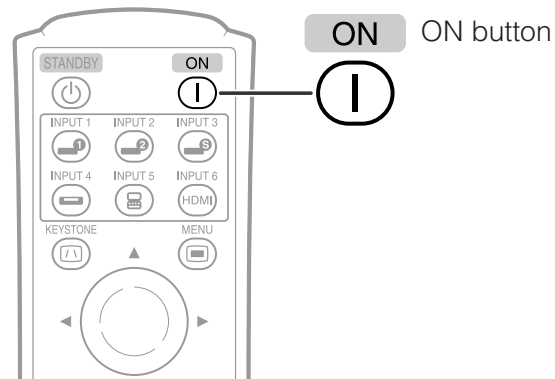
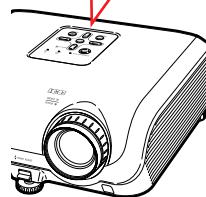
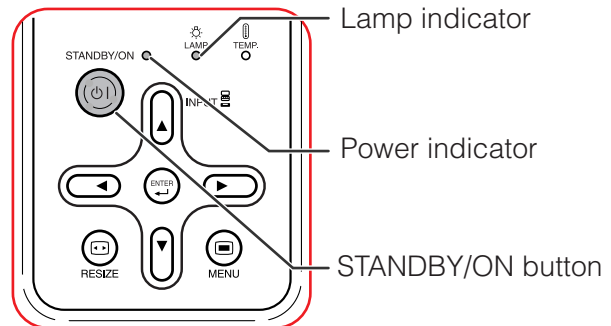

Turning the Power off (Putting the Projector into Standby Mode)

- 1** Press **⏻** STANDBY/ON on the projector or **⏻** STANDBY on the remote control, then press that button again while the confirmation message is displayed, to put the projector into standby mode.
- 2** Unplug the power cord from the AC outlet after the cooling fan stops.
 - The power indicator on the projector blinks in green while cooling.
 - The power indicator changes to red when the projector finishes cooling.

Info

- Do not unplug the power cord during projection or cooling fan operation. This can cause damage due to rise in internal temperature, as the cooling fan also stops.

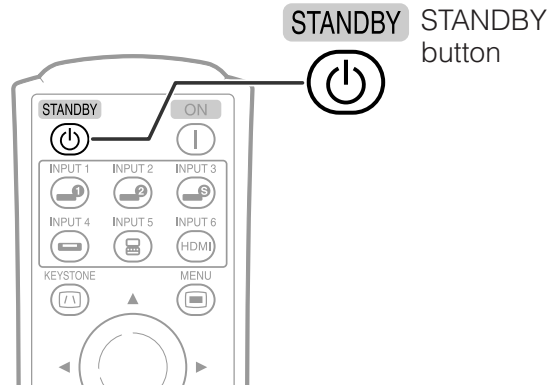

On-screen Display (confirmation message)

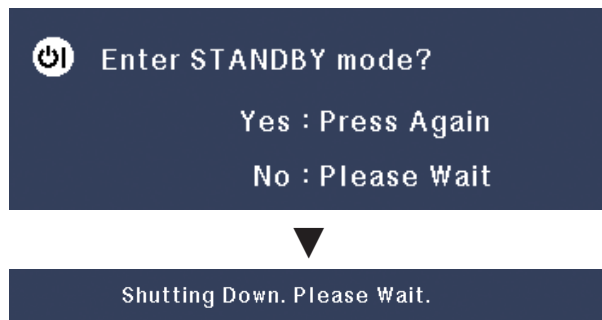

Image Projection

Switching the Input Mode

Select the appropriate input mode for the connected equipment.

Press the appropriate INPUT button on the remote control to select the desired input mode.

- When pressing INPUT (**▲/▼**) on the projector, input mode switches in the following order:

```

INPUT1 ↔ INPUT2 ↔ INPUT3
  ↑       ↓
INPUT6 ↔ INPUT5 ↔ INPUT4
    
```

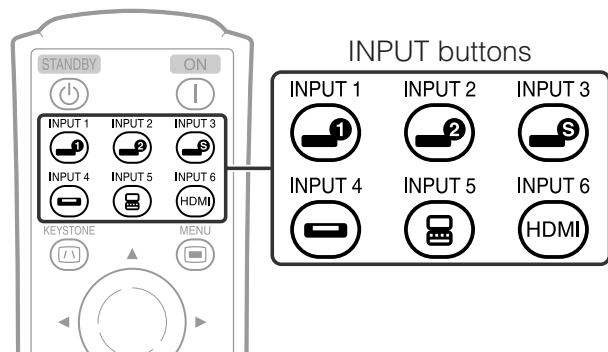

Image Projection (Continued)

Adjusting the Projected Image

1 Adjusting the Focus

You can adjust the focus with the focus ring on the projector.

Rotate the focus ring to adjust the focus while watching the projected image.

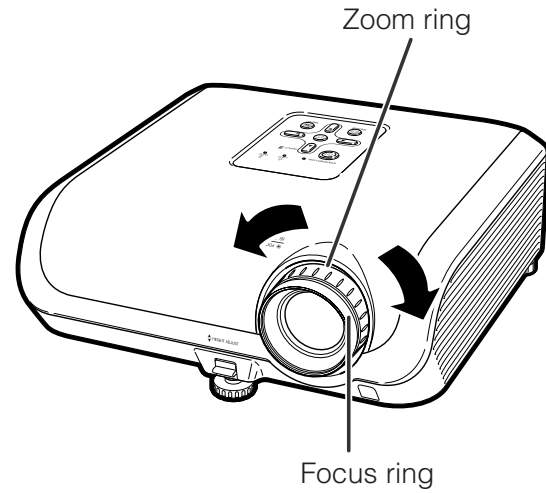

2 Adjusting the Picture Size

You can adjust the picture size using the zoom ring on the projector.

Rotate the zoom ring to enlarge or shrink the picture size.

3 Adjusting the Height

The height of the projector can be adjusted using the adjustment feet at the front and rear of the projector.

When the screen is above the projector, the projection image can be made higher by adjusting the projector.

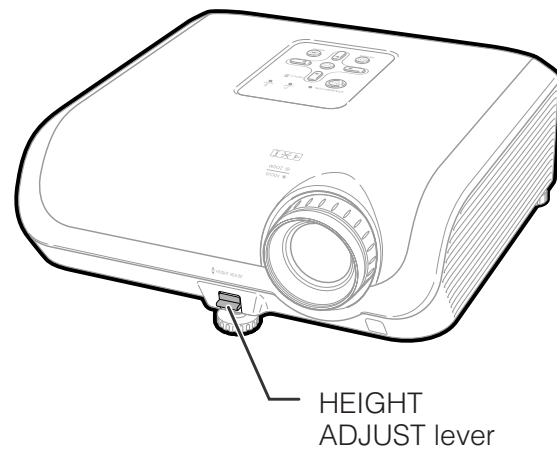

1 Lift the projector to adjust its height while lifting the HEIGHT ADJUST lever.

2 Remove your hands from the HEIGHT ADJUST lever of the projector after its height has been finely adjusted.

- The angle of projection is adjustable up to 8 degrees from the surface on which the projector is placed.

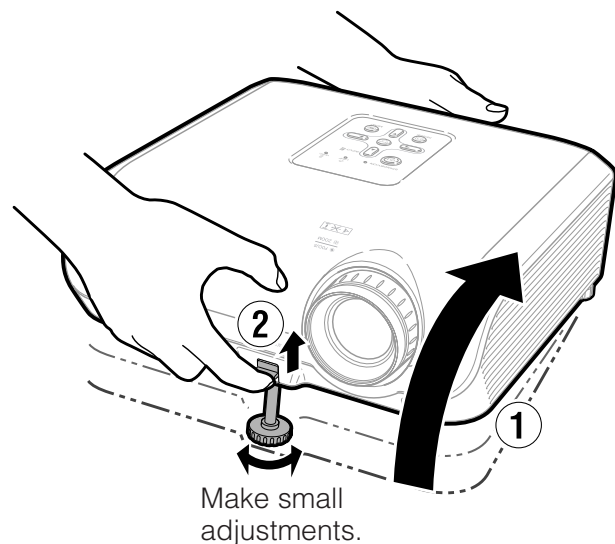

3 Use the rear adjustment foot to make the projector level.

- The projector is adjustable ± 1 degree from the standard position.

Note

- When adjusting the height of the projector, trapezoidal distortion occurs. Follow the procedures in Keystone Correction to correct the distortion. (See page 32.)

Info

- Do not apply too much pressure on the projector when the front adjustment foot comes out.
- When lowering the projector, be careful not to get your fingers caught in the area between the adjustment foot and the projector.
- Hold the projector firmly while lifting or carrying.
- Do not hold by the lens area.

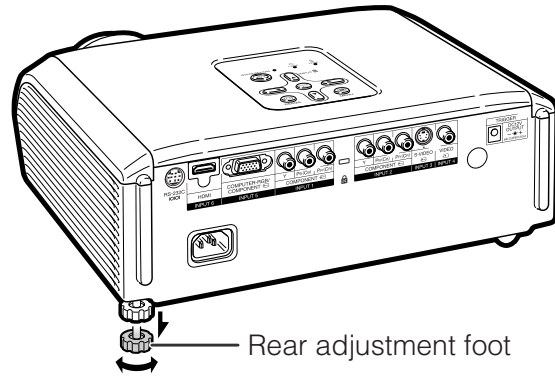

Image Projection (Continued)

Correcting Trapezoidal Distortion

When the image is projected either from the top or from the bottom towards the screen at an angle, the image becomes distorted trapezoidally. The function for correcting trapezoidal distortion is called Keystone Correction.

There are the two types of the Keystone Correction.

- 1) The “GEOMETRIC ADJUSTMENT” method corrects trapezoidal distortion by specifying 4 marks on the screen.
- 2) The “H & V KEYSTONE” method features corrections to 2 axes (horizontal and vertical) based on numerical values.

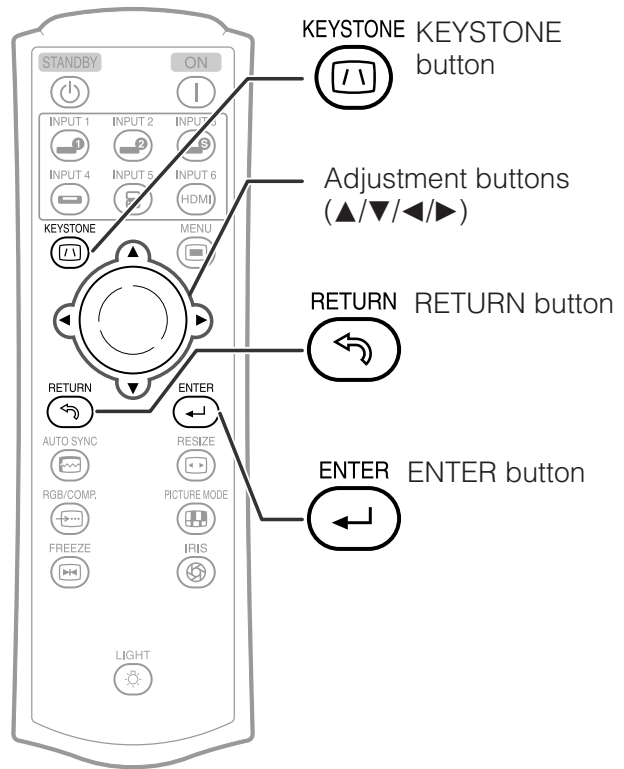

Selecting the Type of Correction

Select the Keystone correction method.

Press  KEYSTONE on the remote control.

- “GEOMETRIC ADJUSTMENT” will be displayed.
- Each time  KEYSTONE is pressed, the display toggles as follows:

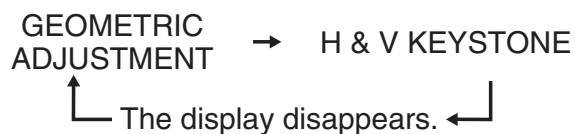

| | |
|----------------------|--|
| GEOMETRIC ADJUSTMENT | For correcting an image by designating the corner of the projected image. (See page 34.) |
| H & V KEYSTONE | For correcting an image by designating the horizontal or vertical axes. (See page 35.) |

Note

- When corrections are made with Keystone correction, the changes are saved even if the power cord is unplugged.
- Since Keystone correction digitally corrects the signal, resolution may slightly decrease when it is used. Moiré patterns and line distortions may also be visible in detailed images. However, this is not a malfunction.
- If you cannot correct trapezoidal distortion with Keystone correction, change the placement position of the projector.
- Straight lines and the edges of the displayed image may appear jagged, when adjusting the Keystone setting.
- Also read “About Copyrights” on page **37.**

Image Projection (Continued)

GEOMETRIC ADJUSTMENT

Info

- When adjusting a 4:3-aspect-ratio input signal to a 4:3-aspect-ratio screen, correct the trapezoidal distortion by setting "RESIZE" to "STRETCH" (16:9).

1 Press **KEYSTONE** on the remote control repeatedly until "GEOMETRIC ADJUSTMENT" is displayed.

2 Adjust the focus, size, and projection angle so that the screen edges line up into the blue area.

- Line up the screen edges into the blue area as closely as possible.

3 Press **▲**, **▼**, **◀** or **▶** to move the position for the upper left of the image.

- Adjust the screen until the displayed red arrows line up in the upper left.

4 Press **ENTER** to set the position.

- The arrow in the upper right turns red.

5 Repeat the same procedure with the positions for the upper right, lower right and lower left of the image.

- When you press **RETURN** at this point, you will return to the previous screen.
- If you press **RETURN** before adjusting the upper left corner, the Reset Confirmation screen displays.
- **When you confirm the lower left position, the screen adjustments will be set and the "GEOMETRIC ADJUSTMENT" mode will end.**

Note

- The placement of the screen and the projector may result in the image aspect ratio becoming slightly distorted.
- Try "H&V KEYSTONE" when "GEOMETRIC ADJUSTMENT" does not fully correct trapezoidal distortion.

On-screen display

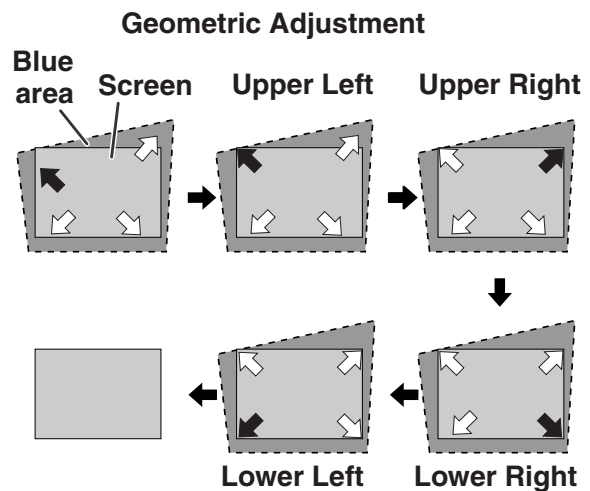
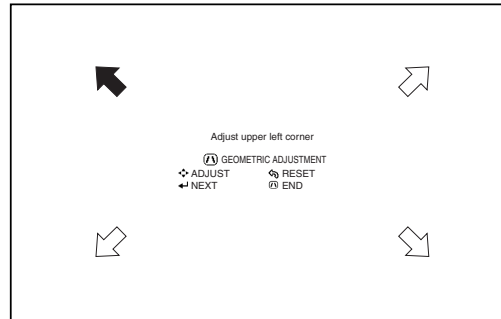

H & V KEYSTONE

1 Project the image and adjust the focus, image size, and projection angle.

2 Press **Ⓜ** **KEYSTONE** on the remote control repeatedly until “H & V KEYSTONE” is displayed.

- When the “GEOMETRIC ADJUSTMENT” mode has been used to adjust the image, a confirmation screen displays before the “H & V KEYSTONE” screen, asking if you want to reset the adjustments or not. Then select RESET.

3 Press **▲** or **▼** on the remote control to align the left and right sides of the projected image.

4 Press **◀** or **▶** on the remote control to align the upper and lower sides of the projected image.

5 Press **Ⓜ** **KEYSTONE** or **↵** **ENTER** on the remote control and the “H&V KEYSTONE” mode ends.

Note

- If adjustments are made using both “H KEYSTONE” and “V KEYSTONE” at the same time, the image aspect ratio may become slightly distorted.
- When adjusting “H KEYSTONE” and “V KEYSTONE” at the same time, the values of adjustable angles for each setting become smaller.
- The adjustable value of the “V KEYSTONE” becomes extremely small when “H KEYSTONE” is made to be the maximum value.

▼ On-screen display

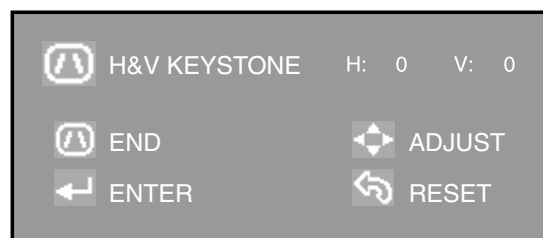

Vertical Keystone Correction (Adjustment with ▲ / ▼)

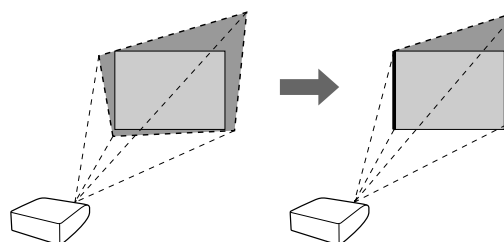

Horizontal Keystone Correction (Adjustment with ◀ / ▶)

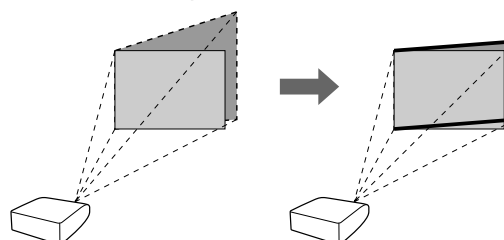
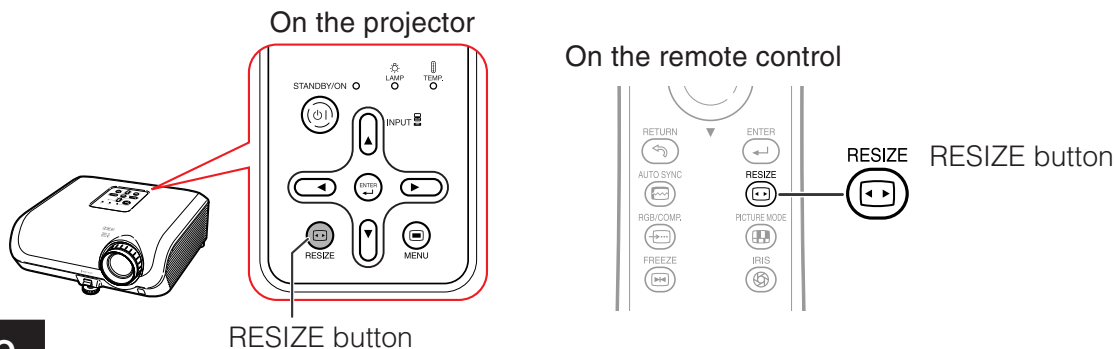

Image Projection (Continued)

Resize Mode

This function allows you to modify or customize the resize mode to enhance the input image. Depending on the input signal, you can choose “STRETCH”, “SIDE BAR”, “CINEMA ZOOM” or “DOT BY DOT (Computer input only)” image.

Press **Ⓜ RESIZE** on the projector or **Ⓜ RESIZE** on the remote control.



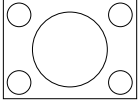
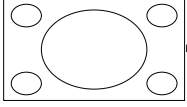
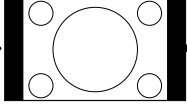
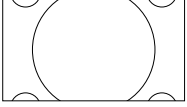
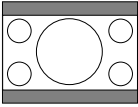
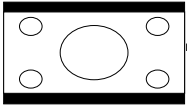
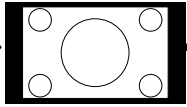
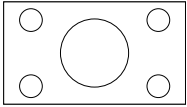
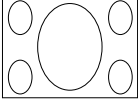
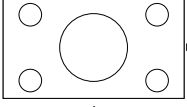
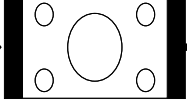
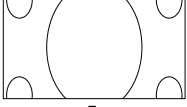
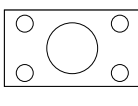
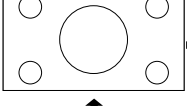
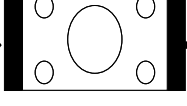
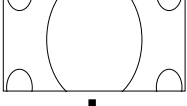
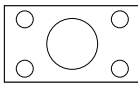
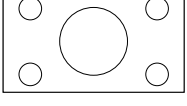

VIDEO

- “STRETCH” is fixed when 540P, 720P or 1080I signals are entered.

| Input Signal | | Output screen image | | |
|--|--|---|--|---|
| DVD / Video | Image type | STRETCH | SIDE BAR | CINEMA ZOOM |
| 480I, 480P, 576I, 576P, NTSC, PAL, SECAM |  4:3 aspect ratio |  |  |  |
| |  Letter box |  |  |  |
| |  Squeezed |  |  |  |
| |  16:9 aspect ratio |  |  |  |
| 540P, 720P, 1080I |  16:9 aspect ratio |  | — | — |

 : Cutout area on which images cannot be projected.

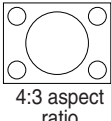
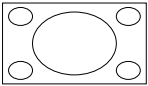
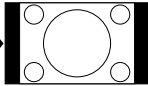
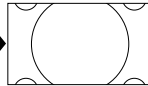
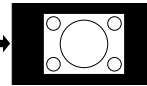
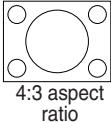
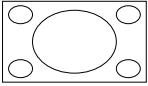
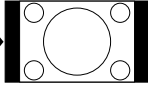
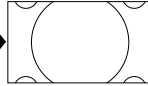
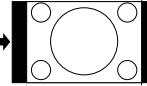
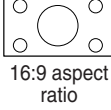
Computer

| Input Signal | | Output screen image | | | |
|---------------------|--|---|--|---|---|
| Computer | Image type | STRETCH | SIDE BAR | CINEMA ZOOM | DOT BY DOT |
| VGA, SVGA |  4:3 aspect ratio |  |  |  |  |
| XGA (1024 × 768) |  4:3 aspect ratio |  |  |  |  |
| 1280 × 720 |  16:9 aspect ratio |  | — | — | — |

 : Cutout area on which images cannot be projected.

Note

- You can select “CINEMA ZOOM” when with a “VGA/SVGA” signal with a vertical frequency 60 Hz and less. However, when a “VGA/SVGA” signal with a vertical frequency of more than 60 Hz is used, “CINEMA ZOOM” is not available.

About Copyrights

- When using the RESIZE function to select an image size with a different aspect ratio to a TV program or video image, the image will look different from its original appearance. Keep this in mind while choosing an image size.
- The use of the Resize, Keystone Correction, Subtitle, or Overscan function to compress or stretch the image for commercial purposes/public displays in a café, hotel, etc. may be an infringement of copyright protected by law for copyright holders. Please use caution.
- While watching non-widescreen images (4:3), if you use the RESIZE function to fill the screen or use the Overscan function to change the aspect ratio of a fixed-ratio input signal, parts of the outer edge of the image will be cut off or distorted. To watch original images as the producers intended, set RESIZE to “SIDE BAR” and Overscan to its default setting.

Operating with the Remote Control

Selecting the Picture Mode

You can select the appropriate picture mode to best match the projected image you are watching.

Press PICTURE MODE.

- When pressing  PICTURE MODE, the picture mode changes in the following order:

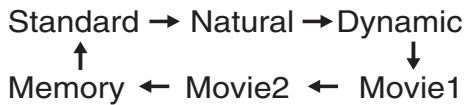

Note

- See page **43** for details on the picture mode.

Switching the Iris Setting

This function controls the quantity of the projected light and the contrast of the image.

Press IRIS.

- Each time the button is pressed while the display is on, the mode is switched in the following order:

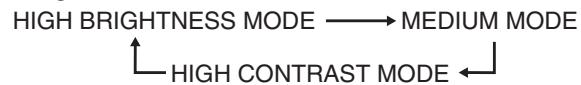

Note

- For details on Iris, see page **45**.

Freezing a Moving Image

1 Press FREEZE.

- The projected image is frozen.

2 Press FREEZE again to return to the moving image from the currently connected device.

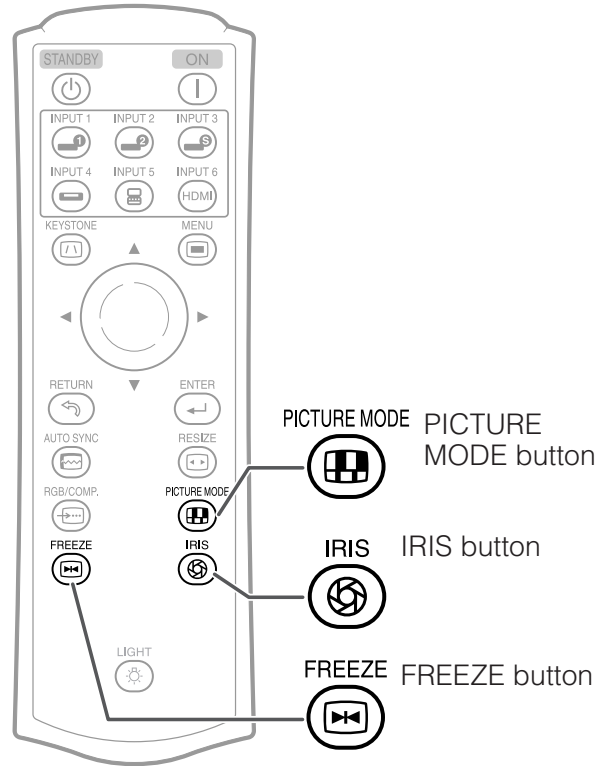

Menu Items

The following shows the items that can be set in the projector. The selectable items vary depending on the selected input, input signals, or adjustment values. Items that cannot be selected will be greyed out.

“Picture” menu

PAGE 1

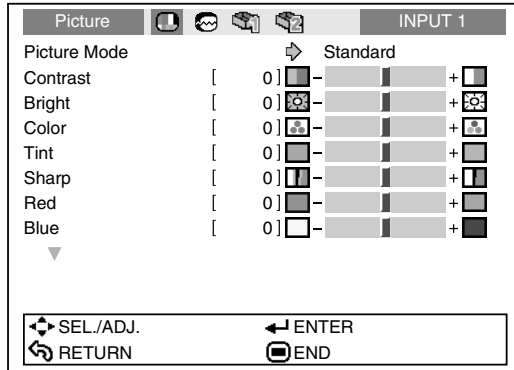

PAGE 2

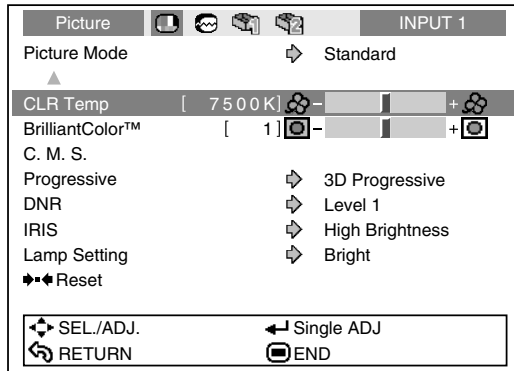

“C.M.S.”

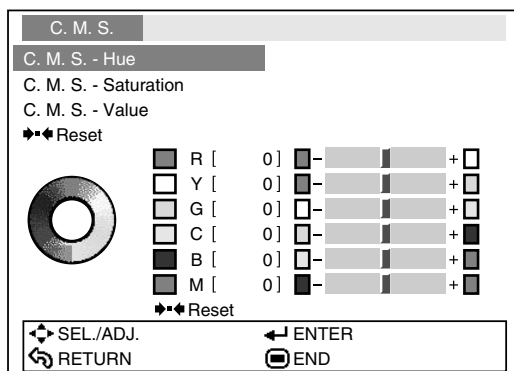

*1 When a video signal, S-video signal, or component 480I/576I signal is input and the Progressive mode is set to “3D Progressive” or “Film Mode”, the C.M.S. function cannot be used.

*2 Item that cannot be set when inputting an RGB signal through INPUT 5 or INPUT 6.

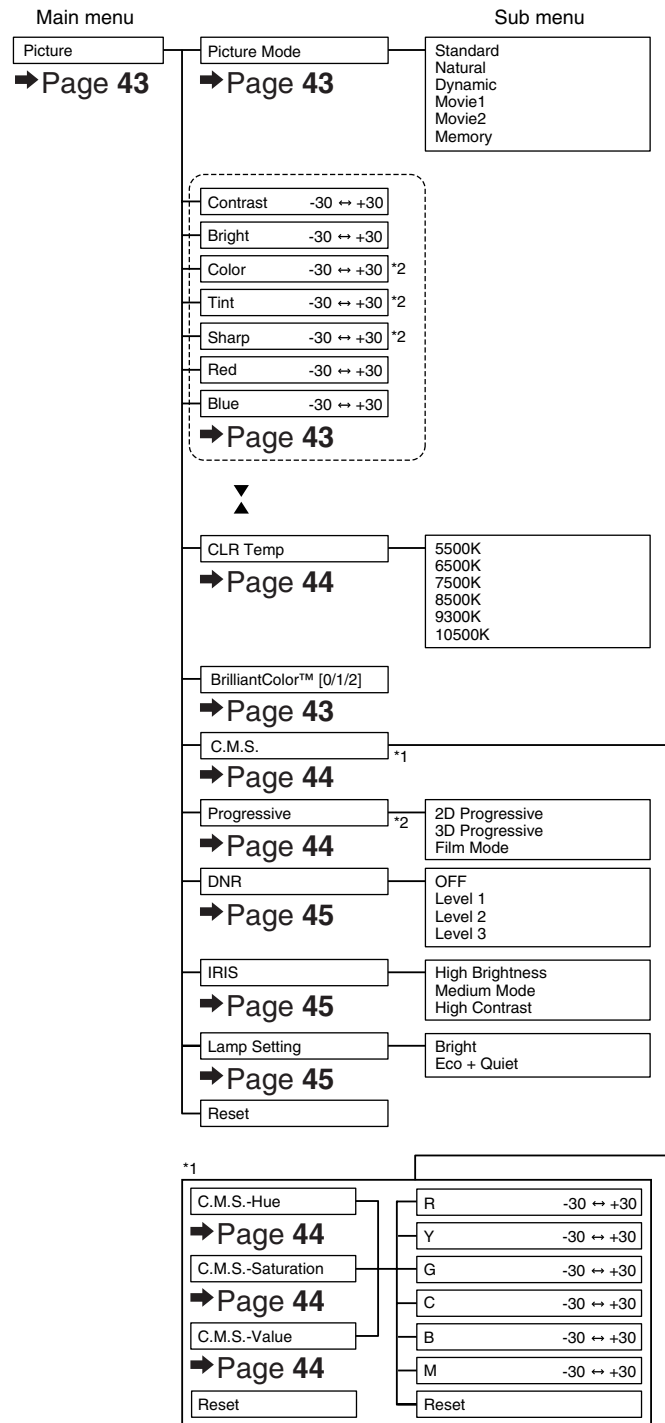

Menu Items (Continued)

“Fine Sync” menu

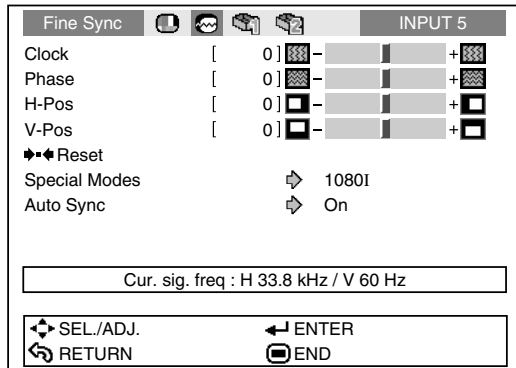

- The “Fine Sync” menu is not available for INPUT 3 or INPUT 4.

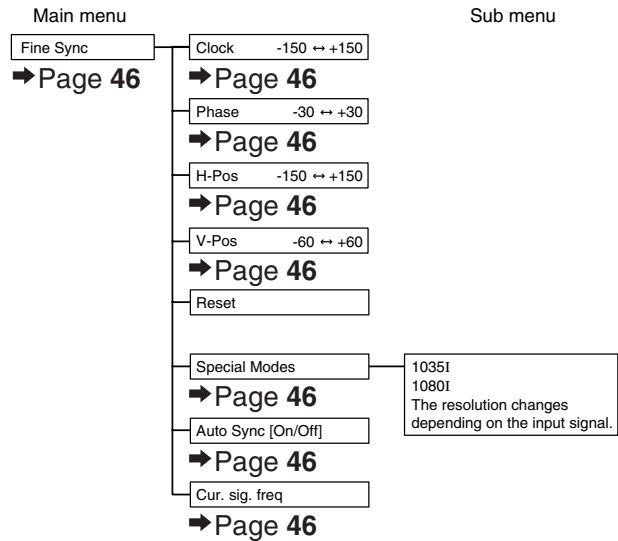

“Options1” menu

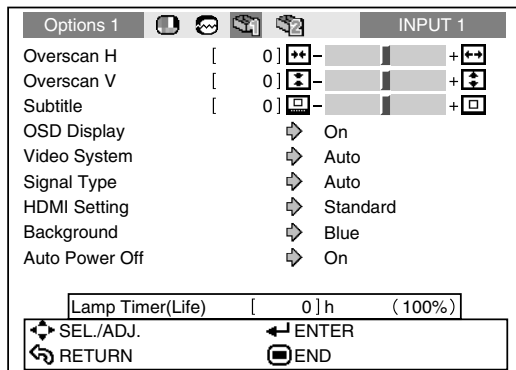

- *1 Item that can be set when using INPUT 3 or INPUT 4.
- *2 Item that can be set when using INPUT 5 or INPUT 6.

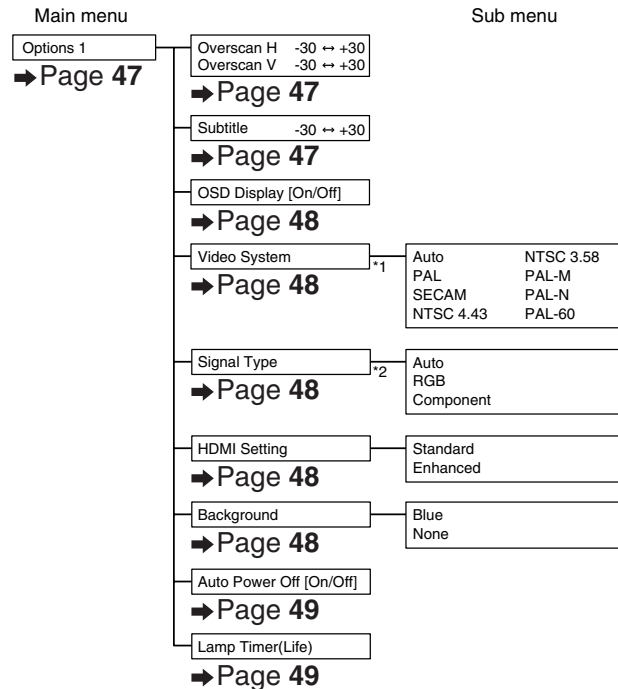

“Options2” menu

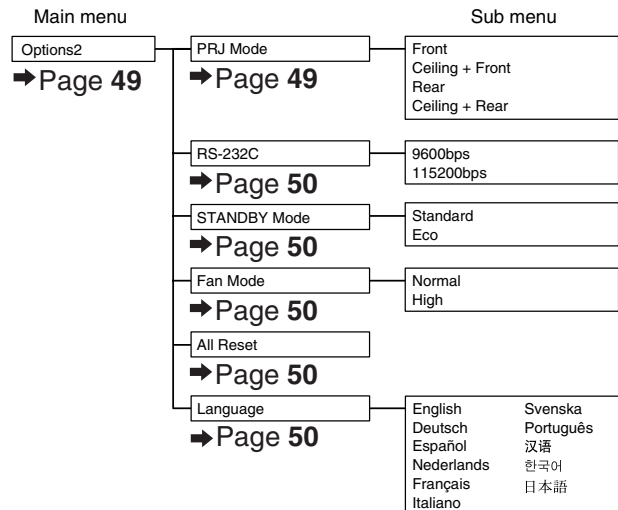
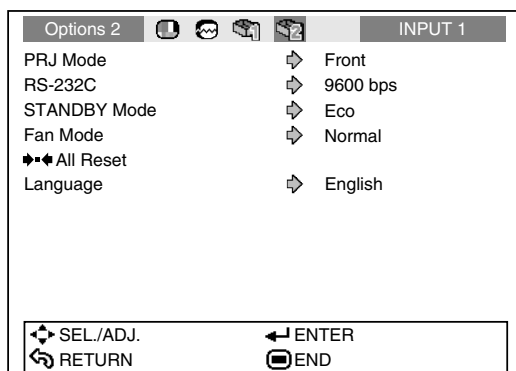

Using the Menu Screen

ENTER button

Adjustment buttons (▲/▼/◀/▶)

MENU button

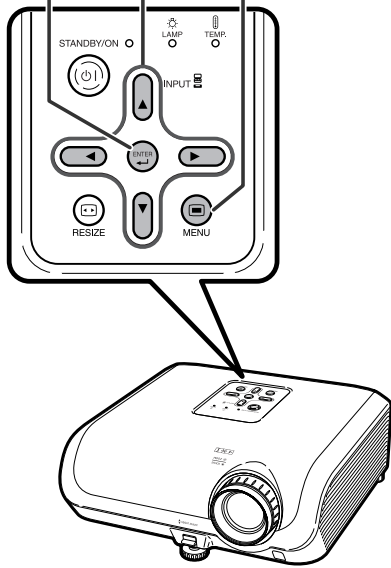

Adjustment buttons (▲/▼/◀/▶)

MENU MENU button

ENTER ENTER button

RETURN RETURN button

- Press RETURN to return to the previous screen when the menu is displayed.

Menu Selections (Adjustments)

Example: Adjusting "Bright".

- This operation can also be performed by using the buttons on the projector.

1 Press MENU.

- The "Picture" menu screen for the selected input mode is displayed.

2 Press or to select the menu icon to adjust.

- The selected icon is highlighted.

| Menu icon | Menu screen |
|-----------|-------------|
| | Picture |
| | Fine Sync |
| | Options1 |
| | Options2 |

Note

- The "Fine Sync" menu is not available for INPUT 3 or INPUT 4.

Example: "Picture" screen menu for INPUT 1 mode

Selected input mode

Menu icons

Picture Mode Standard

Contrast [01]

Bright [01]

Color [01]

Tint [01]

Sharp [01]

Red [01]

Blue [01]

SEL./ADJ. RETURN ENTER END

Useful Features

Using the Menu Screen (Continued)

3 Press ▲ or ▼ to select the item to adjust.

- The selected item is highlighted.

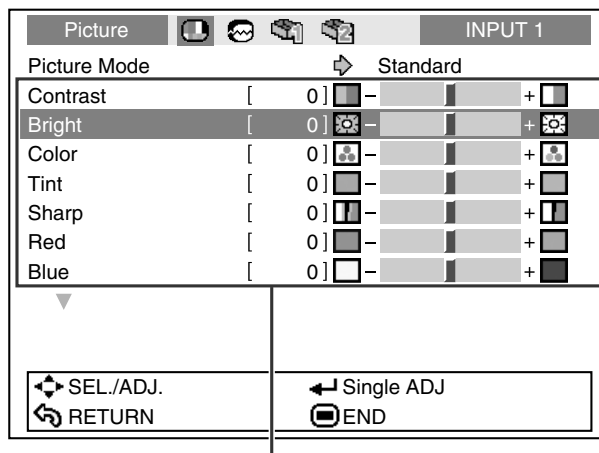

Items to be adjusted

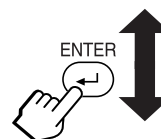

To adjust the projected image while watching it

Press ◀ ENTER.

- The selected item (e.g. "Bright") is displayed by itself at the bottom of the screen.
- When pressing ▲ or ▼, the following item ("Color" after "Bright") will be displayed.

The item displayed by itself



Note

- Press ◀ ENTER again to return to the previous screen.

4 Press ◀ or ▶ to adjust the item selected.

- The adjustment is stored.

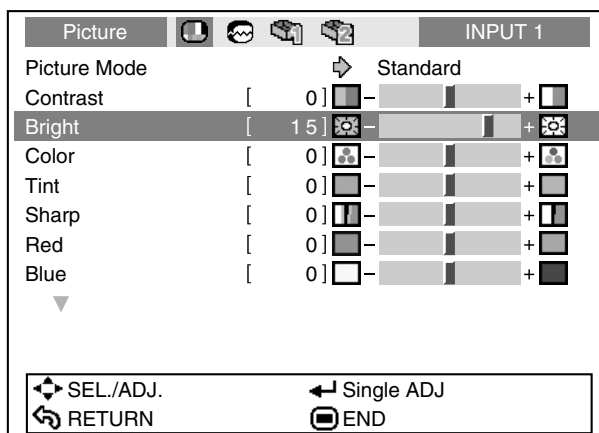

5 Press ◻ MENU.

- The menu screen will disappear.

Note

- The ◻ MENU button does not function while the projector is operating the "Auto Sync" or "FREEZE" functions.

Picture Adjustment (“Picture” menu)

Menu operation → Page 41

▶ PAGE 1

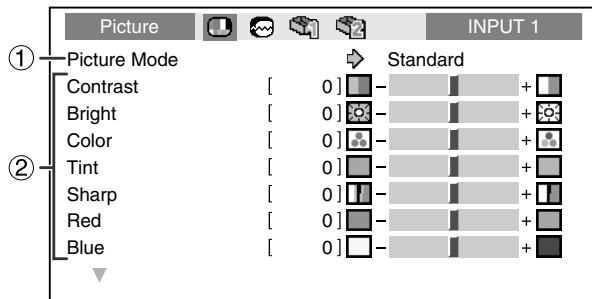

▶ PAGE 2

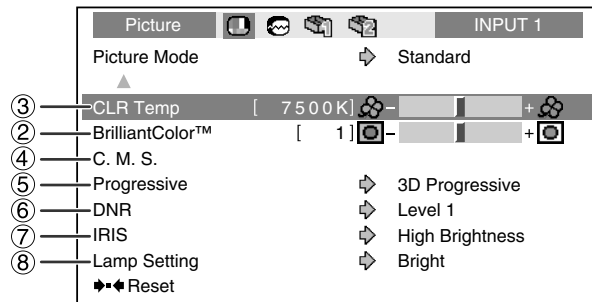

① Selecting the Picture Mode

| Selectable items | Description | The default settings of each item when selecting Picture Mode | | | |
|------------------|---|---|-----------------|-----------------|--------------|
| | | CLR Temp | BrilliantColor™ | IRIS | Lamp Setting |
| Standard | For standard image | 7500K | 0 | High Brightness | Bright |
| Natural | A balanced color image is obtained. | 7500K | 0 | High Brightness | Bright |
| Dynamic | A vivid image is obtained. | 7500K | 2 | High Brightness | Bright |
| Movie1 | Makes the black levels of the dark portions of the screen more pronounced and vivid. | 6500K | 0 | High Brightness | Eco + Quiet |
| Movie2 | Reduces glare and creates a subdued tone. | 6500K | 0 | Medium Mode | Eco + Quiet |
| Memory | Allows you to store your picture adjustment settings. The settings stored effect each input mode. | 7500K | 0 | High Brightness | Bright |

- You can set or adjust each item in the “Picture” menu to your preference. Any changes you make are retained in memory.



- Note**
- You can also press **Ⓟ** PICTURE MODE on the remote control to select the picture mode. (See page 38.)
 - The default settings are subject to change without notice.

② Adjusting the Image

| Adjustment items | ◀ button | ▶ button |
|-------------------------------|---------------------------------|---------------------------------|
| Contrast | For less contrast. | For more contrast. |
| Bright | For less brightness. | For more brightness. |
| Color* ¹ | For less color intensity. | For more color intensity. |
| Tint* ¹ | For making skin tones purplish. | For making skin tones greenish. |
| Sharp* ¹ | For less sharpness. | For more sharpness. |
| Red | For weaker red. | For stronger red. |
| Blue | For weaker blue. | For stronger blue. |
| BrilliantColor™* ² | For making the effect weaker. | For making the effect stronger. |

*¹ Item that cannot be adjusted in RGB mode.

*² BrilliantColor™ uses Texas Instruments' BrilliantColor™ technology. As the BrilliantColor™ level is increased, the image becomes brighter while the color reproduction is kept at a high level.



- Note**
- To reset all adjustment items, select “Reset” and press **Ⓟ**ENTER. The Picture Mode settings of the selected input return to the default settings.

Picture Adjustment (“Picture” menu) (Continued)

Menu operation → Page 41

③ Adjusting the Color Temperature

| Selectable items | Description |
|---|---|
| 5500K 6500K 7500K 8500K 9300K 10500K | For lower color temperature for warmer, reddish incandescent-like images. ↕ For higher color temperature for cooler, bluish, fluorescent-like images. |

Note

- Values on “CLR Temp” are only for general standard purposes.

④ Adjusting the Colors

Select “C.M.S.” (Color Management System) in the “Picture” menu and then press ENTER.

This function adjusts each of the six main colors that comprise the color wheel, altering their “Hue”, “Saturation”, or “Value”.

| Selectable items | Description |
|-------------------|--|
| C.M.S.-Hue | Sets the hue of the main colors. |
| C.M.S.-Saturation | Sets the saturation of the main colors |
| C.M.S.-Value | Sets the brightness of the main colors. |
| Reset | The adjustments of “Hue”, “Saturation” and “Value” of all colors are reset to the default setting. |

Adjusting “Hue”, “Saturation”, or “Value”.

- 1 Press or to select either “Hue”, “Saturation”, or “Value” and then press ENTER.
- 2 Select the color to be adjusted with or and adjust it with or .

Example of adjusting the “Hue”

| Main colors | button | button |
|-------------|-------------------|-------------------|
| R (Red) | Closer to magenta | Closer to yellow |
| Y (Yellow) | Closer to red | Closer to green |
| G (Green) | Closer to yellow | Closer to cyan |
| C (Cyan) | Closer to green | Closer to blue |
| B (Blue) | Closer to cyan | Closer to magenta |
| M (Magenta) | Closer to blue | Closer to red |

- When “Saturation” is selected, the selected color becomes
: lighter. : thicker.
- When “Value” is selected, the selected color becomes
: darker. : brighter.
- To reset the adjustment values of each color to the default settings, select “Reset” and press ENTER.

Info

- When a video signal, S-video signal, or component 480I/576I signal is input, set “Progressive” mode to “2D Progressive” and then adjust the colors.

⑤ Progressive

| Selectable items | Description |
|------------------|---|
| 2D Progressive | Useful to display fast-moving images such as sports. |
| 3D Progressive | Useful to display relatively slow-moving images such as drama and documentary more clearly. |
| Film Mode | Reproduces the image of film source* clearly. Displays the optimized image of film transformed with three-two pull down (NTSC and PAL60Hz) or two-two pull down (PAL50Hz and SECAM) enhancement to progressive mode images. |

* The film source is a digital video recording with the original encoded as is at 24 frames/second. The projector can convert this film source to progressive video at 60 frames/second with NTSC and PAL60Hz or at 50 frames/second with PAL50Hz and SECAM to play back a high-definition image.

Note

- In NTSC or PAL60Hz, even if the 3D Progressive mode has been set, the three-two pull down enhancement will be enabled automatically when the film source has been entered.
- When the image is blurred or noisy, switch to the optimal mode.
- When using progressive inputs, inputs are directly displayed so that 2D Progressive, 3D Progressive and Film Mode cannot be selected.

Info

- The settings can be made either when INPUT3 or INPUT4 are selected or when INPUT1, 2, INPUT5, or INPUT6 are selected and the input signal is 480I or 576I.

⑥ Reducing Image Noise (DNR)

Video digital noise reduction (DNR) provides high quality images with minimal dot crawl and cross color noise.

| Selectable items | Description |
|------------------|---|
| OFF | DNR does not function. |
| Level 1-3 | Sets the DNR level for viewing a clearer picture. |



Note

Set “DNR” to “OFF” in the following cases:

- When the image is blurry.
- When the contours and colors of moving images drag.
- When TV broadcasts with weak signals are projected.

⑦ Switching the Iris Setting

This function controls the quantity of the projected light and the contrast of the image.

| Selectable items | Description |
|------------------|--|
| High Brightness | High brightness is given priority over high contrast. |
| Medium Mode | Intermediate mode between high contrast and high brightness. |
| High Contrast | High contrast is given priority over high brightness. |



Note

- You can also use  IRIS on the remote control to change the Iris. (See page 38.)

⑧ Lamp Setting

| Selectable items | Brightness | Fan sound | Power consumption (When using AC 100V) | Lamp Life |
|------------------|-------------|-----------|--|---------------------|
| Bright | 100% | Normal | 303W | Approx. 2,000 hours |
| Eco + Quiet | Approx. 76% | Low | 234W | Approx. 3,000 hours |



Note

- When “Lamp Setting” is set to “Eco+Quiet”, the power consumption will decrease and the lamp life will extend. (Projection brightness decreases approximately 24%.)

Computer Image Adjustment ("Fine Sync" menu)

Menu operation → Page 41

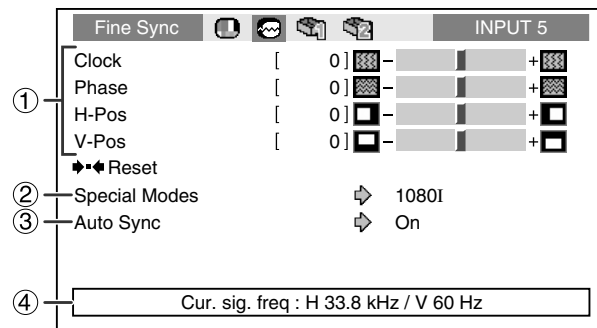

① Adjusting the Computer Image

Use the Fine Sync function in case of irregularities such as vertical stripes or flickering in portions of the screen.

| Selectable items | Description |
|------------------|--|
| Clock | Adjusts vertical noise. |
| Phase | Adjusts horizontal noise (similar to tracking on your VCR). |
| H-Pos | Centers the on-screen image by moving it to the left or right. |
| V-Pos | Centers the on-screen image by moving it up or down. |

Note

- You can automatically adjust the computer image by setting "Auto Sync" in the "Fine Sync" menu to "On" or pressing AUTO SYNC on the remote control.
- "Clock", "Phase", "H-Pos" and "V-Pos" cannot be adjusted when INPUT 6 is selected.
- The adjustable area of each item may be changed according to the input signal.
- To reset all adjustment items, select "Reset" and press ENTER.

② Special Modes Setting

Ordinarily, the type of input signal is detected and the correct resolution mode is automatically selected. However, for some signals, the optimal resolution mode in "Special Modes" in the "Fine Sync" menu may need to be selected to match the computer display mode.

Note

- Avoid displaying computer patterns which repeat every other line (horizontal stripes). (Flickering may occur, making the image hard to see.)
- Information on the currently selected input signal can be confirmed in item ④.

③ Auto Sync (Auto Sync Adjustment)

| Selectable items | Description |
|------------------|---|
| On | Auto Sync adjustment will occur when the projector is turned on or when the input signals are switched, when connected to a computer. |
| Off | Auto Sync adjustment is not automatically performed. |

Note

- Auto Sync adjustment is also performed by pressing AUTO SYNC on the remote control.
- The Auto Sync adjustment may take some time to complete, depending on the image of the computer connected to the projector.
- When the optimum image cannot be achieved with Auto Sync adjustment, use manual adjustments.

④ Checking the Input Signal

This function allows you to check the current input signal information.

Using the “Options” Menu

Menu operation → Page 41

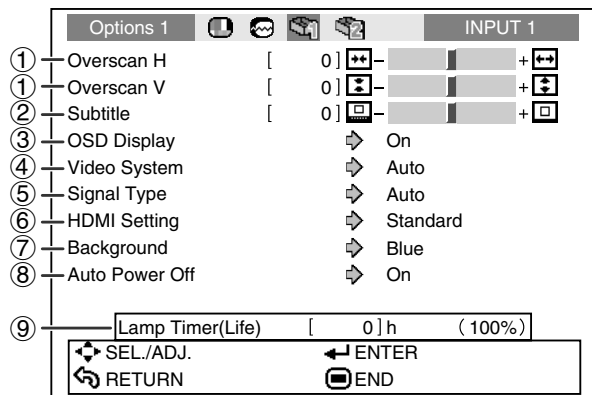

Settings on the Options 1 menu

① Adjusting the Overscan

This function allows you to adjust the Overscan area ratio (display area ratio).

| Orientation | ◀ button | ▶ button |
|-------------------------|---|---|
| Overscan H (Horizontal) | Reduces the image. (The display area ratio becomes larger.) | Enlarges the image. (The display area ratio becomes smaller.) |
| Overscan V (Vertical) | | |

Note

- This function can only be adjusted when a video, S-video, or Component signal is input.
- If the display area ratio is set too large, noise may appear at the screen edges. If this happens, set the display area ratio to a smaller value.
- When “Resize” is set to “CINEMA ZOOM”, depending on the input signal, “Overscan V” may not be adjustable.
- Also read “About Copyrights” on page 37.

② Adjusting the Vertical Size of the Display (Subtitle Setting)

With this function, you can adjust the vertical size of the display to allow for subtitles.

| | |
|----------|--|
| ◀ button | The image is compressed by adjusting the vertical size of the display. |
| ▶ button | The image is enlarged by adjusting the vertical size of the display. |

Note

- When changing the screen with the Subtitle setting, not only the bottom of the screen rises, but also the upper part is changed to a certain point.
- The Subtitle setting can be adjusted more effectively with the Overscan function.
- The Subtitle setting only works when “Resize” is set to “CINEMA ZOOM”.
- The adjustment area changes according to the input signal.

Using the “Options” Menu (Continued)

③ Setting the On-screen Display

| Selectable items | Description |
|------------------|--|
| On | All On-screen Displays are displayed. |
| Off | INPUT/FREEZE/AUTO SYNC/RESIZE/PICTURE MODE/IRIS are not displayed. |

④ Setting the Video System

This function can only be set in INPUT 3 or INPUT 4.

The video input system mode is factory preset to “Auto”; however, a clear picture from the connected audio-visual equipment may not be received, depending on the video signal difference. In that case, switch the video signal.

| Selectable items | Description |
|------------------|---|
| PAL | When connected to PAL video equipment. |
| SECAM | When connected to SECAM video equipment. |
| NTSC4.43 | When reproducing NTSC signals in PAL video equipment. |
| NTSC3.58 | When connected to NTSC video equipment. |

⑤ Signal Type Setting

This function allows you to select the input signal type (RGB or Component) for INPUT 5 or INPUT 6.

| Selectable items | Description |
|------------------|---|
| Auto | Automatically selects the appropriate input signal between RGB and Component. |
| RGB | Set when RGB signals are received. |
| Component | Set when component signals are received. |

Note

- You can also select “Signal Type” using  RGB/COMP. on the remote control (INPUT 5 or INPUT 6).

⑥ Selecting the HDMI Setting

When there is an HDMI-capable device connected to INPUT 6, an optimum picture may not be displayed if the device’s output signal type and the projector’s input signal type do not match. If this should occur, switch the HDMI Setting.

| Selectable items | Description |
|------------------|--|
| Standard | When the black levels of the image show banding or appear faded, select the option that results in the best picture quality. (In most circumstances, “Standard” should be selected.) |
| Enhanced | |

Note

- The HDMI Setting can be selected only when INPUT 6 is selected.

⑦ Selecting the Background Image

| Selectable items | Description |
|------------------|------------------|
| Blue | Blue screen |
| None | — (Black screen) |

⑧ Auto Power Off Function

| Selectable items | Description |
|------------------|---|
| On | When no input signal is detected for more than 15 minutes, the projector will automatically enter standby mode. |
| Off | The Auto Power Off function will be disabled. |

Note

- When the Auto Power Off function is set to “On”, 5 minutes before the projector enters standby mode, the message “Enter STANDBY mode in X min.” will appear on the screen to indicate the remaining minutes.

⑨ Checking the Lamp Life Status

You can confirm the cumulative lamp usage time and the remaining lamp life (percentage).

| Lamp usage condition | Remaining lamp life | | |
|---|---------------------|-------------------|----|
| | “Life” | 100% | 5% |
| Operated exclusively with Lamp Setting set to “Eco + Quiet” | Approx. 3,000 hours | Approx. 150 hours | |
| Operated exclusively with Lamp Setting set to “Bright” | Approx. 2,000 hours | Approx. 100 hours | |

Note

- It is recommended that the lamp be changed when the remaining lamp life becomes 5%.
- The lamp life may vary depending on the usage condition.

| Options 2 | | INPUT 1 | |
|-----------------|---|----------|--|
| ① PRJ Mode | → | Front | |
| ② RS-232C | → | 9600 bps | |
| ③ STANDBY Mode | → | Eco | |
| ④ Fan Mode | → | Normal | |
| ⑤ →↔← All Reset | | | |
| ⑥ Language | → | English | |

Settings on the Options 2 menu

① Reversing/Inverting Projected Images

| Selectable items | Description |
|------------------|--|
| Front | Normal image (Projected from the front of the screen) |
| Ceiling + Front | Inverted image (Projected from the front of the screen with an inverted projector) |
| Rear | Reversed image (Projected from the rear of the screen or with a mirror) |
| Ceiling + Rear | Reversed and inverted image (Projected with a mirror) |

See page 19 for details of Projection (PRJ) Mode.

Using the “Options” Menu (Continued)

Menu operation → Page 41

② Selecting the Transmission Speed (RS-232C)

Make sure that both the projector and computer are set for the same baud rate.

| Selectable items | Description |
|---|------------------------------|
| 9600bps | Transmission speed is slow. |
|  | |
| 115200bps | Transmission speed is rapid. |

③ Reducing the Power Consumption When the Power Is in Standby Mode

When “STANDBY Mode” has been set to “Standard”, the RS-232C function is activated and power is consumed even in standby mode. It is recommended that “STANDBY Mode” be set to “Eco” when it is not being used. This reduces power consumption when the projector is in standby mode.

| Selectable items | Description |
|------------------|---|
| Standard | The RS-232C function is activated even if the projector is in standby mode. |
| Eco | The RS-232C function is switched off when the projector is in standby mode. |

Note

- When you want to control the projector using the RS-232C function, set to “Standard”.

④ Fan Mode Setting

This function changes the fan rotation speed.

| Selectable items | Description |
|------------------|---|
| Normal | Suitable for normal environments. |
| High | Select this when using the projector at altitudes of approximately 4,900 feet (1,500 meters) or more. |

When “Fan Mode” is set to “High”, the fan rotation speeds up, and the fan noise becomes louder.

⑤ Returning to the Default Settings

Use “All Reset” to initialize all the adjustments you have made to the default settings.

Note

The following items cannot be initialized.

- “Fine Sync” menu
 - Special Modes
- “Options1” menu
 - Lamp Timer (Life)
 - Language

⑥ Selecting the On-screen Display Language

The projector can switch the on-screen display language among 11 languages.

| | |
|------------|-----------|
| English | Svenska |
| Deutsch | Português |
| Español | 汉语 |
| Nederlands | 한국어 |
| Français | 日本語 |
| Italiano | |

Maintenance

Cleaning the projector

- Ensure that you have unplugged the power cord before cleaning the projector.
- The cabinet as well as the operation panel is made of plastic. Avoid using benzene or thinner, as these can damage the finish on the cabinet.
- Do not use volatile agents such as insecticides on the projector.
Do not attach rubber or plastic items to the projector for long periods.
The effects of some of the agents in the plastic may cause damage to the quality or finish of the projector.
- Wipe off dirt gently with a soft flannel cloth.
- When the dirt is hard to remove, soak a cloth in a mild detergent diluted with water, wring the cloth well and then wipe the projector. Strong cleaning detergents may discolor, warp or damage the coating on the projector. Make sure to test on a small, inconspicuous area on the projector before use.



Cleaning the lens

- Use a commercially available blower or lens cleaning paper (for glasses and camera lenses) for cleaning the lens. Do not use any liquid type cleaning agents, as they may wear off the coating film on the surface of the lens.
- As the surface of the lens can easily get damaged, be careful not to scrape or hit the lens.

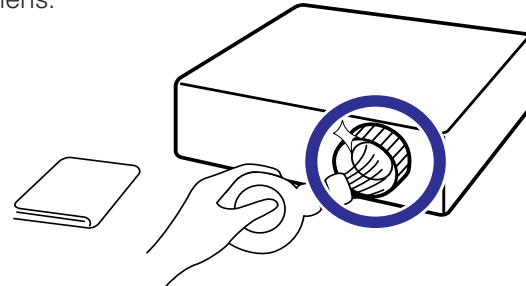

Cleaning the exhaust and intake vents

- Use a vacuum cleaner to clean dust from the exhaust vent and the intake vent.

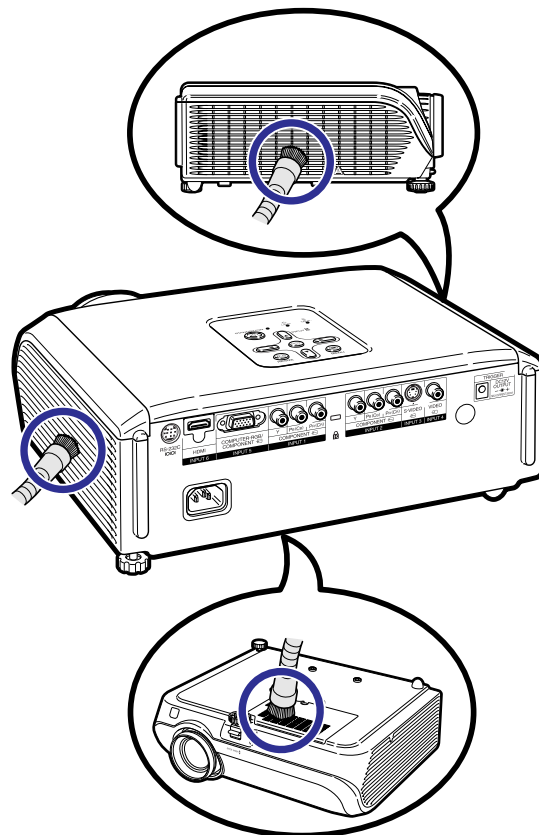

Info

- If you want to clean the air vents during projector operation, ensure you press **⏻** STANDBY/ON on the projector or **⏻** STANDBY on the remote control and put the projector into standby mode. After the cooling fan has stopped, clean the vents.

Cleaning and Replacing the Dust Filters

Cleaning the Dust Filters

Info

- The dust filters should be cleaned every 100 hours of use. Clean the filters more often when the projector is used in a dusty or smoky location.

1 Press STANDBY/ON on the projector to put the projector into standby mode.

- Wait until the cooling fan stops.
- Disconnect the power cord and unplug the power cord from the AC socket.

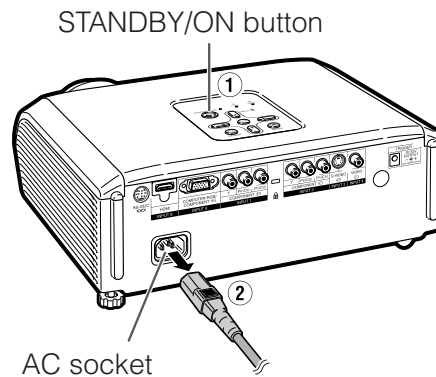

2 Remove the filter holders.

- Turn the projector over. To remove the filter holders, press in the tabs while lifting up.

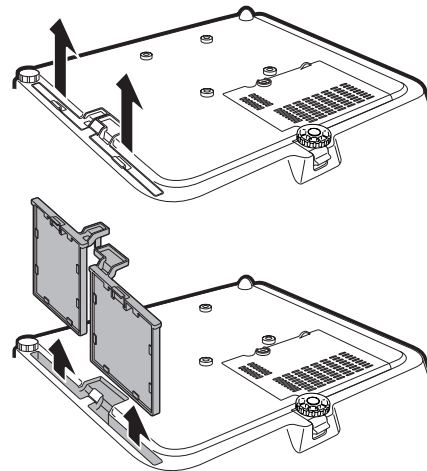

3 Clean the dust off the dust filters and the holders with a hand broom.

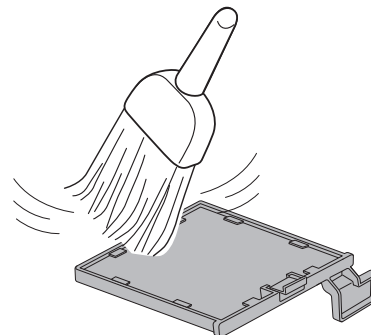

4 Replace the filter holders.

- Align the tabs on the filter holders while replacing them, and then press down on the tabs to lock them in place.

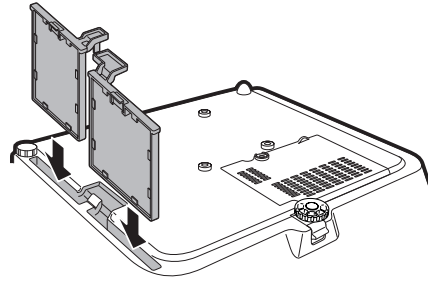

Note

- Be sure the filter holders are securely installed. The power will not turn on unless it is correctly installed.

Replacing the Dust Filters

Info

- If the filters become too dirty to clean effectively, purchase new ones (PFILDA025WJZZ) from your nearest Sharp Authorized Projector Dealer or Service Center.

After removing the filter holders (see step 2 of “Cleaning the Dust Filters”), remove the dust filters, then replace with new ones.

- Pick the dust filters up with your fingers and lift them out of the filter holders.
- With the reinforcement seal facing down, place the dust filters underneath the tabs on the filter holders.

Reinforcement seal

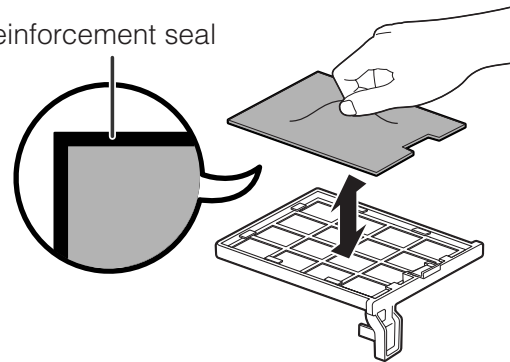

Maintenance Indicators

- The warning lights (power indicator, lamp indicator and temperature warning indicator) on the projector indicate problems inside the projector.
- If a problem occurs, either the temperature warning indicator or the lamp indicator will illuminate red, and the projector will enter standby mode. After the projector has entered standby mode, follow the procedures given below.

Top View

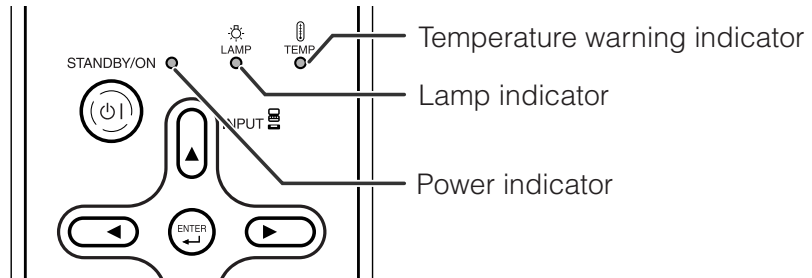

About the temperature warning indicator



If the temperature inside the projector increases, due to blockage of the air vents, or the setting location, "TEMP." will illuminate in the lower left corner of the picture. If the temperature keeps on rising, the lamp will turn off and the temperature warning indicator will blink, the cooling fan will run, and then the projector will enter standby mode. After "TEMP." appears, ensure you perform the measures described on page 55.

About the lamp indicator



■ When the remaining lamp life becomes 5% or less, (yellow) and "Change The Lamp" will be displayed on the screen. When the percentage becomes 0%, it will change to (red), the lamp will automatically turn off and then the projector will automatically enter standby mode. At this time, the lamp indicator will illuminate in red.

■ **If you try to turn on the projector a fourth time without replacing the lamp, the projector will not turn on.**

Indicators on the Projector

| | | |
|-------------------------------|--------------|--|
| Power indicator | Red on | Normal (Standby) |
| | Green on | Normal (Power on) |
| | Red blinks | Abnormal (See page 55.) |
| | Green blinks | Normal (Cooling) |
| Lamp indicator | Green on | Normal |
| | Green blinks | The lamp is warming up or shutting down. |
| | Red on | The lamp is shut down abnormally or requires to be changed. (See page 55.) |
| Temperature warning indicator | Off | Normal |
| | Red on | The internal temperature is abnormally high. (See page 55.) |

| Maintenance indicator | Maintenance indicator | | Problem | Cause | Possible Solution |
|-------------------------------|---|------------------|---|---|---|
| | Normal | Abnormal | | | |
| Temperature warning indicator | Off | Red on (Standby) | The internal temperature is abnormally high. | <ul style="list-style-type: none"> Blocked air intake | <ul style="list-style-type: none"> Relocate the projector to an area with proper ventilation. (See page 8.) |
| | | | | <ul style="list-style-type: none"> Cooling fan breakdown Internal circuit failure Clogged air intake | <ul style="list-style-type: none"> Take the projector to your nearest Sharp Authorized Projector Dealer or Service Center for repair. |
| Lamp indicator | Green on (Green blinks when the lamp is warming up or turning off.) | Red on | The lamp does not illuminate. | <ul style="list-style-type: none"> The lamp is shut down abnormally. | <ul style="list-style-type: none"> Disconnect the power cord from the AC outlet, and then connect it again. |
| | | | Time to change the lamp. | <ul style="list-style-type: none"> Remaining lamp life becomes 5% or less. | <ul style="list-style-type: none"> Carefully replace the lamp. (See page 57.) Take the projector to your nearest Sharp Authorized Projector Dealer or Service Center for repair. |
| | | Red on (Standby) | The lamp does not illuminate. | <ul style="list-style-type: none"> Burnt-out lamp Lamp circuit failure | <ul style="list-style-type: none"> Please exercise care when replacing the lamp. Securely install the cover. |
| Power indicator | Green on/ Red on Green blinks (Cooling) | Red blinks | The power indicator blinks in red when the projector is on. | <ul style="list-style-type: none"> The dust filter holder or lamp unit cover is open. | <ul style="list-style-type: none"> If the power indicator blinks in red even when the dust filter holders and lamp unit cover are securely installed, contact your nearest Sharp Authorized Projector Dealer or Service Center for advice. |

Info

- If the temperature warning indicator illuminates, and the projector enters standby mode, follow the possible solutions above and then wait until the projector has cooled down completely before plugging in the power cord and turning the power back on. (At least 10 minutes.)
- If the power is turned off for a brief moment due to power outage or some other cause while using the projector, and the power supply recovers immediately after that, the lamp indicator will illuminate in red and the lamp may not be lit. In this case, unplug the power cord from the AC outlet, replace the power cord in the AC outlet and then turn the power on again.
- The cooling fan keeps the internal temperature of the projector constant and this function is controlled automatically. The sound of the cooling fan may change during operation because the fan speed may change and this is not a malfunction.
- Do not unplug the power cord after the projector has entered standby mode and while the cooling fan is running. The cooling fan runs for about 90 seconds.

Regarding the Lamp

Lamp

- It is recommended that the lamp (sold separately) be replaced when the remaining lamp life becomes 5% or less, or when you notice a significant deterioration in the picture and color quality. The lamp life (percentage) can be checked with the on-screen display. (See page 49.)
- Purchase a replacement lamp of type AN-XR10L2 from your place of purchase, nearest Sharp Authorized Projector Dealer or Service Center.

Caution Concerning the Lamp

- This projector utilizes a pressurized mercury lamp. A loud sound may indicate lamp failure. Lamp failure can be attributed to numerous sources such as: excessive shock, improper cooling, surface scratches or deterioration of the lamp due to a lapse of usage time.
The period of time up to failure largely varies depending on the individual lamp and/or the condition and the frequency of use. It is important to note that failure can often result in the bulb cracking.
- When the lamp replacement indicator and on-screen display icon are illuminated, it is recommended that the lamp be replaced with a new one immediately, even if the lamp appears to be operating normally.
- Should the lamp break, there is also a possibility that glass particles may spread inside of the projector. In such a case, it is recommended you contact your nearest Sharp Authorized Projector Dealer or Service Center to assure safe operation.
- Should the lamp break, the glass particles may spread inside the lamp cage or gas contained in the lamp may be vented into the room from the exhaust vent. Because the gas in this lamp includes mercury, ventilate the room well if the lamp breaks and avoid all exposure to the released gas. In case of exposure to the gas, consult a doctor as soon as possible.

Replacing the Lamp

- Do not remove the lamp unit from the projector right after use. The lamp will be very hot and may cause burn or injury.
- **Carefully change the lamp by following the instructions described in this section. * If you wish, you may have the lamp replaced at your nearest Sharp Authorized Projector Dealer or Service Center.**

* If the new lamp does not light after replacement, take your projector to the nearest Sharp Authorized Projector Dealer or Service Center for repair.

Removing and Installing the Lamp Unit

Warning!

- The lamp unit becomes very hot while the projector is operating. Do not remove the lamp unit from the projector right after use. The lamp and parts around the lamp will be very hot and may cause burns or injury.

Info

- Make sure that you remove the lamp unit by the handle. Do not touch the glass surface of the lamp unit or the inside of the projector.
- To avoid injury to yourself and damage to the lamp, make sure you carefully follow the steps below.
- Do not loosen other screws except for the lamp unit cover and lamp unit.

1 Press  **STANDBY/ON** on the projector or  **STANDBY** on the remote control to put the projector into standby mode.

- Wait until the cooling fan stops.

2 **Disconnect the power cord.**

- Unplug the power cord from the AC socket.
- Leave the lamp until it has fully cooled down (about 1 hour).

3 **Remove the lamp unit cover.**

- Turn the projector over. Loosen the user service screw (①) that secures the lamp unit cover. Remove the lamp unit cover (②).

Optional
accessory

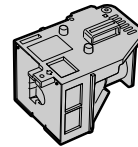

Lamp unit
AN-XR10L2

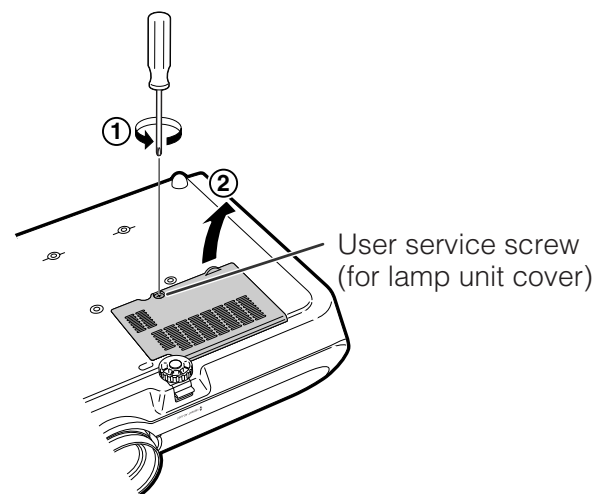
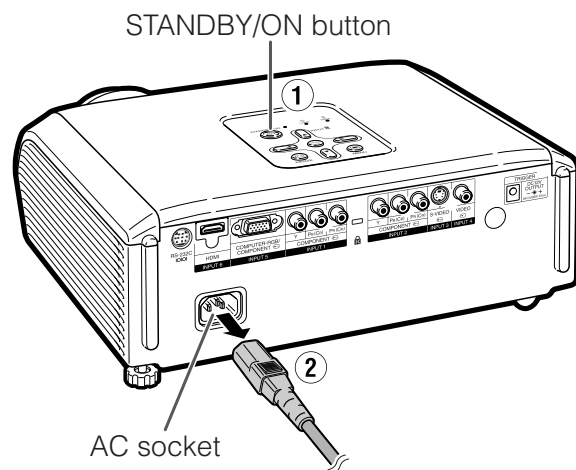

Regarding the Lamp (Continued)

4 Remove the lamp unit.

- Loosen the securing screws from the lamp unit. Hold the lamp unit by the handle and pull it in the direction of the arrow. At this time, keep the lamp unit horizontal and do not tilt it.

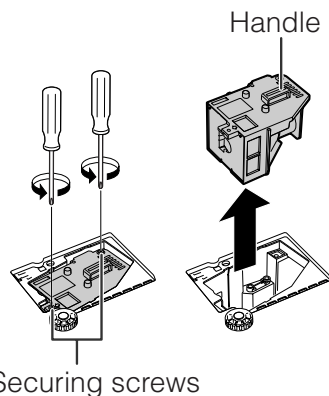

5 Insert the new lamp unit.

- Press the lamp unit firmly into the lamp unit compartment. Fasten the securing screws.

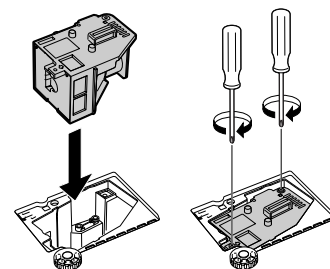

6 Replace the lamp unit cover.

- Align the tab on the lamp unit cover (1) and place it while pressing the tab (2) to close it. Then tighten the user service screw (3) to secure the lamp unit cover.

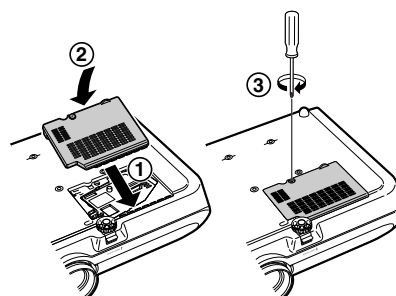

Info

- If the lamp unit and lamp unit cover are not correctly installed, the power will not turn on, even if the power cord is connected to the projector.

Resetting the Lamp Timer

Reset the lamp timer after replacing the lamp.

Info



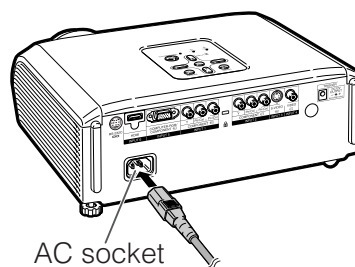

- Make sure to reset the lamp timer only when replacing the lamp. If you reset the lamp timer and continue to use the same lamp, this may cause the lamp to become damaged or explode.

1 Connect the power cord.

- Plug the power cord into the AC socket of the projector.



2 Reset the lamp timer.

- While simultaneously holding down  MENU,  ENTER and  on the projector, press  STANDBY/ON on the projector.
- "LAMP 0000H" is displayed, indicating that the lamp timer is reset.

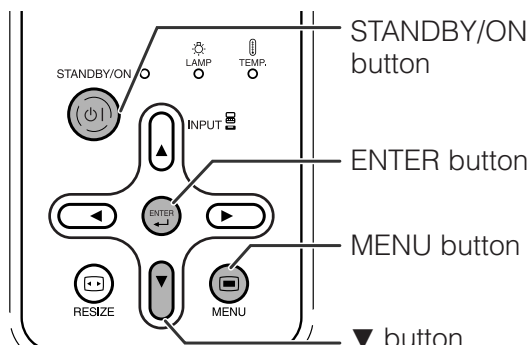

Connecting Pin Assignments

COMPUTER-RGB/COMPONENT INPUT5 Terminal: 15-pin Mini D-sub female connector

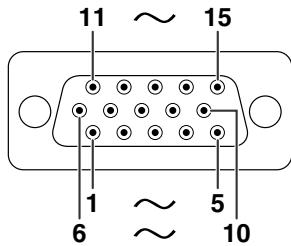

COMPUTER-RGB Input

1. Video input (red)
2. Video input (green/sync on green)
3. Video input (blue)
4. Not connected
5. Not connected
6. Earth (red)
7. Earth (green/sync on green)
8. Earth (blue)
9. Not connected
10. GND
11. Not connected
12. Bi-directional data
13. Horizontal sync signal: TTL level
14. Vertical sync signal: TTL level
15. Data clock

Component Input

1. PR (CR)
2. Y
3. PB (CB)
4. Not connected
5. Not connected
6. Earth (PR)
7. Earth (Y)
8. Earth (PB)
9. Not connected
10. Not connected
11. Not connected
12. Not connected
13. Not connected
14. Not connected
15. Not connected

RS-232C Terminal: 9-pin Mini DIN female connector

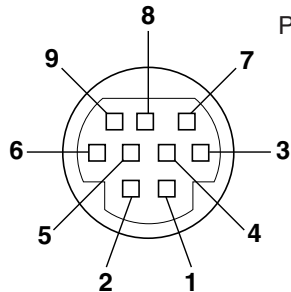

| Pin No. | Signal | Name | I/O | Reference |
|---------|--------|-----------------|--------|-------------------------------------|
| 1. | | | | Not connected |
| 2. | RD | Receive Data | Input | Connected to internal circuit |
| 3. | SD | Send Data | Output | Connected to internal circuit |
| 4. | | | | Not connected |
| 5. | SG | Signal Ground | | Connected to internal circuit |
| 6. | | | | Not connected |
| 7. | RS | Request to Send | | Connected to CS in internal circuit |
| 8. | CS | Clear to Send | | Connected to RS in internal circuit |
| 9. | | | | Not connected |

RS-232C Terminal: 9-pin D-sub male connector of the DIN-D-sub RS-232C adaptor (optional accessory: AN-A1RS)

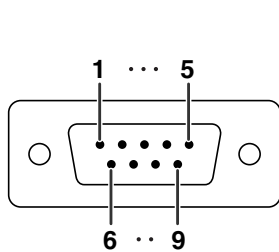

| Pin No. | Signal | Name | I/O | Reference |
|---------|--------|-----------------|--------|-------------------------------------|
| 1. | | | | Not connected |
| 2. | RD | Receive Data | Input | Connected to internal circuit |
| 3. | SD | Send Data | Output | Connected to internal circuit |
| 4. | | | | Not connected |
| 5. | SG | Signal Ground | | Connected to internal circuit |
| 6. | | | | Not connected |
| 7. | RS | Request to Send | | Connected to CS in internal circuit |
| 8. | CS | Clear to Send | | Connected to RS in internal circuit |
| 9. | | | | Not connected |

RS-232C Cable recommended connection: 9-pin D-sub female connector

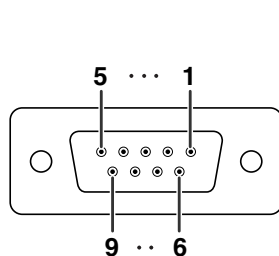

| Pin No. | Signal | Pin No. | Signal |
|---------|--------|---------|--------|
| 1. | CD | 1. | CD |
| 2. | RD | 2. | RD |
| 3. | SD | 3. | SD |
| 4. | ER | 4. | ER |
| 5. | SG | 5. | SG |
| 6. | DR | 6. | DR |
| 7. | RS | 7. | RS |
| 8. | CS | 8. | CS |
| 9. | CI | 9. | CI |

Note

- Depending on the controlling device used, it may be necessary to connect Pin 4 and Pin 6 on the controlling device (e.g. computer).

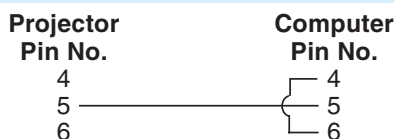

Connecting Pin Assignments (Continued)

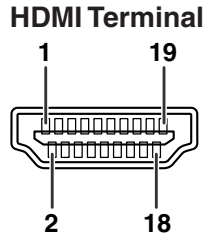

| Pin No. | Name | Pin No. | Name | Pin No. | Name |
|---------|-------------------|---------|-------------------|---------|-----------------|
| 1. | TMDS Data2+ | 8. | TMDS Data0 Shield | 14. | Reserved |
| 2. | TMDS Data2 Shield | 9. | TMDS Data0- | 15. | SCL |
| 3. | TMDS Data2- | 10. | TMDS Clock+ | 16. | SDA |
| 4. | TMDS Data1+ | 11. | TMDS Clock Shield | 17. | DDC/CEC Ground |
| 5. | TMDS Data1 Shield | 12. | TMDS Clock- | 18. | +5V Power |
| 6. | TMDS Data1- | 13. | CEC | 19. | Hot Plug Detect |
| 7. | TMDS Data0+ | | | | |

RS-232C Specifications and Command Settings

Computer control

A computer can be used to control the projector by connecting an RS-232C serial control cable (cross type, sold separately) to the projector. (See page 27 for connection.)

Communication conditions

Set the serial port settings of the computer to match that of the table.

Signal format: Conforms to RS-232C standard.

Parity bit: None

Baud rate: * 9,600 bps/115,200 bps

Stop bit: 1 bit

Data length: 8 bits

Flow control: None

* Set the projector's baud rate to the same rate as used by the computer.

Basic format

Commands from the computer are sent in the following order: command, parameter, and return code. After the projector processes the command from the computer, it sends a response code to the computer.

Command format

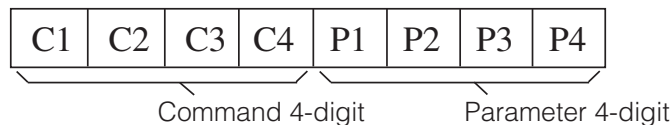

Response code format

Normal response



Problem response

(communication error or incorrect command)



Info

- When controlling the projector using RS-232C commands from a computer, wait for at least 30 seconds after the power has been turned on, and then transmit the commands.
- When more than one code is being sent, send each command only after the response code for the previous command from the projector is verified.

Commands

Example: When turning on the projector, make the following setting.



| CONTROL CONTENTS | COMMAND | PARAMETER | RETURN |
|--------------------------------|---------|-----------|-------------|
| Power Off | P O W R | _ _ _ | 0 OK or ERR |
| Power On | P O W R | _ _ _ | 1 OK or ERR |
| INPUT 1 (Video1 : Component1) | I V E D | _ _ _ | 1 OK or ERR |
| INPUT 2 (Video2 : Component2) | I V E D | _ _ _ | 2 OK or ERR |
| INPUT 3 (Video3 : S-Video) | I V E D | _ _ _ | 3 OK or ERR |
| INPUT 4 (Video4 : Video) | I V E D | _ _ _ | 4 OK or ERR |
| INPUT 5 (RGB1 : RGB/Component) | I R G B | _ _ _ | 1 OK or ERR |
| INPUT 6 (RGB2 : RGB/Component) | I R G B | _ _ _ | 2 OK or ERR |

Note

- If an underbar (_) appears in the parameter column, enter a space.

Computer Compatibility Chart

Computer

- Multiple signal support
Horizontal Frequency: 15-70 kHz,
Vertical Frequency: 45-85 Hz,
Pixel Clock: 12-85 MHz
Sync signal: Compatible with TTL level
- Compatible with sync on green signal
- Expansion System resizing technology

The following is a list of modes that conform to VESA. However, this projector supports other signals that are not VESA standards.

| PC/MAC | Resolution | Horizontal Frequency (kHz) | Vertical Frequency (Hz) | VESA Standard | HDMI Support | Display | |
|---------|-------------|----------------------------|-------------------------|---------------|--------------|-------------------------|---|
| PC | VGA | 640 × 350 | 27.0 | 60 | | Upscale | |
| | | | 31.5 | 70 | | | |
| | | | 37.5 | 85 | ✓ | | |
| | | 640 × 400 | 27.0 | 60 | | | |
| | | | 31.5 | 70 | | | |
| | | | 37.9 | 85 | ✓ | | |
| | 720 × 350 | 27.0 | 60 | | | | |
| | | 31.5 | 70 | | | | |
| | | 37.9 | 85 | ✓ | | | |
| | 720 × 400 | 27.0 | 60 | | | | |
| | | | 31.5 | 70 | | | |
| | | | 37.9 | 85 | ✓ | | |
| | | 640 × 480 | 26.2 | 50 | | | |
| | | | 31.5 | 60 | ✓ | | ✓ |
| | | | 34.7 | 70 | | | |
| | SVGA | 800 × 600 | 37.9 | 72 | ✓ | | |
| | | | 37.5 | 75 | ✓ | | |
| | | | 43.3 | 85 | ✓ | | |
| | | | 31.4 | 50 | | | |
| | | | 35.1 | 56 | ✓ | | |
| | | | 37.9 | 60 | ✓ | | |
| | | | 46.6 | 70 | ✓ | | |
| | | | 48.1 | 72 | ✓ | | |
| | | | 46.9 | 75 | ✓ | | |
| 53.7 | | | 85 | ✓ | | | |
| XGA | 1,024 × 768 | 40.3 | 50 | | | | |
| | | 48.4 | 60 | ✓ | | | |
| | | 56.5 | 70 | ✓ | | | |
| | | 60.0 | 75 | ✓ | | | |
| | | 45.0 | 60 | | | | |
| — | 1,280 × 720 | 47.8 | 60 | | | | |
| — | 1,280 × 768 | 47.8 | 60 | | | | |
| MAC 13" | VGA | 640 × 480 | 34.9 | 67 | | Intelligent compression | |
| MAC 16" | SVGA | 800 × 600 | 37.8 | 60 | | Upscale | |
| | | 832 × 624 | 49.7 | 75 | | | |
| MAC 19" | XGA | 1,024 × 768 | 60.2 | 75 | | Intelligent compression | |





Note

- When this projector receives 640 × 350 VESA format VGA signals, “640 × 400” appears on the screen.

DTV

| Signal | Horizontal Frequency (kHz) | Vertical Frequency (Hz) | HDMI Support |
|--------|----------------------------|-------------------------|--------------|
| 480I | 15.7 | 60 | ✓ |
| 480P | 31.5 | 60 | ✓ |
| 540P | 33.8 | 60 | |
| 576I | 15.6 | 50 | ✓ |
| 576P | 31.3 | 50 | ✓ |
| 720P | 37.5 | 50 | ✓ |
| 720P | 45.0 | 60 | ✓ |
| 1035I | 28.1 | 50 | |
| 1035I | 33.8 | 60 | |
| 1080I | 28.1 | 50 | ✓ |
| 1080I | 33.8 | 60 | ✓ |

Troubleshooting

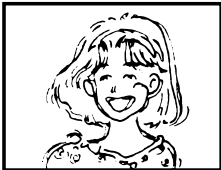
| Problem | Check | Page |
|---|--|-----------------------------|
|  <p>Picture does not appear or projector does not start.</p> | <ul style="list-style-type: none"> Projector power cord is not plugged into the wall outlet. | 28 |
| | <ul style="list-style-type: none"> Power to the external connected devices is off. | – |
| | <ul style="list-style-type: none"> The selected input mode is wrong. | 29 |
| | <ul style="list-style-type: none"> Cables incorrectly connected to the projector. | 23–27 |
| | <ul style="list-style-type: none"> Remote control battery has run out. | 14 |
| | <ul style="list-style-type: none"> External output has not been set when connecting notebook computer. | 26 |
| | <ul style="list-style-type: none"> The lamp unit cover is not installed correctly. | 57, 58 |
| | <ul style="list-style-type: none"> The dust filter holders are not installed correctly. | 52, 53 |
|  <p>No picture appears (or picture is dark).</p> | <ul style="list-style-type: none"> Cables incorrectly connected to the projector. | 23–27 |
| | <ul style="list-style-type: none"> “Bright” is set to minimum position. <p>Depending on the computer you are using, an image may not be projected unless the signal output setting of the computer is switched to the external output. Refer to the computer’s operation manual for how to switch its signal output settings.</p> | 43 – |
|  <p>Color is faded or poor.</p> | <ul style="list-style-type: none"> Image adjustments are incorrectly set. Make adjustments to “Color”, “Tint” and “BrilliantColor™” in “Picture Mode”. | 43 |
| | <p>(Video Input only)</p> <ul style="list-style-type: none"> Video input system is incorrectly set. | 48 |
|  <p>Picture is blurred; noise appears.</p> | <ul style="list-style-type: none"> Adjust the focus. | 30 |
| | <ul style="list-style-type: none"> The projection distance exceeds the focus range. | 20 |
| | <ul style="list-style-type: none"> There is fog on the lens. If the projector is carried from a cold room into a warm room, or if it is suddenly heated, condensation may form on the surface of the lens and the image will become blurred. Please set up the projector at least one hour before it is to be used. If condensation should form, remove the power cord from the wall outlet and wait for it to clear. | – |
| | <p>(Computer Input only)</p> <ul style="list-style-type: none"> Perform “Fine Sync” Adjustments (“Clock” Adjustment) Perform “Fine Sync” Adjustments (“Phase” Adjustment) Noise may appear depending on the computer. | 46 46 – |
| <p>Picture is green on INPUT 5 (Component)/INPUT 6 (Component).</p> | <ul style="list-style-type: none"> Select “Signal Type” in the “Options1” menu and change the input signal type. | 48 |
| <p>Picture is pink (no green) on INPUT 5 (RGB)/INPUT 6 (RGB).</p> | | |
| <p>An unusual sound is occasionally heard from the cabinet.</p> | <ul style="list-style-type: none"> If the picture is normal, the sound is due to cabinet shrinkage caused by room temperature changes. This will not affect operation or performance. | – |
| <p>Maintenance indicator on the projector illuminates or blinks in red.</p> | <ul style="list-style-type: none"> See “Maintenance Indicators”. | 54 |

| Problem | Check | Page |
|--|--|-----------------------|
| Picture is too bright and whitish. | <ul style="list-style-type: none"> Image adjustments are incorrectly set. | 43 |
| The black levels of the image show banding or appear faded when INPUT 6 is selected. | <ul style="list-style-type: none"> Select the HDMI Setting (“Standard” or “Enhanced”) that results in the best picture quality. | 48 |
| The cooling fan becomes noisy. | <ul style="list-style-type: none"> When temperature inside the projector increases, the cooling fan runs faster. | 8, 9 51-55 |
| The lamp does not light up even after the projector turns on. | <ul style="list-style-type: none"> The lamp indicator is illuminating in red. Replace the lamp. | 54, 57 |
| The lamp suddenly turns off during projection. | | |
| The image sometimes flickers. | <ul style="list-style-type: none"> Cables incorrectly connected to the projector or the connected equipment works improperly. If this happens frequently, replace the lamp. | 23-27 57 |
| The lamp needs much time to turn on. | <ul style="list-style-type: none"> The lamp will eventually need to be changed. While the remaining lamp life draws to a close, replace the lamp. | 57 |
| Picture is dark. | | |
| The remote control cannot be used. | <ul style="list-style-type: none"> Operate the remote control while pointing it at the projector’s remote control sensor. The remote control may be too far away from the projector. If direct sunlight or a strong fluorescent light is shining on the projector’s remote control sensor, place the projector where it will not be affected by strong light. | 15 |
| | <ul style="list-style-type: none"> The batteries may be depleted or inserted incorrectly. Make sure the batteries are inserted correctly or insert new ones. | 14 |

This unit is equipped with a microprocessor. Its performance could be adversely affected by incorrect operation or interference. If this should happen, unplug the Unit and plug it in again after more than 5 minutes.

Specifications

| | |
|--|--|
| Product type | Projector |
| Model | XV-Z3100 |
| Video system | NTSC3.58/NTSC4.43/PAL/PAL-M/PAL-N/PAL-60/SECAM/DTV480I/DTV480P/ DTV540P/DTV576I/DTV576P/DTV720P/DTV1035I/DTV1080I/DTV1080I-50 |
| Display method | DLP® chip Panel size: 0.62" Drive method: Digital Light Processing (DLP®) No. of dots: 921,600 dots (1280 [H] × 720 [V]) |
| Lens | 1–1.15 × zoom lens, F2.4–2.6, f = 19.0–21.9 mm |
| Projection lamp | 220 W DC lamp |
| Component input signal (INPUT 1/2) | RCA connector Y: 1.0 Vp-p, sync negative, 75 Ω terminated P _B (C _B): 0.7 Vp-p, 75 Ω terminated P _R (C _R): 0.7 Vp-p, 75 Ω terminated |
| S-video input signal (INPUT 3) | 4-pin mini DIN connector Y (luminance signal): 1.0 Vp-p, sync negative, 75 Ω terminated C (chrominance signal): Burst 0.286 Vp-p, 75 Ω terminated |
| Video input signal (INPUT 4) | RCA connector: VIDEO, composite video, 1.0 Vp-p, sync negative, 75 Ω terminated |
| Computer RGB/ Component input signal (INPUT 5) | 15-pin mini D-sub connector RGB separate/sync on green type analog input: 0–0.7 Vp-p, positive, 75 Ω terminated HORIZONTAL SYNC. SIGNAL: TTL level (positive/negative) VERTICAL SYNC. SIGNAL: Same as above |
| HDMI input signal (INPUT 6) | HDMI terminal (video signal only) |
| Horizontal resolution | 720 TV lines (DTV720P) |
| Vertical frequency | 45–85 Hz |
| Horizontal frequency | 15–70 kHz |
| Pixel clock | 12–85 MHz |
| RS-232C terminal | 9-pin mini DIN connector |
| TRIGGER terminal | Power jack: DC 12V output |
| Rated voltage | AC 100–240 V |
| Input current | 3.1 A |
| Rated frequency | 50/60 Hz |
| Power consumption | 303 W (Lamp Setting “Bright”)/ 234 W (Lamp Setting “Eco + Quiet”) with AC 100 V 293 W (Lamp Setting “Bright”)/ 228 W (Lamp Setting “Eco + Quiet”) with AC 240 V |
| Power consumption (standby) | 4 W (AC 100 V) – 5 W (AC 240 V)*1 |
| Heat dissipation | 1,140 BTU/hour (Lamp Setting “Bright”)/ 1,100 BTU/hour (Lamp Setting “Eco + Quiet”) with AC 100 V 880 BTU/hour (Lamp Setting “Bright”)/ 860 BTU/hour (Lamp Setting “Eco + Quiet”) with AC 240 V |
| Operating temperature | 41°F to 95°F (+5°C to +35°C) |
| Storage temperature | –4°F to 140°F (–20°C to +60°C) |
| Cabinet | Plastic |
| I/R carrier frequency | 38 kHz |
| Dimensions (approx.) | 12 13/32" × 4 19/64" × 11 1/32" (315 (W) × 109 (H) × 280 (D) mm) (main body only) 12 13/32" × 4 47/64" × 11 37/64" (315 (W) × 120 (H) × 294 (D) mm) (including adjust- ment foot and projecting parts) |
| Weight (approx.) | 8.8 lbs. (4.0 kg) |
| Replacement parts | Remote control, Power cord for Europe, except U.K., Power cord for U.K. and Singapore, Power cord for Australia, New Zealand and Oceania, 21 pin RCA conversion adaptor, Video cable, Operation manual |

*1 When STANDBY Mode is set to “Eco”

As a part of policy of continuous improvement, SHARP reserves the right to make design and specification changes for product improvement without prior notice. The performance specification figures indicated are nominal values of production units. There may be some deviations from these values in individual units.

Dimensions

Units: inches (mm)

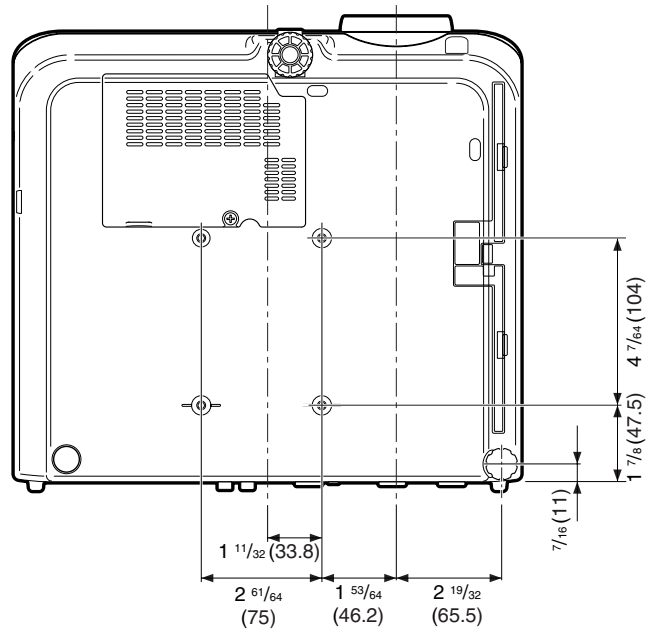
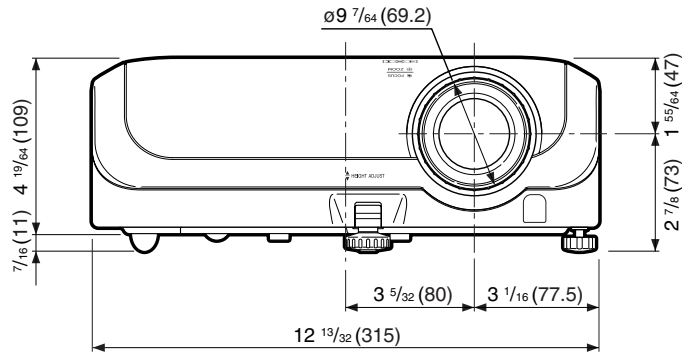
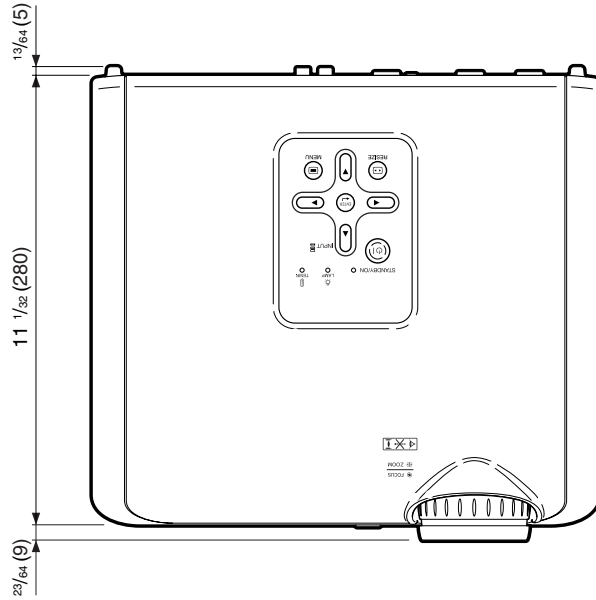

Index

| | | | |
|------------------------------------|------------|---|--------|
| AC socket | 28 | Lamp | 10, 56 |
| Accessories | 10 | Lamp indicator | 54 |
| Adjustment buttons | 41 | Lamp Setting | 45 |
| Aspect ratio | 36 | Lamp Timer (Life) | 49 |
| Auto Power Off | 49 | Lamp unit | 57 |
| Auto Sync | | Language (on-screen display language) | 50 |
| (Auto Sync adjustment) | 46 | Lens cap | 11 |
| AUTO SYNC button | 46 | | |
| | | MENU button | 41 |
| Background | 48 | ON button | 28 |
| Backlight button | 13 | Optional accessories | 10 |
| Blue | 43 | OSD Display | 48 |
| Bright | 43 | Overscan | 47 |
| BrilliantColor™ | 43 | | |
| | | Phase | 46 |
| Checking the Input Signal | 46 | Picture Adjustment | 43 |
| CINEMA ZOOM | 36, 37 | Picture Mode | 38, 43 |
| Clock | 46 | PICTURE MODE button | 38 |
| CLR Temp (Color Temperature) | 44 | Picture (Screen) Size and Projection Distance | 20 |
| C.M.S. | 44 | Power cord | 28 |
| Color | 43 | PRJ Mode | 19, 49 |
| Contrast | 43 | Progressive | 44 |
| | | | |
| DOT BY DOT | 37 | R-03 batteries | 14 |
| DNR | 45 | Rear adjustment foot | 31 |
| Dust filters | 52 | Red | 43 |
| | | Remote control | 13 |
| ENTER button | 41 | Remote control sensor | 15 |
| Exhaust vent | 12, 51 | Replacing the lamp | 56, 57 |
| | | Resize | 36, 37 |
| Fan Mode | 50 | RESIZE button | 36 |
| Fine Sync | 46 | RETURN button | 41 |
| Focus ring | 30 | RGB/COMP. button | 48 |
| FREEZE button | 38 | RS-232C Setting | 50 |
| | | RS-232C terminal | 27 |
| GEOMETRIC ADJUSTMENT | 34 | | |
| | | Saturation | 44 |
| H & V KEYSTONE | 35 | Sharp | 43 |
| HDMI Setting | 48 | SIDE BAR | 36, 37 |
| H-Pos | 46 | Special Modes | 46 |
| HEIGHT ADJUST lever | 30 | STANDBY button | 29 |
| Hue | 44 | STANDBY/ON button | 28, 29 |
| | | STANDBY Mode | 50 |
| INPUT 1 terminal | 23 | STRETCH | 36, 37 |
| INPUT 1 – 6 modes | 29 | Subtitle | 47 |
| INPUT 2 terminal | 23 | Supplied accessories | 10 |
| INPUT 3 terminal | 24 | | |
| INPUT 4 terminal | 24 | Temperature warning indicator | 54 |
| INPUT 5 terminal | 25, 26 | Tint | 43 |
| INPUT 6 terminal | 25 | TRIGGER terminal | 12 |
| INPUT buttons | 29 | | |
| Intake vent | 11, 12, 51 | Value | 44 |
| IRIS button | 38 | Video System | 48 |
| | | V-Pos | 46 |
| Kensington Security | | | |
| Standard connector | 12, 13 | Zoom ring | 30 |
| KEYSTONE button | 32 | | |
| Keystone Correction | 32 | | |

