



**PowerLite® Pro**

**Z8150NL/Z8250NL/Z8255NL/**

**Z8350WNL/Z8450WUNL/Z8455WUNL**

**User's Guide**

## Notations Used in This Guide





- **Safety indications**

The documentation and the projector use graphical symbols to show how to use the projector safely.

Please understand and respect these caution symbols in order to avoid injury to persons or property.

<b>Warning</b>	Indicates information that, if ignored, could possibly result in personal injury or even death due to incorrect handling.
<b>Caution</b>	Indicates information that, if ignored, could possibly result in personal injury or physical damage due to incorrect handling.

- **General information indications**

<b>Caution</b>	Indicates procedures which may result in damage or injury if sufficient care is not taken.
	Indicates additional information and points which may be useful to know regarding a topic.
	Indicates a page where detailed information regarding a topic can be found.
	Indicates that an explanation of the underlined word or words in front of this symbol appears in the glossary of terms. See the "Glossary" section of the "Appendix".  <a href="#">p.208</a>
<b>Procedure</b>	Indicates operating methods and the order of operations. The procedure indicated should be carried out in the order of the numbered steps.
[ (Name) ]	Indicates the name of the buttons on the remote control or the control panel. Example: [ESC] button
"(Menu Name)" <b>Brightness</b> (Boldface)	Indicates the configuration menu items. Example: <b>Select "Brightness" from the Image menu.</b> <b>Image</b> menu - <b>Brightness</b>

- **Screen shots of the configuration menu**

The screen shots may be different from those shown in this manual depending on your projector model.

## Introduction

<b>Projector Features</b> .....	<b>9</b>
Ease of Use when Installed on a Ceiling Mount .....	9
Reliability You can Depend on .....	10
Meets a Wide Range of Needs .....	11
Enhanced Security Functions .....	12
Easy to Handle .....	12
Monitoring and Control Functions .....	12
Taking Full Advantage of a Network Connection .....	12
<b>Part Names and Functions</b> .....	<b>14</b>
Front/Top .....	14
Rear .....	15
Interface .....	16
Control Panel .....	18
Remote Control .....	19
Unpacking the projector .....	21
Installing the batteries .....	22
Operating range of remote control .....	23

## Useful Functions

<b>Changing the Projected Image</b> .....	<b>25</b>
Automatically Detect Input Signal and Change the Projected Image (Source Search) .....	25
Switch to the Target Image using the Remote Control .....	26
<b>Changing the Aspect Ratio of the Projected Image</b> .....	<b>27</b>

Changing the Aspect Mode (PowerLite Pro Z8450WUNL/Z8455WUNL) .....	28
Projecting images from video equipment or from the HDMI1/2 or SDI input port .....	28
Projecting images from a computer .....	29
Changing the Aspect Mode (PowerLite Pro Z8350WNL) .....	30
Projecting images from video equipment or from the HDMI1/2 input port .....	30
Projecting images from a computer .....	30
Changing the Aspect Mode (PowerLite Pro Z8150NL/Z8250NL/Z8255NL) .....	31
Projecting images from video equipment .....	31
Projecting images from the HDMI1/2 input port .....	32
Projecting images from a computer .....	32

## Selecting the Projection Quality (Selecting Color Mode) .....

## Projecting Two Images Simultaneously (Split Screen) .....

Input Sources for Split Screen Projection .....	35
Operating Procedures .....	36
Projecting on a split screen .....	36
Switching the left and right screens .....	37
Switching the left and right image sizes .....	37
Ending the split screen .....	38
Restrictions during Split Screen Projection .....	38
Operating restrictions .....	38
Restrictions relating to images .....	38

## Functions for Enhancing Projection .....

Hiding the Image Temporarily (Shutter) .....	39
Freezing the Image (Freeze) .....	39
Pointer Function (Pointer) .....	40
Enlarging Part of the Image (E-Zoom) .....	41

- Saving a User's Logo ..... 43**
- Security Functions ..... 45**
  - Managing Users (Password Protect) ..... 45
    - Type of Password Protect ..... 45
    - Setting Password Protect..... 45
    - Entering the Password ..... 46
  - Restricting Button Operation ..... 47
    - Control Panel Lock..... 47
    - Lens Operation Lock ..... 48
    - Remote control button lock ..... 49
  - Theft-Deterrent Lock ..... 50
    - Installing the wire lock ..... 50
- Memory Function ..... 51**
  - Available Settings ..... 51
  - Saving/Loading/Erasing the Memory ..... 51
    - Saving to memory ..... 51
    - Loading a saved memory ..... 52
    - Erasing a saved memory ..... 52
    - Renaming a saved memory ..... 52

## Configuration Menu

---

- Using the Configuration Menu ..... 55**
  - Configuration Menu..... 56
  - Network Menu..... 58
- Image Menu ..... 60**
- Signal Menu ..... 62**
- Settings Menu ..... 65**

- Extended Menu ..... 67**
- Network Menu ..... 70**
  - Notes on Operating the Network Menu ..... 71
  - Soft Keyboard Operations ..... 72
  - Basic Menu..... 73
  - Wireless LAN Menu..... 74
    - Search Access Point screen..... 76
  - Security Menu (Only Available when the Optional Wireless LAN Unit Is Installed)..... 77
    - When WPA/WPA2-PSK is selected ..... 78
    - When WPA/WPA2-EAP is selected ..... 79
  - Wired LAN Menu ..... 81
  - Administrator Settings Menu ..... 82
    - Mail Notification menu..... 84
    - Manage Certificates menu ..... 85
    - SNMP menu ..... 87
  - Reset Menu ..... 88
- Info Menu (Display Only) ..... 89**
- Reset Menu ..... 91**

## Troubleshooting

---

- Using the Help ..... 93**
- Problem Solving ..... 95**
  - Reading the Indicators ..... 96
    - ⏻ Indicator is lit or flashing red..... 97
    - 🔦 📶 Indicator is flashing or lit ..... 99

- When the Indicators Provide No Help ..... 101
  - Problems relating to images.....103
  - Problems when projection starts .....107
  - Other problems.....109
  - Interpreting Event IDs.....112

**Where to Get Help ..... 114**

- Internet Support ..... 114
- Speak to a Support Representative.....114
- Purchase Supplies and Accessories.....114

**Maintenance**

---

**Cleaning ..... 116**

- Cleaning the Projector's Surface ..... 116
- Cleaning the Lens .....116
- Cleaning the Air Filter ..... 116

**Replacing Consumables ..... 119**

- Replacing the Lamps ..... 119
  - Lamp replacement period.....119
  - How to replace the lamp .....119
  - Resetting the Lamp Hours.....121
- Replacing the Air Filter ..... 122
  - Air filter replacement period .....122
  - How to replace the air filter .....122

**Notes on Transportation ..... 124**

- Moving Nearby.....124
- When Transporting.....124
  - Preparing packaging.....124
  - Notes when packing and transporting.....124

- Image Maintenance ..... 125**
  - Panel Alignment ..... 125

**Monitoring and Controls**

---

**EasyMP Monitor..... 128**

**Changing Settings Using a Web Browser (Web Control) ..... 129**

- Displaying Web Control ..... 129
- Displaying Web Remote ..... 129
- Displaying Lens Control ..... 130
- Setting Certificates ..... 131
- Secure HTTP Notes ..... 132

**Using the Mail Notification Function to Report Problems ..... 133**

- Reading Problem Mail Notification Function ..... 133

**Management Using SNMP ..... 134**

**ESC/VP21 Commands..... 135**

- Serial Connection ..... 135
- Communications Protocol..... 135
- Command List ..... 135

**About PJLink ..... 137**

**About Crestron RoomView®..... 138**

- Operating a Projector from a Computer Window ..... 138
  - Displaying the operation window ..... 138
  - Using the operation window ..... 139
  - Using the tools window..... 141

**About Message Broadcasting ..... 143**

## Network Functions

---

**Projecting with "Connect to a Network Projector" ..... 145**

**Making a WPS (Wi-Fi Protected Setup) Connection with a Wireless LAN Access Point. .... 146**

- Connection Setup Method ..... 146
  - Making a connection using the push button method ..... 147
  - Making a connection using the PIN Code Method ..... 148

## Installation and Connections

---

**Installation Methods ..... 152**

**Connecting to Equipment ..... 154**

- Connecting to a Computer ..... 154
  - Changing the video output from a laptop computer..... 155
- Connecting to Video Equipment..... 156

**Adjusting the Projected Image..... 159**

- Displaying a Test Pattern ..... 159
- Adjusting the Position of the Projected Image (Lens Shift) ..... 161
- Focusing the Image ..... 162
- Zooming the Image ..... 162
- Adjusting the Tilt of the Projected Image..... 163
- Correcting Distortion in the Projected Image..... 163
  - Quick Corner ..... 164
  - H/V-Keystone..... 166
  - Arc Correction ..... 168

**Adjusting the Image Quality ..... 171**

- Hue, Saturation, and Brightness Adjustment ..... 171

- Gamma Adjustment..... 171
  - Select and adjust the correction value ..... 171
  - Adjust while viewing the image ..... 172
  - Adjust using the gamma adjustment graph..... 172
- Frame Interpolation  
(PowerLite Pro Z8450WUNL/Z8455WUNL only)..... 173
- Super-resolution ..... 173
- Noise Reduction..... 173
  - Noise Reduction ..... 173
  - Mosquito NR..... 174

**Settings for Multiple Projectors ..... 175**

- Preparation Flow..... 175
- Requirements ..... 175
- Projector ID/Remote Control ID..... 175
  - Setting the projector ID ..... 176
  - Checking the Projector ID ..... 176
  - Setting the remote control ID ..... 177
- Adjusting the Position of the Projected Image..... 178
  - Point Correction ..... 178
- Checking the Color Mode..... 180
- Using the Edge Blending Function ..... 180
- Adjusting to Match Colors on Multi-Projection ..... 182
- Displays the Image Partly Enlarged (Scale) ..... 183

**Setting Schedule ..... 185**

- Setting Methods ..... 185
- Clock ..... 186
  - Daylight Saving Time screen ..... 186
- Schedule..... 186
  - Clock / Schedule Setting screen ..... 186

**Connecting to External Equipment ..... 187**

- Connecting a LAN Cable..... 187
- Connecting to an External Monitor..... 187
- Installing Optional and Supplied Accessories ..... 188**
- Removing and Attaching the Projector Lens Unit..... 188
  - Removing ..... 188
  - Attaching..... 189
- Installing the Wireless LAN Unit (V12H418P12) ..... 192
  - Attaching..... 192
  - Reading the wireless LAN indicators ..... 192
- Attaching and Removing the Interface Cover..... 193
  - Removing ..... 193
  - Attaching..... 194
- Removing the Feet ..... 195

## Appendix

---

- Optional Accessories and Consumables ..... 197**
- Optional Accessories ..... 197
- Consumables ..... 197
- Screen Size and Projection Distance ..... 198**
- Supported Monitor Displays ..... 200**
- Supported Monitor Displays ..... 200
  - Computer signals (analog RGB)..... 200
  - Component Video ..... 200
  - Composite Video/S-Video..... 200
  - Input signals from HDMI1/2 input port ..... 201
  - Input signals from SDI input port  
(PowerLite Pro Z8450WUNL/Z8455WUNL only) ..... 201

- Supported Certificates.....202**
- Client Certificate (PEAP-TLS/EAP-TLS)..... 202
- Server Certificate (PEAP/PEAP-TLS/EAP-TLS/EAP-Fast)..... 202
- Web Server Certificate (Secure HTTP) ..... 202
- Specifications.....203**
- Projector General Specifications ..... 203
- Appearance.....207**
- Glossary .....208**
- General Notes.....211**
- About Notations ..... 211
- Recycling ..... 211
- Important Safety Instructions..... 211
  - Restriction of Use ..... 215
- FCC Compliance Statement..... 215
  - For United States Users ..... 215
  - For Canadian Users ..... 216
- Wireless Telegraphy Act Regulations ..... 216
- Software Copyright ..... 216
- Trademarks ..... 255
- Copyright Notice..... 255
  - A Note Concerning Responsible Use of Copyrighted Materials..... 256
  - Copyright Attribution..... 256

# Introduction

This chapter explains the projector's features and the part names.



## Projector Features

### Ease of Use when Installed on a Ceiling Mount

#### Centered lens

The lens is positioned in the center of the projector so it is well balanced and is easy to mount on a ceiling. This also makes it easy to line up the screen and the projector.

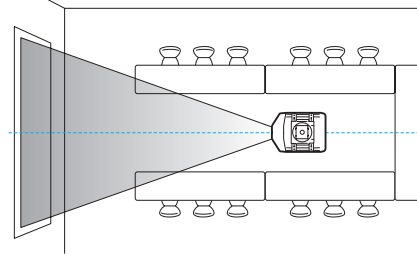

#### Equipped with electric lens shift, zoom and focus functions

The lens shift function allows you to adjust the position of the projected image along the horizontal and vertical axes which opens up a wide variety of installation locations. [p.161](#)

The lens shift, zoom, and focus functions can be operated with a remote control so operation is easy even if the projector is mounted on the ceiling.

#### Variety of optional lenses available

You can select the best lens according to the projection distance and purpose. The bayonet type lenses allow you to simply and easily exchange and install the optional lenses. [p.188, p.197](#)

### Various angles of projection

The projector can be pointed up, down, or angled to project images on the ceiling or floor, in addition to normal horizontal projection. This makes it an effective communication tool that lets you express your ideas with great impact. [p.152](#)

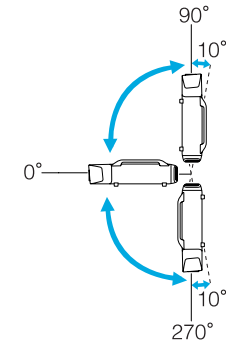

### A design that harmonizes with the surrounding environment, and makes the installation easy

The projector's sophisticated design has a cable cover in which cables are hidden for a clean exterior appearance.

The bar type handles are designed to make moving and installing the projector easy so it can be handled safely. The ceiling mount is attached to these handles when you mount the projector on the ceiling. The projector does not need to be turned upside down so installation is easy. The initial settings can be easily set as you look at the screen because the control panel is located on the back of the projector.

### Easy maintenance

You can replace the lamp by opening a cover and pulling it straight out of the back of the projector without using a screwdriver.

There is only one air filter so cleaning and replacement are easy. The lamp and air filter can be safely replaced even when mounted on the ceiling because their covers do not fall off even if you release them.

---

## Reliability You can Depend on

### **Dual lamps to reduce risk of shutdown**

The projector is equipped with two lamps. Even if one of the lamps breaks, you can continue projecting with the other lamp and avoid disrupting important presentations.

### **Operating temperature of 32–122°F (0–50°C)**

Special coolant and fan in cooling system work against a high temperature environment during operation and improve reliability in normal use.

Depending on projector settings and environmental conditions, you can use this projector in a place up to 122°F (50°C).

## Meets a Wide Range of Needs

### Equipped with a high-resolution WUXGA panel (PowerLite Pro Z8450WUNL/Z8455WUNL only)

You can project a large amount of information on the screen. Viewers can see the information at a glance without having to scroll or switch screens.

The frame interpolation feature helps reduce motion blur or jumpiness in fast moving video, such as sports and action movies, so that it plays more smoothly.

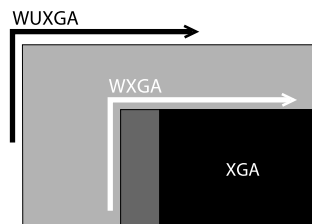

### Project two images simultaneously (Split Screen)

You can simultaneously project the images from two video sources next to each other. For example, you can hold a video conference while projecting presentation materials.

☞ p.35



## Clearly reproduce medical images

"DICOM SIM" is a color mode used to project medical images such as X-ray photographs. This mode produces image quality that approaches the DICOM standard.

(The projector is not a medical device and cannot be used for medical diagnosis.) ☞ p.34

## Epson Cinema Filter supports the color gamut for digital cinema.

Select Theatre or sRGB in Color Mode to use Epson Cinema Filter. When color mode is set to Theatre, 100% reproduction of the color gamut used for digital cinema is possible. As a result, this reproduces colors that are full and deep.

## Precise color adjustments

As well as Color Mode, you can adjust the image's absolute color temperature and the strength of each RGB color. Also, you can adjust the hue, saturation, and brightness of R,G,B,C,M, and Y.

The image settings can be saved in memory and recalled when needed. If you use the projector in several places, you can easily use the previous settings again.

## Seamlessly project multiple images together

When projecting on one screen from multiple projectors, color tone differences between each projected image can be adjusted, using Multi-screen and Edge Blending, to create a seamless screen. ☞ p.175

---

## Enhanced Security Functions

### Password Protect to restrict and manage users

By setting a password you can restrict who can use the projector.  [p.45](#)

### Control Panel Lock restricts button operation on the control panel

You can use this to prevent people changing projector settings without permission at events, in schools, and so on.  [p.47](#)

### Equipped with various theft-deterrent devices

The projector is equipped with the following types of theft-deterrent security devices.  [p.50](#)

- Security slot
- Security cable installation point

---

## Easy to Handle

### Direct power On/Off

In places where power is managed centrally, such as in a conference room, the projector can be set to power on and off automatically when the power source to which the projector is connected is switched on or off.

### No cool down delay

After turning the projector's power off, you can disconnect the projector's power cable without having to wait for the projector to cool down.

---

## Monitoring and Control Functions

### Schedule

You can schedule events to turn the projector power on/off and switch the input source. Registered events are executed automatically at the specified time and date every week.  "Setting Schedule" [p.185](#)

### Various monitoring and control options

A variety of monitoring and control options are supported, such as the Epson EasyMP Monitor software. This software allows you to use the projector according to your system environment.  "Monitoring and Controls" [p.127](#)

---

## Taking Full Advantage of a Network Connection

### Simultaneously project four images for dynamic conferences

By using the included EasyMP Multi PC Projection software, you can select up to 4 images from up to 32 computers that are connected to the network, and divide the projector's screen to show them together. Anyone can freely and easily project images from connected computers to make conferences and meetings more lively. See your *EasyMP Multi PC Projection Operation Guide* for more information.

### Transferring images over the network

The included EasyMP Network Projection software can be used to connect to network computers and transfer video and movies. A variety of transfer functions are available to increase presentation possibilities. See your *EasyMP Multi PC Projection Operation Guide* for more information.

\* This unit cannot transfer audio.

## **Project using "Connect to a Network Projector"**

By connecting the projector to a network and using the Network Projector function in Windows Vista or Windows 7, multiple users on the network can share the projector. 🖱️ [p.145](#)

## Part Names and Functions

### Front/Top

The illustration shows the projector with a standard zoom lens installed.

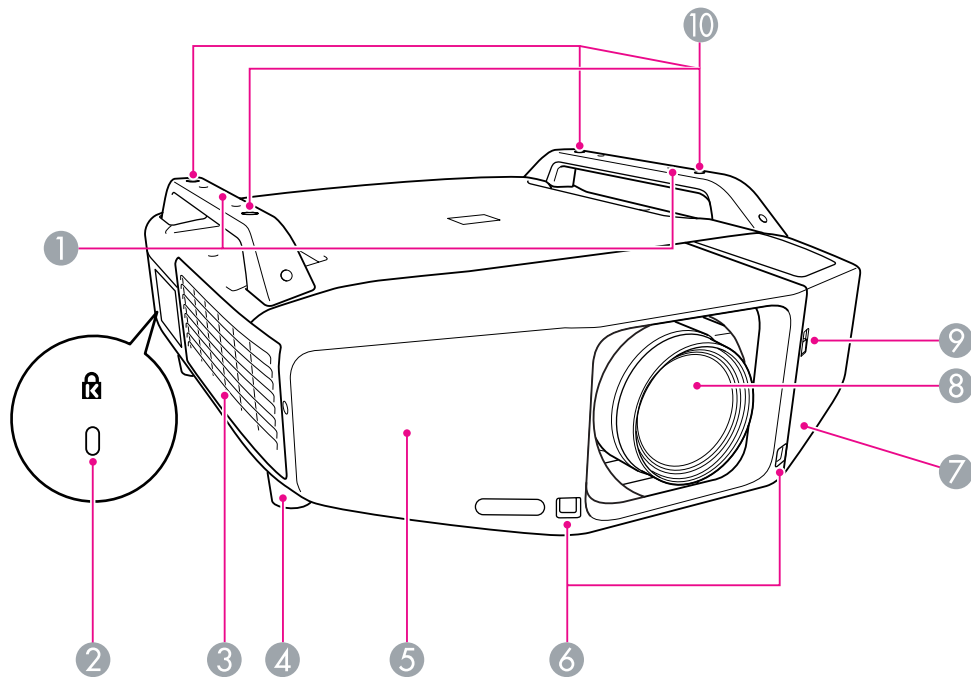

Name	Function
<b>1 Handle</b>	Use these handles when carrying the projector. Also, you can pass a theft-deterrent wire lock through the handles to secure the projector. <a href="#">☛ p.50</a> <b>Caution</b> Do not carry the projector by yourself. Two people are needed to unpack or carry the projector.
<b>2 Security slot(🔒)</b>	The security slot is compatible with the Microsaver Security System manufactured by Kensington. <a href="#">☛ p.50</a>
<b>3 Air intake vent (Air filter)</b>	Takes in air to cool the projector internally. If dust collects here it can cause the internal temperature to rise, and this can lead to problems with operation and shorten the optical engine's service life. Be sure to clean the air filter regularly. <a href="#">☛ p.116, p.122</a>
<b>4 Front adjustable foot</b>	When set up on a desk, turn to extend and retract to adjust the horizontal tilt. The front adjustable feet can be removed when the projector is installed on a ceiling. <a href="#">☛ p.195</a>
<b>5 Front cover</b>	Remove this cover to remove or install the lens unit when replacing the lens. <a href="#">☛ p.188</a> This cover must be installed when using the projector.
<b>6 Remote receiver</b>	Receives signals from the remote control. <a href="#">☛ p.23</a>
<b>7 Interface cover</b>	Remove this cover to connect cables to the ports inside when connecting the projector to video equipment. <a href="#">☛ p.16, p.193</a>
<b>8 Projection lens</b>	Images are projected through here.

Name		Function
9	<b>Interface cover open/close switch</b>	Opens and closes the interface cover. <a href="#">p.193</a>
10	<b>Ceiling mount attachment points (Four points)</b>	Attach the optional ceiling mount here when suspending the projector from a ceiling. <a href="#">p.152</a> , <a href="#">p.197</a>

## Rear

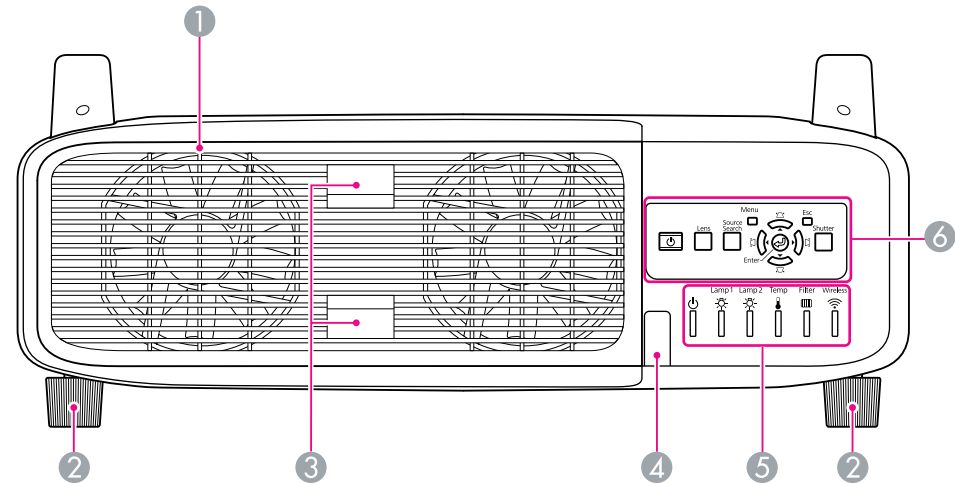

Name		Function
1	<b>Air exhaust vent (Lamp cover)</b>	Exhaust vent for air used to cool the projector internally. Also, open this cover to replace the projector's lamps. <b>Caution</b> <i>Do not place objects that may become warped or otherwise affected by heat near the air exhaust vent and do not put your face or hands near the vent while projection is in progress.</i>
2	<b>Rear foot</b>	When set up on a desk, turn to extend and retract to adjust the horizontal tilt. The rear adjustable feet can be removed when the projector is installed on a ceiling. <a href="#">p.194</a>
3	<b>Lamp cover open tab</b>	Use these tabs to open the lamp cover. <a href="#">p.119</a>

Name	Function
<b>4 Remote receiver</b>	Receives signals from the remote control. <a href="#">p.23</a>
<b>5 Status indicators</b>	The color of the indicators and whether they are flashing or lit indicate the status of the projector. <a href="#">p.96</a>
<b>6 Control panel</b>	"Control Panel" <a href="#">p.18</a>



## Interface

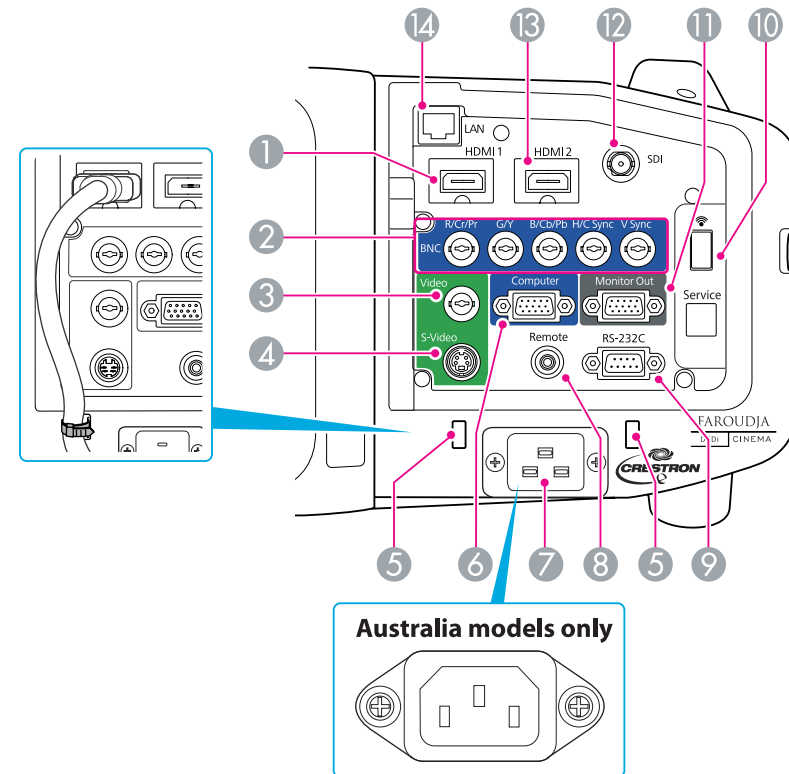

The following ports can be accessed by removing the interface cover. For information on how to remove the interface cover and connect video equipment, "Attaching and Removing the Interface Cover" [p.193](#), "Connecting to Equipment" [p.154](#)



Name	Function
<b>1 HDMI1 input port</b>	For video signals from HDMI compatible video equipment and computers. This projector is compatible with <b>HDCP</b> signals.



Name		Function
2	<b>BNC input port</b>	For analog RGB signals from a computer and component video signals from other video sources.
3	<b>Video input port</b>	For composite video signals from video sources.
4	<b>S-Video input port</b>	For S-Video signals from video sources.
5	<b>Cable holder</b>	When a thick heavy HDMI cable is connected to the HDMI input port, run a commercially available cable tie through this holder to prevent the cable from disconnecting.
6	<b>Computer input port</b>	For analog RGB signals from a computer and component video signals from other video sources.
7	<b>Power inlet</b>	Connects to the power cable. The shape may differ depending on your projector model.
8	<b>Remote port</b>	Connects the optional remote control cable set and inputs signals from the remote control. When the remote control cable is plugged into this port, the remote receiver on the projector is disabled.
9	<b>RS-232C port</b>	When controlling the projector from a computer or controller, connect it with an RS-232C cable. This port is for control use and should not normally be used.  p.135
10	<b>Wireless LAN unit port</b>	Connects to the optional wireless LAN unit.  p.192

Name		Function
11	<b>Monitor Out port</b>	Outputs to an external monitor the analog signal from the computer connected to the Computer input port or the BNC input port. This is not available for component video signals or other signals being input to any port other than the Computer input port or the BNC input port.  p.187
12	<b>SDI port (PowerLite Pro Z8450WUNL/ Z8455WUNL only)</b>	For SDI signals from a video equipment.
13	<b>HDMI2 input port</b>	For video signals from HDMI compatible video equipment and computers. This projector is compatible with <u>HDCP</u>  signals.
14	<b>LAN port</b>	Connects a LAN cable to connect to a network.  p.187

## Control Panel

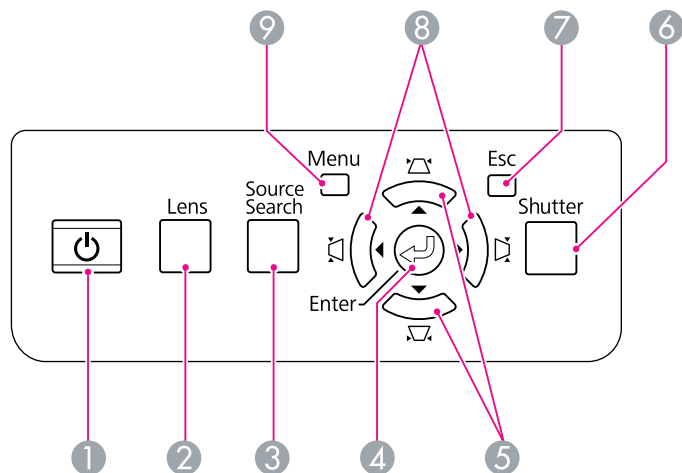

	Name	Function
1	[ <b>Power</b> ] button	Turns the projector power On or Off.
2	[ <b>Lens</b> ] button	Press this button to cycle through the focus, zoom, and lens shift settings to adjust the lens.
3	[ <b>Source Search</b> ] button	Changes to the next input source that is connected to the projector and is sending an image. <a href="#">p.25</a>
4	[ <b>Enter</b> ] button	If pressed during projection of computer analog RGB signals, it automatically adjusts the Tracking, Sync., and Position to project the optimum image. When the configuration menu or a Help screen is displayed, it accepts and enters the current selection and moves to the next level. <a href="#">p.55</a>

	Name	Function
5	[ <b>Keystone</b> ] button	Corrects vertical keystone distortion. <a href="#">p.166</a> If pressed while the configuration menu or a Help screen is displayed, these buttons only have the [ <b>Up</b> ] and [ <b>Down</b> ] functions which select menu items and setting values. <a href="#">p.55</a> When projecting using "Connect to a Network Projector", these buttons function only as [ <b>Up</b> ] and [ <b>Down</b> ] buttons.
6	[ <b>Shutter</b> ] button	Closes or opens the electric shutter, or mutes the image temporarily to dim the screen. Any operation that is selected after using the [Shutter] button, is still executed. <a href="#">p.39</a>
7	[ <b>Esc</b> ] button	Stops the current function. If pressed when the configuration menu is displayed, it moves to the previous menu level. <a href="#">p.55</a>
8	[ <b>Keystone</b> ] button	Corrects horizontal keystone distortion. <a href="#">p.166</a> If pressed while the configuration menu or a Help screen is displayed, these buttons only have the [ <b>Left</b> ] and [ <b>Right</b> ] functions which select menu items and setting values. <a href="#">p.55</a> When projecting using "Connect to a Network Projector", these buttons function only as [ <b>Left</b> ] and [ <b>Right</b> ] buttons.
9	[ <b>Menu</b> ] button	Displays and closes the configuration menu. <a href="#">p.55</a>

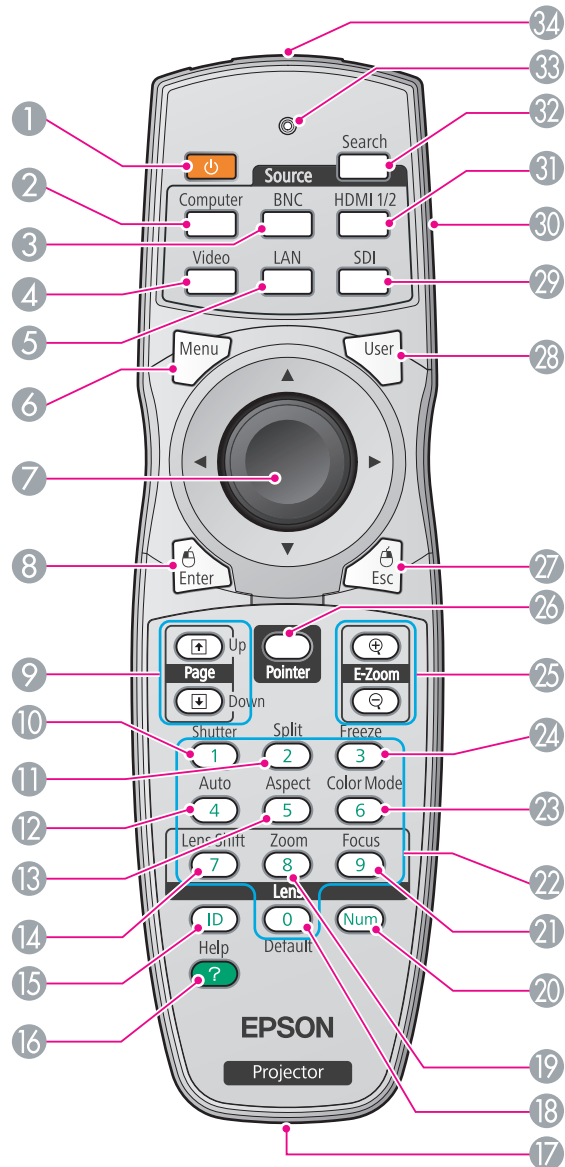

## Remote Control



	Name	Function
1	[Power] button	Turns the projector power on or off.
2	[Computer] button	Changes to images from the Computer input port.  p.26
3	[BNC] button	Changes to images from the BNC input port.  p.26
4	[Video] button	Each time the button is pressed, the image displayed changes between the Video input port and S-Video input port.  p.26
5	[LAN] button	Changes to images from network sources.  p.26
6	[Menu] button	Displays and closes the configuration menu.  p.55
7	[Directional] button	When the configuration menu or Help screen is displayed, it selects menu items and setting values.  p.55, p.93 When using the optional wireless mouse receiver, use this button to move the pointer in the desired direction.
8	[Enter] button	When the configuration menu or a Help screen is displayed, it accepts and enters the current selection and moves to the next level.  p.55, p.93 Acts as a mouse's left button when using the optional wireless mouse receiver.
9	[Page] buttons [Up][Down]	When using the optional wireless mouse receiver, you can change the PowerPoint file page during projection by pressing the page up/page down buttons.

Name		Function
10	<b>[Shutter] button</b>	Closes or opens the electric shutter, or mutes the image temporarily to blank the screen. Any operation that is selected after using the [Shutter] button, is still is executed. 🖱️ p.39
11	<b>[Split] button</b>	Press this button to split the screen in two and project two images simultaneously. 🖱️ p.35
12	<b>[Auto] button</b>	If pressed during projection of computer analog RGB signals, it automatically adjusts the Tracking, Sync., and Position to project the optimum image.
13	<b>[Aspect] button</b>	The <u>Aspect Ratio</u> changes each time the button is pressed. 🖱️ p.27
14	<b>[Lens Shift] button</b>	Press to adjust the lens shift. 🖱️ p.161
15	<b>[ID] button</b>	Press to set the remote control ID. 🖱️ p.175
16	<b>[Help] button</b>	Displays and closes the Help screen which shows you how to deal with problems if they occur. 🖱️ p.93
17	<b>Remote port</b>	Connects the optional remote control cable set and outputs signals from the remote control. When the remote control cable is plugged into this remote port, the remote receiver is disabled.
18	<b>[Default] button</b>	Reset to default the setting values being adjusted in some configuration menus.
19	<b>[Zoom] button</b>	Press to adjust the zoom. 🖱️ p.162
20	<b>[Num] button</b>	Use this button to enter passwords, IP Address from the Network, and so on. 🖱️ p.45
21	<b>[Focus] button</b>	Press to adjust the focus. We recommend setting the focus, zoom, and lens shift at least 30 minutes after you start the projection, because images are not stable right after turning on the projector. 🖱️ p.162

Name		Function
22	<b>Numeric buttons</b>	Use this button to enter passwords, remote control ID settings, IP Address from the Network, and so on. 🖱️ p.177, p.45
23	<b>[Color Mode] button</b>	Each time the button is pressed, the Color Mode changes. 🖱️ p.34
24	<b>[Freeze] button</b>	Images are paused or unpaused. 🖱️ p.39
25	<b>[E-Zoom] buttons [⊕][⊖]</b>	The [⊕] button enlarges the image without changing the projection size. The [⊖] button reduces the parts of images that have been enlarged using the [⊕] button. 🖱️ p.41
26	<b>[Pointer] button</b>	Press to activate the on screen pointer. 🖱️ p.40
27	<b>[Esc] button</b>	Stops the current function. If pressed when the configuration menu is displayed, it moves to the previous menu level. 🖱️ p.55 Acts as a mouse's right button when using the optional wireless mouse receiver.
28	<b>[User] button</b>	Press to assign a frequently used item from the available configuration menu items. By pressing the button the assigned menu item selection/adjustment screen is displayed, allowing you to make one-touch settings/adjustments. 🖱️ p.65 <b>Test Pattern</b> is assigned as the default setting.
29	<b>[SDI] button</b>	Changes to images from the SDI input port. 🖱️ p.26 This button does not function when using PowerLite Pro Z8150NL/Z8250NL/Z8255NL/Z8350WNL.
30	<b>[ID] switch</b>	Use this switch to enable (On)/disable (Off) ID settings for the remote control. 🖱️ p.175

	Name	Function
31	<b>[HDMI 1/2] button</b>	Each time the button is pressed, the image displayed changes between the HDMI1 input port and HDMI2 input port.  <a href="#">p.26</a>
32	<b>[Search] button</b>	Changes to the next input source that is connected to the projector and is sending an image.  <a href="#">p.25</a>
33	<b>Indicators</b>	A light is emitted when outputting remote control signals.
34	<b>Remote control light-emitting area</b>	Outputs remote control signals.

## Unpacking the projector

After unpacking the projector, make sure you have all the parts shown below:

Save all packaging in case you need to ship the projector. Always use the original packaging (or the equivalent) when you need to send the projector to another location. Before you move the projector, see the moving and transportation instructions.

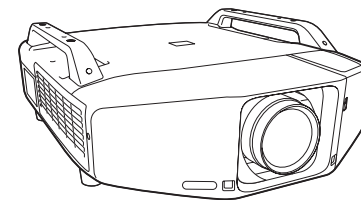

Projector (lens not included)

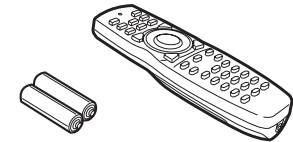

Remote control and 2 AA batteries

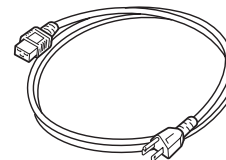

Power cord

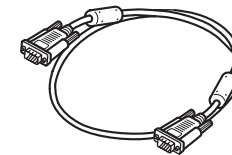

VGA cable



foot covers

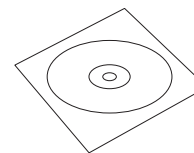

PDF manuals and registration CD

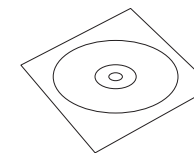

Projector software CD



Password Protected sticker

## Installing the batteries

The remote control uses the two AA batteries that came with the projector.

### Caution

Make sure you read the Safety Instructions before handling the batteries.  p.211

### Procedure

- 1 Remove the battery cover.**

While pushing the battery compartment cover catch, lift the cover up.

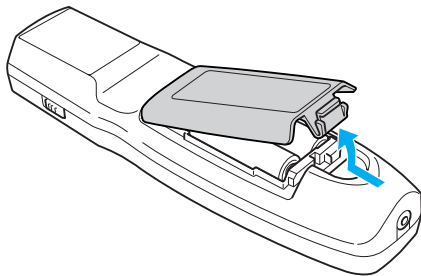

- 2 Insert the batteries in the correct direction.**

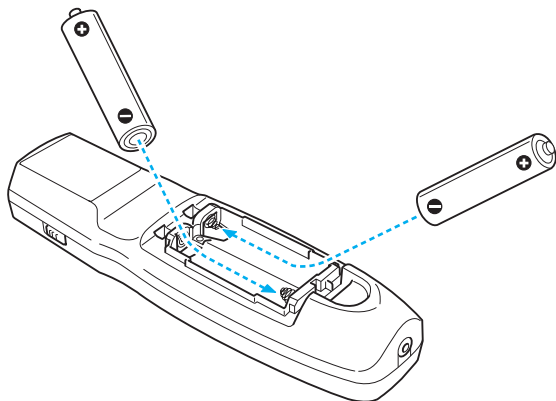

### Warning

Check the positions of the (+) and (-) marks inside the battery holder to ensure the batteries are inserted the correct way.

- 3 Replace the battery cover.**

Press until it clicks into place.

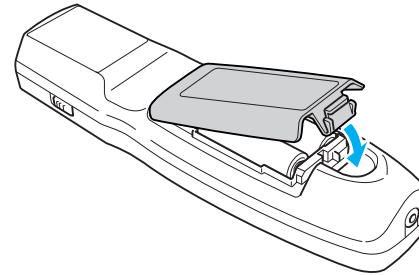

If delays in the responsiveness of the remote control occur or if it does not operate after it has been used for some time, it probably means that the batteries are becoming flat. When this happens, replace them with new batteries. Have two AA size alkaline batteries ready. Do not use other batteries except for AA size alkaline batteries.

## Operating range of remote control

When using the remote control, point the remote control light-emitting area at the remote receiver on the projector. The operating range of the remote control that is provided with the projector is shown below.

### Horizontal operating range

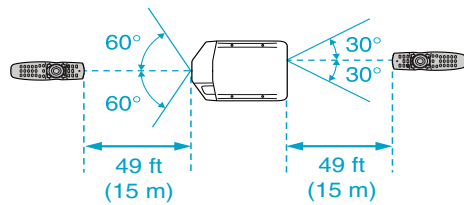

### Vertical operating range

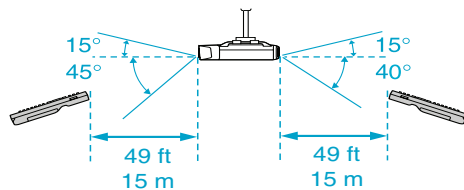

- To restrict reception of the operation signals from the remote control, set the **Remote Receiver** on the **Settings** menu. [p.65](#)
- When using a remote control provided with other Epson projectors, set the **Remote Control Type** on the **Extended** menu. [p.67](#)  
The operating range will depend on the remote control that you use.

# Useful Functions

This chapter explains useful tips for giving presentations, and the security functions.



## Changing the Projected Image

You can change the projected image in the following two ways.

- Changing by Source Search

The projector automatically detects signals being input from connected equipment, and the image being input from the input port is projected.

- Changing directly to the target image

You can use the remote control buttons to change to the target input port.

## Automatically Detect Input Signal and Change the Projected Image (Source Search)

You can project the target images quickly by pressing the [Search] or [Source Search] button because it will switch only to images from input ports to which image signals are being input.

### Procedure

**When your video equipment is connected, start playback before beginning this operation. When two or more pieces of equipment are connected, press the [Search] or [Source Search] button until the target image is projected.**

#### Using the Remote Control

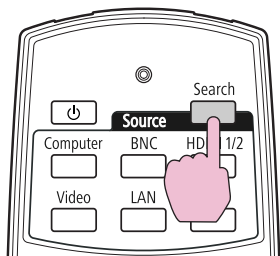

#### Using the Control Panel

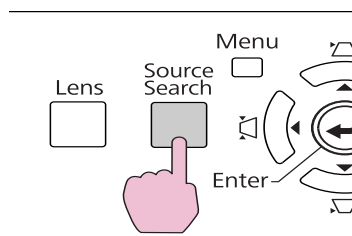

When the [Search] or [Source Search] button is pressed, a search is made for input ports to which video signals are being input in the following order. (Input ports where no image signal is being input are skipped.)

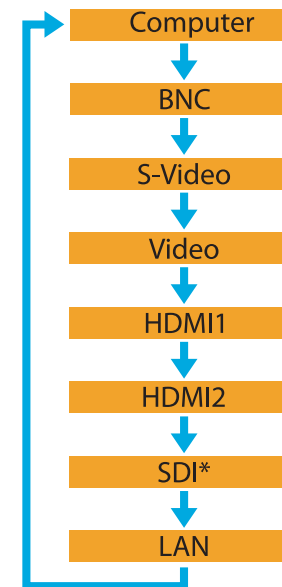

\* PowerLite Pro Z8450WUNL/Z8455WUNL only

When switching to LAN, images from computers connected through the network are projected.



The following screen showing the status of image signals remains displayed when only the image that the projector is currently displaying is available, or when no image signal can be found. You can select the input port where the equipment you want to use is connected. If no operation is performed after about 10 seconds, the screen closes.

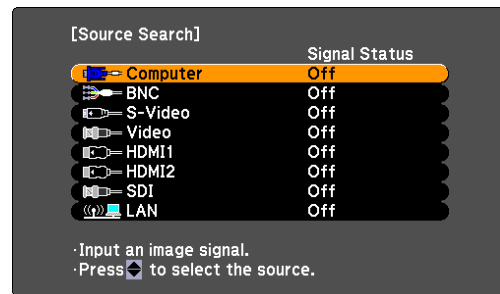

When switching to LAN, images from computers connected through the network are projected.

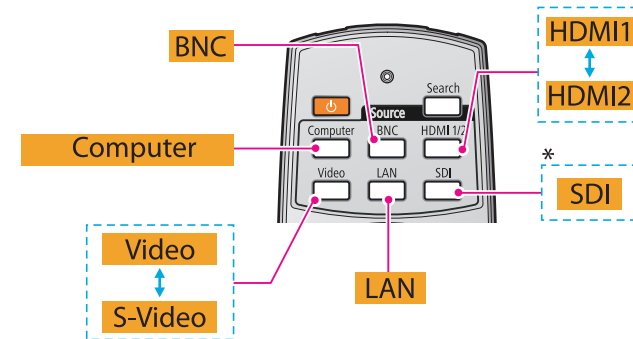

\* PowerLite Pro Z8450WUNL/Z8455WUNL only

## Switch to the Target Image using the Remote Control

You can change directly to the image from the target input port by pressing the following buttons on the remote control.  "Remote Control" [p.19](#)

## Changing the Aspect Ratio of the Projected Image

You can select the aspect mode according to the type of input signal, ratio of height and width, and resolution to switch the [Aspect Ratio](#) of the projected image. The aspect modes are listed below. The aspect modes that can be set depend on the type of image that is being projected.

### PowerLite Pro Z8350WNL/Z8450WUNL/Z8455WUNL

Aspect mode	Explanation
<b>Normal</b>	Projects to the full projection size while retaining the aspect ratio of the input image.
<b>Auto</b>	Projects in an appropriate aspect ratio based on information from the signal being input.
<b>16:9</b>	Projects to the full projection size at an aspect ratio of 16:9.
<b>16:9 (Up)</b>	Projects to the full projection size at an aspect ratio of 16:9 on the top of the screen.
<b>16:9 (Down)</b>	Projects to the full projection size at an aspect ratio of 16:9 on the bottom of the screen.
<b>Full</b>	Projects at full size.
<b>Zoom</b>	Projects the input image enlarged to the full lateral direction size as the aspect ratio remains. Parts that extend beyond the projection size are not projected.
<b>Native</b>	Projects at the resolution of the input image size to the center of the screen. This is ideal for projecting clear images.  If the image resolution exceeds the panel resolution of this projector (PowerLite Pro Z8350WNL: 1280x800, PowerLite Pro Z8450WUNL/Z8455WUNL: 1920x1200), the edges of the image are not projected.

## PowerLite Pro Z8150NL/Z8250NL/Z8255NL

Aspect mode	Explanation
<b>Normal</b>	Projects to the full projection size while retaining the aspect ratio of the input image.
<b>Auto</b>	Projects in an appropriate aspect ratio based on information from the signal being input.
<b>4:3</b>	Projects to the full projection size at an aspect ratio of 4:3. This is suitable for images at an aspect ratio of 5:4 (for example 1280x1024) at full projection size.
<b>16:9</b>	Projects at an aspect ratio of 16:9. This is suitable for projecting to the full screen size of 16:9.
<b>16:9 (Up)</b>	Projects to the full projection size at an aspect ratio of 16:9 on the top of the screen.
<b>16:9 (Down)</b>	Projects to the full projection size at an aspect ratio of 16:9 on the bottom of the screen.
<b>Native</b>	Projects at the resolution of the input image size to the center of the screen. This is ideal for projecting clear images.  If the image resolution exceeds the panel resolution of this projector (1024x768), the edges of the image are not projected.

## Procedure

### Remote Control

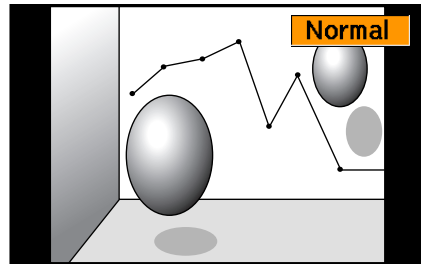
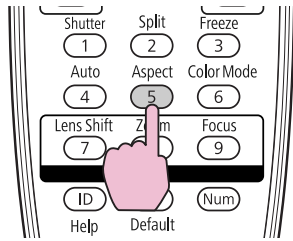

The aspect mode name is displayed on the screen by pressing the [Aspect] button.

If you press the button while the aspect mode name is displayed on the screen, it changes to the next aspect mode.



- The aspect mode can also be set using **Aspect** in the **Signal** menu from the configuration menu. [p.62](#)
- When **Scale** on the **Signal** menu is set to **On** and **Scale Mode** is set to **Full Display**, you cannot change the aspect mode.

## Changing the Aspect Mode (PowerLite Pro Z8450WUNL/Z8455WUNL)

### Projecting images from video equipment or from the HDMI1/2 or SDI input port

Each time the [Aspect] button on the remote control is pressed, the aspect mode changes in the order **Auto (Normal when projecting from the SDI input port)**, **16:9 (Up)**, **16:9 (Down)**, **Full**, **Zoom**, and **Native**. [p.27](#)

Example: 720p signal input (resolution: 1280x720, aspect ratio: 16:9)

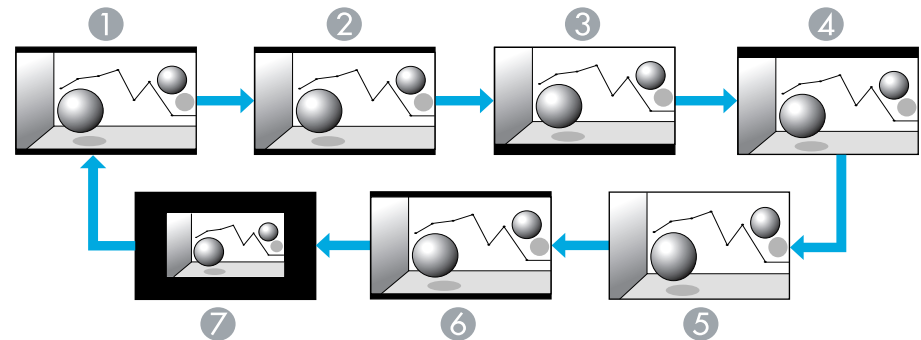

- 1 Auto/Normal
- 2 16:9
- 3 16:9 (Up)
- 4 16:9 (Down)
- 5 Full
- 6 Zoom
- 7 Native

## Projecting images from a computer

Each time the [Aspect] button on the remote control is pressed, the aspect mode changes in the order **Normal**, **16:9**, **16:9 (Up)**, **16:9 (Down)**, **Full**, **Zoom**, and **Native**.  [p.27](#)

Projection examples for each aspect mode are shown below.

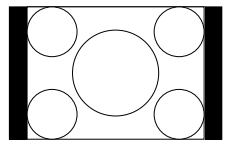
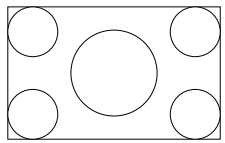
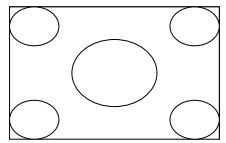
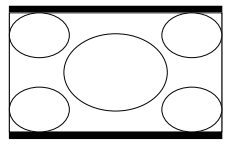
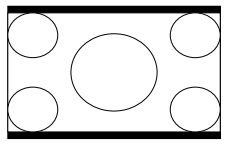
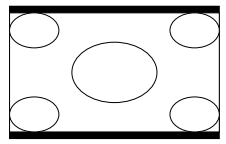
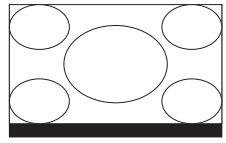
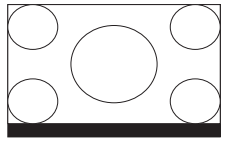
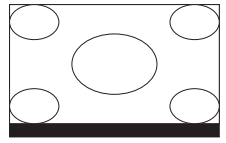
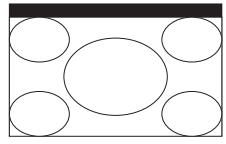
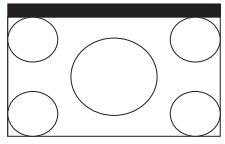
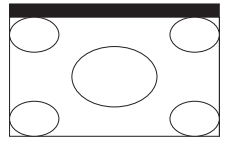
Aspect mode	Input Signal		
	XGA 1024X768 (4:3)	WXGA 1280X800 (16:10)	WUXGA 1920X1200 (16:10)
Normal			
16:9			
16:9 (Up)			
16:9 (Down)			

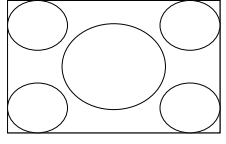
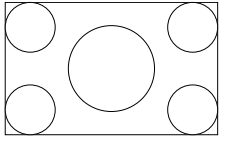
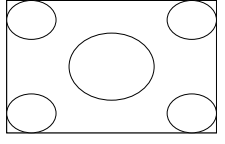
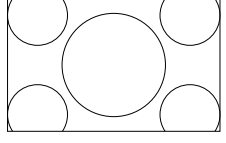
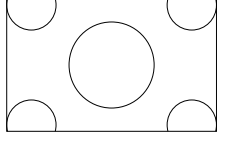
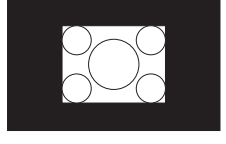
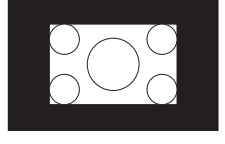
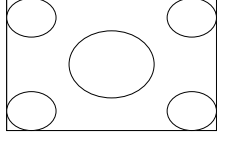
Aspect mode	Input Signal		
	XGA 1024X768 (4:3)	WXGA 1280X800 (16:10)	WUXGA 1920X1200 (16:10)
Full			
Zoom			
Native			



If parts of the image are missing or it cannot project everything, set the **Resolution** setting to **Wide** or **Normal** from the configuration menu depending on the size of the computer panel.  [p.62](#)

## Changing the Aspect Mode (PowerLite Pro Z8350WNL)

### Projecting images from video equipment or from the HDMI1/2 input port

Each time the [Aspect] button on the remote control is pressed, the aspect mode changes in the order **Auto, 16:9, 16:9 (Up), 16:9 (Down), Full, Zoom, and Native.** [p.27](#)

Example: 1080p signal input (resolution: 1920x1080, aspect ratio: 16:9)

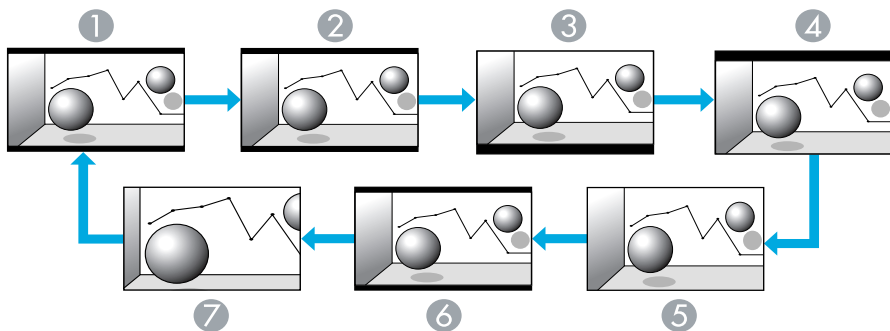

- ① Auto
- ② 16:9
- ③ 16:9 (Up)
- ④ 16:9 (Down)
- ⑤ Full
- ⑥ Zoom
- ⑦ Native

### Projecting images from a computer

Each time the [Aspect] button on the remote control is pressed, the aspect mode changes in the order **Normal, 16:9, 16:9 (Up), 16:9 (Down), Full, Zoom, and Native.** [p.27](#)

Projection examples for each aspect mode are shown below.

Aspect mode	Input Signal		
	XGA 1024X768 (4:3)	WXGA 1280X800 (16:10)	SXGA 1280X1024 (5:4)
Normal			
16:9			
16:9 (Up)			
16:9 (Down)			

Aspect mode	Input Signal		
	XGA 1024X768 (4:3)	WXGA 1280X800 (16:10)	SXGA 1280X1024 (5:4)
Full			
Zoom			
Native			



If parts of the image are missing or it cannot project everything, set the **Resolution** setting to **Wide** or **Normal** from the configuration menu depending on the size of the computer panel. [p.62](#)

## Changing the Aspect Mode (PowerLite Pro Z8150NL/Z8250NL/Z8255NL)

### Projecting images from video equipment

Each time the Aspect button on the remote control is pressed, the aspect mode changes in the order **Auto**, **4:3**, **16:9**, **16:9 (Up)**, and **16:9 (Down)**.

[p.27](#)

When inputting a 720p/1080i/1080p signal and the aspect mode is set to **4:3**, a 4:3 zoom will be applied (the right and left sides of the image will be cut off).

Example: 720p signal input (resolution: 1280x720, aspect ratio: 16:9)

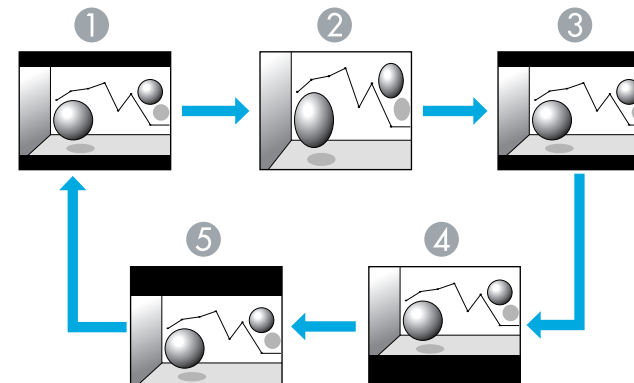

- ① Auto
- ② 4:3
- ③ 16:9
- ④ 16:9 (Up)
- ⑤ 16:9 (Down)

## Projecting images from the HDMI1/2 input port

Each time the [Aspect] button on the remote control is pressed, the aspect mode changes in the order **Auto, 4:3, 16:9, 16:9 (Up), 16:9 (Down), and Native.**  [p.27](#)

Example: 1080p signal input (resolution: 1920x1080, aspect ratio: 16:9)

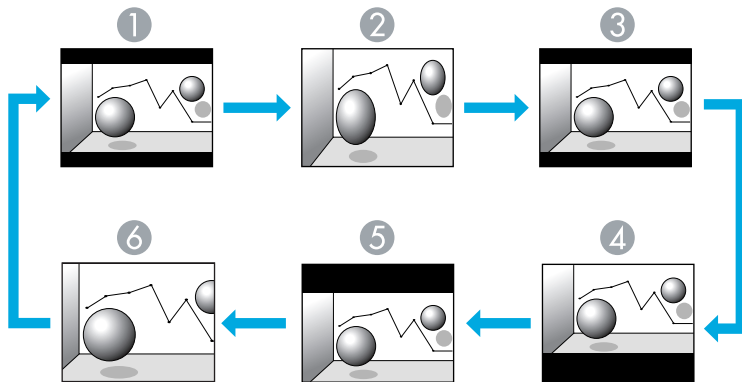

- ① Auto
- ② 4:3
- ③ 16:9
- ④ 16:9 (Up)
- ⑤ 16:9 (Down)
- ⑥ Native

## Projecting images from a computer

Each time the [Aspect] button on the remote control is pressed, the aspect mode changes in the order **Normal, 4:3, 16:9, 16:9 (Up), 16:9 (Down), and Native.**  [p.27](#)

Projection examples for each aspect mode are shown below.

Aspect mode	Input Signal		
	XGA 1024X768 (4:3)	WXGA 1280X800 (16:10)	SXGA 1280X1024 (5:4)
Normal			
4:3			
16:9			
16:9 (Up)			

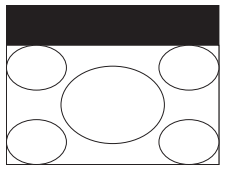
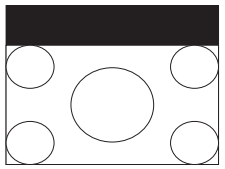
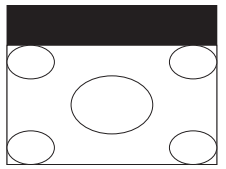
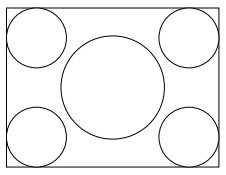
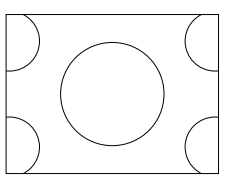
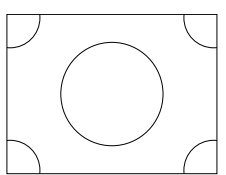

Aspect mode	Input Signal		
	XGA 1024X768 (4:3)	WXGA 1280X800 (16:10)	SXGA 1280X1024 (5:4)
16:9 (Down)			
Native			



If parts of the image are missing or it cannot project everything, set the **Resolution** setting to **Wide** or **Normal** from the configuration menu depending on the size of the computer panel. [p.62](#)

## Selecting the Projection Quality (Selecting Color Mode)

You can easily obtain the optimum image quality simply by selecting the setting that best corresponds to your surroundings when projecting. The brightness of the image varies depending on the mode selected.

Mode	Application
<b>Dynamic</b>	Ideal for use in a bright room. This is the brightest mode.
<b>Presentation</b>	Ideal for making presentations using color materials in a bright room.
<b>Theatre</b>	Ideal for watching films in a dark room. Gives images a natural tone almost like an original source.
<b>Photo</b> <sup>*1</sup>	Ideal for projecting still pictures, such as photos, in a bright room. The images are vivid and brought into contrast.
<b>Sports</b> <sup>*2</sup>	Ideal for watching TV programmes in a bright room. The images are vivid and brought to life.
<b>sRGB</b>	Ideal for images that conform to the <u>sRGB</u> color standard.
<b>DICOM SIM</b> <sup>*1</sup>	Ideal for projecting X-ray photographs and other medical images. This produces images with clear shadows.  The projector is not a medical device and cannot be used for medical diagnosis.
<b>Multi-Projection</b>	Ideal for projecting from multiple projectors. Minimize the color tone difference between each projected image.

\*1 This can be selected when inputting RGB signals, or when LAN is selected as the input source.

\*2 This can be selected when inputting component video signals, S-Video signals, or composite video signals.

## Procedure

### Remote Control

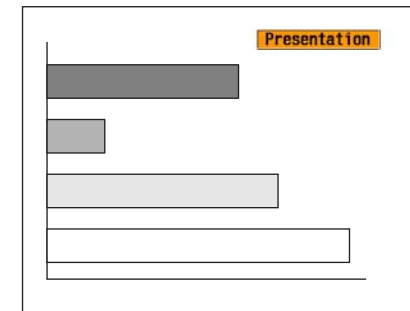
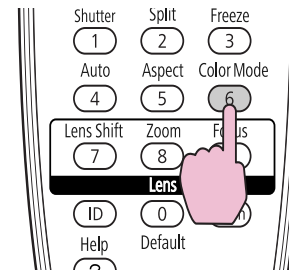

The Color Mode name is displayed on the screen by pressing the [Color Mode] button.

If you press the button while the Color Mode name is displayed on the screen, it changes to the next Color Mode.



The color mode can also be set using **Color Mode** in the **Image** menu from the configuration menu. [p.60](#)

## Projecting Two Images Simultaneously (Split Screen)

A split screen can be used to divide the screen into a left screen (A) and a right screen (B) and simultaneously project two images.

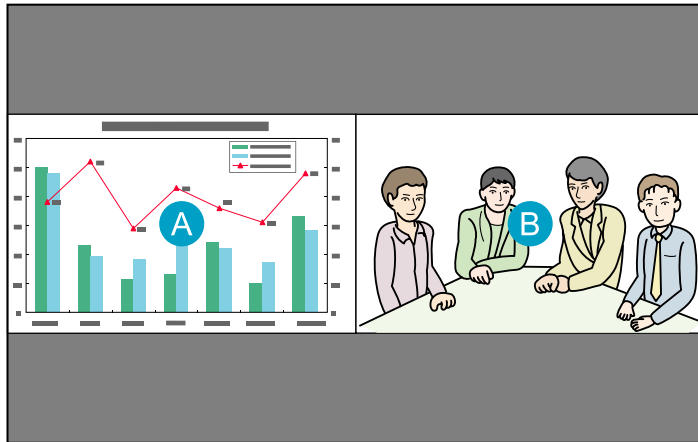

## Input Sources for Split Screen Projection

The combinations of input sources that can be projected on a split screen are listed below.

Left Screen	Right Screen							
	Computer	BNC	S-Video	Video	HDMI1	HDMI2	LAN	SDI*
Computer	-	-	✓	✓	✓	✓	✓	✓
BNC	-	-	✓	✓	✓	✓	✓	✓
S-Video	✓	✓	-	-	✓	✓	✓	✓
Video	✓	✓	-	-	✓	✓	✓	✓
HDMI1	✓	✓	✓	✓	-	-	✓	✓
HDMI2	✓	✓	✓	✓	-	-	✓	✓
LAN	✓	✓	✓	✓	✓	✓	-	-
SDI*	✓	✓	✓	✓	✓	✓	-	-

\* PowerLite Pro Z8450WUNL/Z8455WUNL only

## Operating Procedures

### Projecting on a split screen

#### Procedure

- 1 Press the [Split] button on the remote control while the projector is projecting.

The currently selected input source will be displayed on the left screen.

#### Remote Control

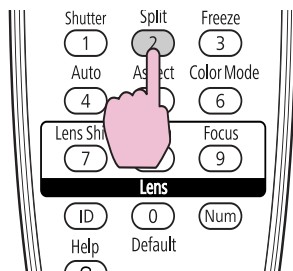

The split screen can also be started from **Split Screen** on the configuration menu. [p.65](#)



- 2 Press the [Menu] button on the remote control or the control panel.

The **Split Screen Setup** will be displayed.

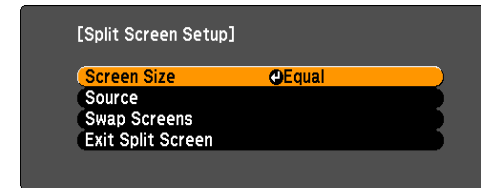

The **Split Screen Setup** will also be displayed when the [Source Search] button is pressed on the control panel or when a Source or the [Search] button is pressed on the remote control.



- 3 Select "Source" and press the [Enter] button.



- 4 Select each input source for "Left" and "Right".

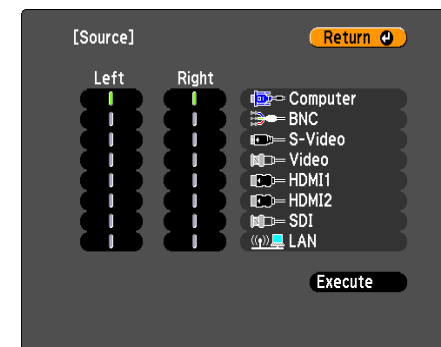

Only the input sources that can be combined can be selected. ["Input Sources for Split Screen Projection" p.35](#)

## 5 Select "Execute" and press the [Enter] button.

To switch the projected image during split screen projection, start the procedure from step 2.



Analog RGB signals that are output from the left screen can be displayed on an external monitor. [p.187](#)

## Switching the left and right screens

Use the following procedure to switch the images displayed on the left and right screens.

### Procedure

## 1 Press the [Menu] button on the remote control or the control panel during split screen projection.

## 2 Select "Swap Screens" and press the [Enter] button.

The images on the left and right screens will be swapped.

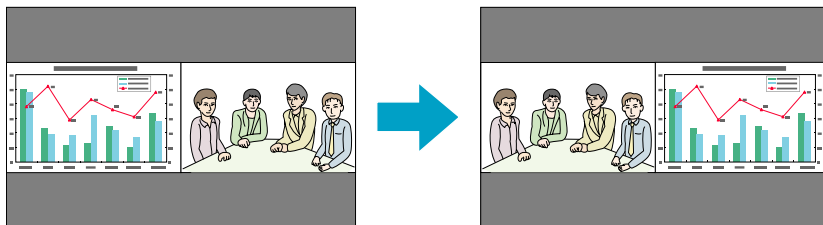

## Switching the left and right image sizes

### Procedure

## 1 Press the [Menu] button on the remote control or the control panel during split screen projection.

## 2 Select "Screen Size" and press the [Enter] button.

## 3 Select the image size to display and then press the [Enter] button.



## 4 Press the [Menu] button to end the setting procedure.

The projected images will appear as shown below after setting the screen size.

Equal



Larger Left

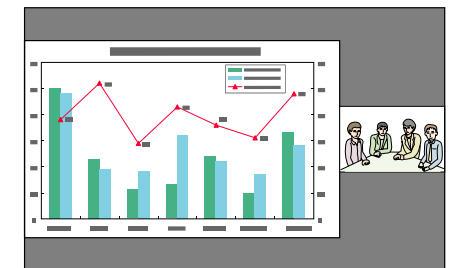

## Larger Right

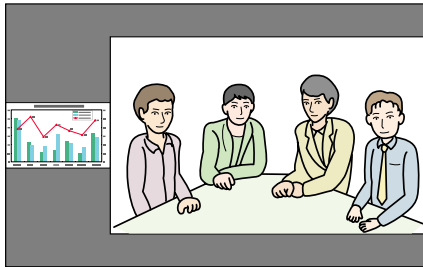

- You cannot enlarge both the left screen and right screen images at the same time.
- When one image is enlarged, the other image is reduced.
- Depending on the video signals that are input, the images on the left and right may not appear to be the same size even if **Equal** is set.

## Ending the split screen

### Procedure

To end the split screen, press the [Esc] button on the remote control or control panel.

The following steps can also be used to end the split screen.

- Press the [Split] button on the remote control.
- Select **Exit Split Screen** in the **Split Screen Setup** and then press the [Enter] button.

## Restrictions during Split Screen Projection

### Operating restrictions

The following operations cannot be performed during split screen projection.

- Setting the configuration menu
- E-zoom
- Switching the aspect mode (The aspect mode will be set to **Normal**.)  
☞ p.27
- Operations using the [User] button on the remote control
- Auto Iris

Help can be displayed only when image signals are not input or when an error or warning notification is displayed.

### Restrictions relating to images

- The default values for the **Image** menu are applied to the image on the right screen. However, the settings for the image projected on the left screen are applied to the image on the right screen for the **Color Mode**, **Abs. Color Temp.**, **Advanced**, **Super-resolution**, and **Frame Interpolation**.
- The setting value **Off** for **Progressive** and **Noise Reduction** is applied to the image on the right screen. ☞ Signal menu p.62
- When there is no image signal input, the display screen will be the color that is set on Display Background. The display will be **Blue** when the **Logo** is selected.
- When the shutter operation is performed, the display screen will be **Black**.

## Functions for Enhancing Projection

### Hiding the Image Temporarily (Shutter)

You can use this when you want to focus the audience's attention on what you are saying, or if you do not want to show details such as when you are changing between files during presentations from a computer.

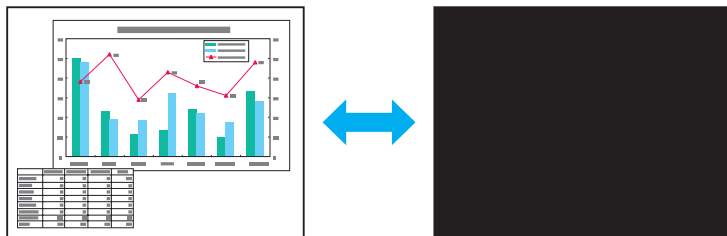

Make sure that the **Shutter Button** is set to **Electric Shutter** from **Operation** in the **Extended** menu.

#### Procedure

##### Using the Remote Control

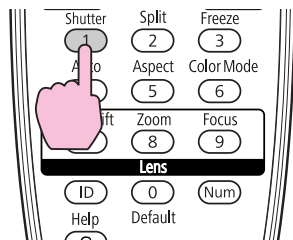

##### Using the Control Panel

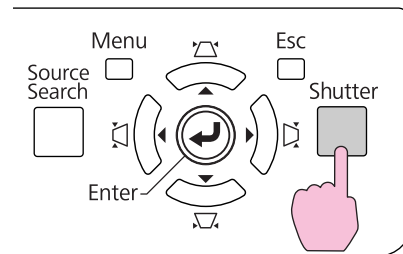

Each time you press the buttons, the electric shutter closes or opens.



- When the shutter is closed and no operations are performed for about 120 minutes, the projector enters Sleep Mode and turns off automatically. If you do not want Sleep Mode to activate, change the **Shutter Timer** setting to **Off** from **Operation** in the **Extended** menu. [p.67](#)
- If you press the [⏻] button while the shutter is closed, the shutter automatically opens and a message requesting confirmation to turn off the power is displayed on the screen.
- The Lamp1 and Lamp2 indicators flash green while the shutter is activated.
- When an event that is set in Schedule is executed, the shutter is canceled.

### Freezing the Image (Freeze)

When the freeze function is activated on moving images, the frozen image continues to be projected on the screen, so you can project a moving image one frame at a time like a still photo. Also, you can perform operations such as changing between files during presentations from a computer without projecting any images if the freeze function is activated beforehand.

#### Procedure

##### Remote Control

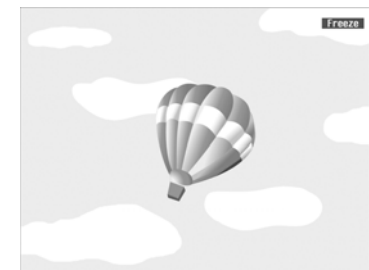
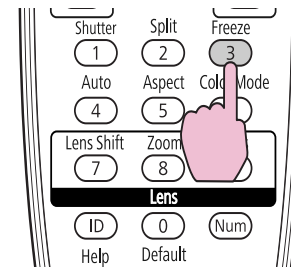

Each time you press the button, Freeze turns on or off.



- The image source continues to play back the moving images even while Freeze is on, and so it is not possible to resume projection from the point where it was paused.
- If the [Freeze] button is pressed while the configuration menu or a Help screen is displayed, the menu or Help screen being displayed is cleared.
- Freeze still works while E-Zoom is being used.

## Pointer Function (Pointer)

This allows you to move a Pointer icon on the projected image, and helps you draw attention to the area you are talking about.

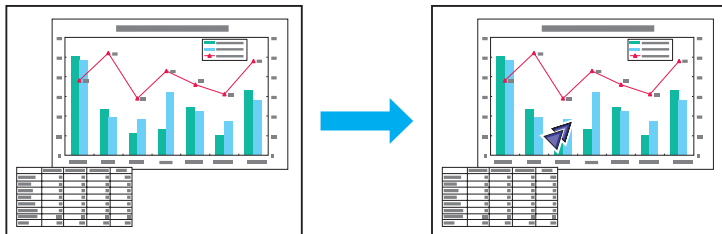

## Procedure



### 1 Display the Pointer.

#### Remote Control

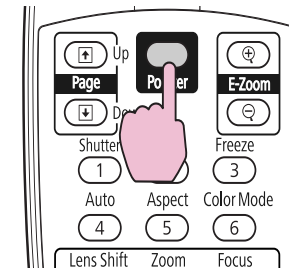

Each time you press the button, the pointer appears or disappears.



**2** Move the Pointer icon (↖).

**Remote Control**

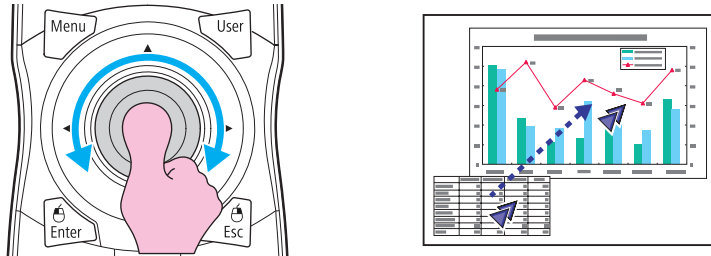

You can choose from three different kinds of Pointer icon (↖, ✖, or ↗) in **Settings - Pointer Shape** from the configuration menu.

👉 p.65

**Procedure**

**1** Start E-Zoom.

**Remote Control**

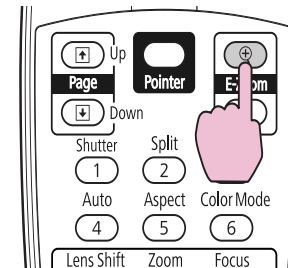

**2** Move the (⊕) to the area of the image that you want to enlarge.

**Remote Control**

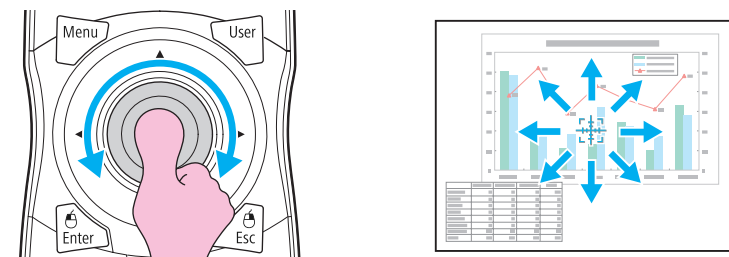

## Enlarging Part of the Image (E-Zoom)

This is useful when you want to expand images to see them in greater detail, such as graphs and tables.

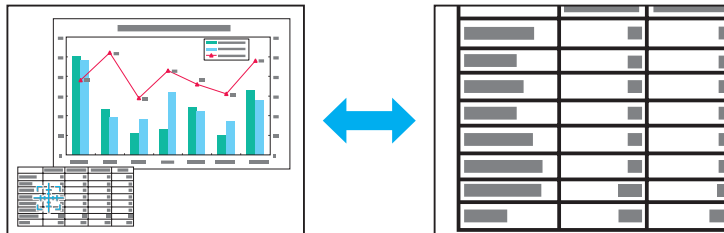

## 3 Enlarge.

### Remote Control

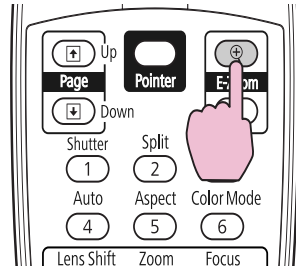

Each time the button is pressed, the area is expanded. You can expand quickly by holding the button down.

You can reduce the enlarged image by pressing the [⊖] button.

Press the [Esc] button to cancel.



- The enlargement ratio appears on the screen. The selected area can be enlarged between 1 to 4 times in 25 incremental steps.
- Use the [⊕] button to scroll through the enlarged image.
- E-Zoom is canceled when performing some functions such as keystone or Auto Setup.
- When Scale is set to On, E-Zoom cannot be used.

## Saving a User's Logo

You can save the image that is currently being projected as a User's Logo.

The saved user's logo can be used as the display image when there is no video signal input or during starting up.



Once a User's Logo has been saved, the logo cannot be returned to the factory default.

## Procedure

- 1 **Project the image you want to use as the User's Logo, and then press the [Menu] button.**

### Using the Remote Control

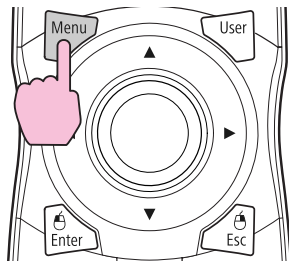

### Using the Control Panel

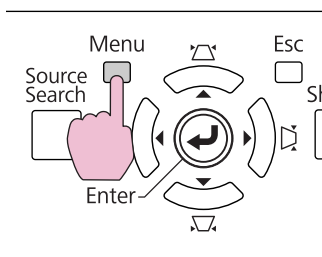

- 2 **Select Extended - "User's Logo" from the configuration menu.** ["Using the Configuration Menu" p.55](#)

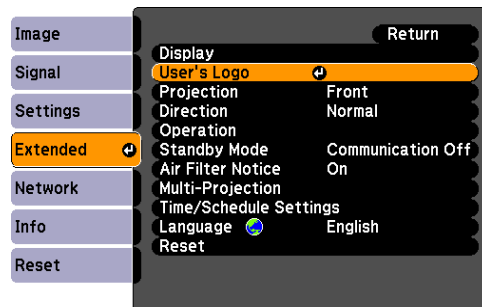

- If **User's Logo Protect** from **Password Protect** is set to **On**, a message is displayed and the user's logo cannot be changed. You can make changes after setting **User's Logo Protect** to **Off**. [p.45](#)
- If **User's Logo** is selected when keystone, E-Zoom, or Aspect are being performed, the function currently being performed is cancelled.



**3 When "Choose this image as the User's Logo?" is displayed, select "Yes".**



When you press the [Enter] button on the remote control or the control panel, the screen size may change according to the signal as it changes to the resolution of the image signal.

- 4** Move the box to select the part of the image to use as the User's Logo.

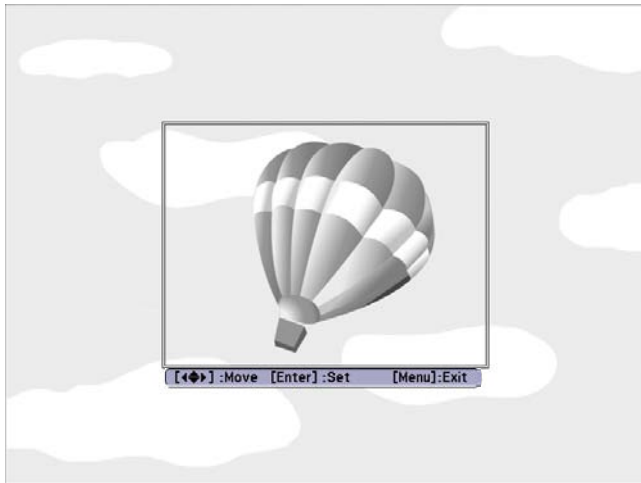

**Using the Remote Control**

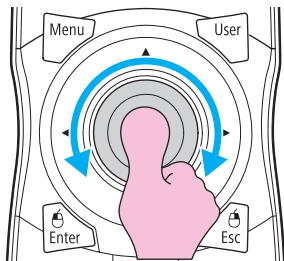

**Using the Control Panel**

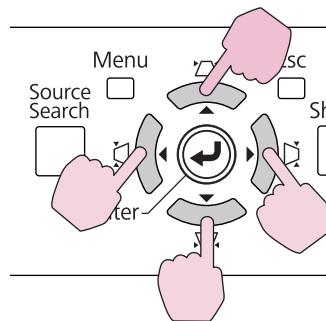

 Your User's Logo image can have a resolution up to 400 × 300.

- 5** When "Select this image?" is displayed, select "Yes".

- 6** Select the zoom factor from the zoom setting screen.

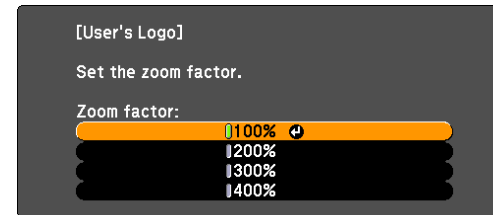

400% is displayed only when using PowerLite Pro Z8450WUNL/Z8455WUNL.

- 7** When the message "Save this image as the User's Logo?" is displayed, select "Yes".

The image is saved. After the image has been saved, the message "Completed." is displayed.



- To use the saved user's logo as the screen image, set it in the **Display** settings under the **Extended** menu.  p.67
- Saving the user's logo may take approximately 15 seconds. Do not use the projector or any connected equipment while it is saving, otherwise malfunctions may occur.

## Security Functions

The projector has the following enhanced security functions.

- Password Protect  
You can limit who can use the projector.
- Control Panel Lock/Lens Operation Lock/Remote control button lock  
You can prevent people changing the settings on the projector without permission.  p.47
- Theft-Deterrent Lock

The projector is equipped with various types of theft-deterrent security devices.  p.50

## 2. User's Logo Protect

Even if someone tries to change the User's Logo set by the owner of the projector, it cannot be changed. When **User's Logo Protect** is set to **On**, the following setting changes for the User's Logo are prohibited.

- Capturing a User's Logo
- Settings for **Display Background**, and **Startup Screen** from **Display** in the configuration menu

## 3. Network Protect

When **Network Protect** is set to **On**, setting changes for **Network** menu in the configuration menu are prohibited.

## Managing Users (Password Protect)

When Password Protect is activated, people who do not know the password cannot use the projector to project images even if the projector power is on. Furthermore, the user's logo that is displayed when you turn on the projector cannot be changed. This acts as a theft-deterrent since the projector cannot be used even if it is stolen. At the time of purchase, Password Protect is not activated.

## Type of Password Protect

The following three kinds of Password Protect settings can be made according to how the projector is being used.

### 1. Power On Protect

When **Power On Protect** is **On**, you need to enter a preset password after the projector is plugged in and turned on (this also applies to Direct Power On). If the correct password is not entered, projection does not start.

## Setting Password Protect

Use the following procedure to set Password Protect.

### Procedure



**During projection, hold down the [Freeze] button for about five seconds.**

The Password Protect setting menu is displayed.

### Remote Control

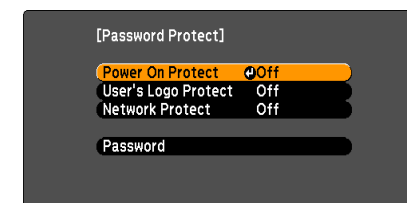
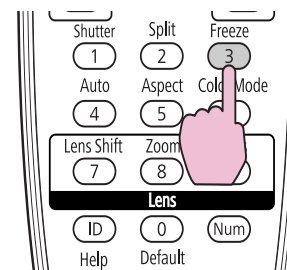



- If **Password Protect** is already activated, you must enter the password. If the password is entered correctly, the **Password Protect** setting menu is displayed. ➡ "Entering the Password" p.46
- When the password is set, stick the **Password protect** sticker in a visible position on the projector as a further theft-deterrent.

## 2

### Turn on "Power On Protect".

- (1) Select **Power On Protect**, and then press the [Enter] button.
- (2) Select **On**, and then press the [Enter] button.
- (3) Press the [Esc] button.

## 3

### Turn on "User's Logo Protect".

- (1) Select **User's Logo Protect**, and then press the [Enter] button.
- (2) Select **On**, and then press the [Enter] button.
- (3) Press the [Esc] button.

## 4

### Turn on "Network Protect".

- (1) Select **Network Protect**, and then press the [Enter] button.
- (2) Select **On**, and then press the [Enter] button.
- (3) Press the [Esc] button.

## 5

### Set the Password.

- (1) Select **Password**, and then press the [Enter] button.
- (2) The message "Change the password?" is displayed, select **Yes** and then press the [Enter] button. The default setting for the Password is "0000". Change this to your own desired password. If you select **No**, the screen shown in step 1 is displayed again.

- (3) While holding down the [Num] button, enter a four digit number using the numeric buttons. The number entered is displayed as "\* \* \* \*". When you enter the fourth digit, the confirmation screen is displayed.

### Remote Control

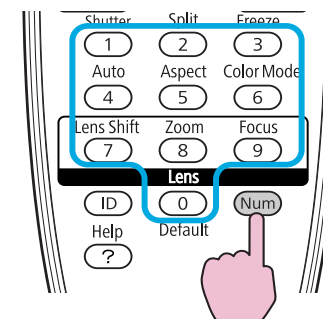

- (4) Re-enter the password. The message "Password accepted." is displayed. If you enter the password incorrectly, a message is displayed prompting you to re-enter the password.

## Entering the Password

When the Password entry screen is displayed, enter the password using the numeric buttons on the remote control.

### Procedure

#### While holding down the [Num] button, enter the password by pressing the numeric buttons.

When you enter the correct password, projection begins.

## Caution

- If an incorrect password is entered three times in succession, the message "**The projector's operation will be locked.**" is displayed for about five minutes, and then the projector switches to standby mode. If this happens, disconnect the power plug from the electrical outlet and then reinsert it and turn the projector's power back on. The projector displays the Password entry screen again so that you can enter the correct password.
- If you have forgotten the password, make a note of the "Request Code: xxxxx" number that appears on the screen and contact Epson. 🖱️ [p.114](#)
- If you continue to repeat the above operation and input the wrong Password thirty times in succession, the following message is displayed and the projector does not accept any more Password entries. "**The projector's operation will be locked. Contact Epson.**" 🖱️ [p.114](#)

## Restricting Button Operation

The following three kinds of operation restriction functions are available with the projector.

- Control Panel Lock  
This is useful at events or shows when you want to deactivate all buttons during projection or at schools when you want to limit button operation.
- Lens Operation Lock  
This function deactivates all buttons on the remote control related to the lens operation to prevent improper lens adjustment after it is properly adjusted.
- Remote control button lock  
This function deactivates all buttons on the remote control except for the buttons needed for basic remote control operation.

## Control Panel Lock

Perform one of the following to lock the operation buttons on the control panel. Even if the control panel is locked, you can still use the remote control as usual.

- Full Lock  
All of the buttons on the control panel are locked. You cannot perform any operations from the control panel, including turning the power on or off.
- Partial Lock  
All of the buttons on the Control panel, except for the [⏻] button, are locked.

## Procedure

- 1 During projection, press the [Menu] button and select Settings - "Control Panel Lock" from the configuration menu. 🖱️ "Using the Configuration Menu" [p.55](#)

Using the Remote Control

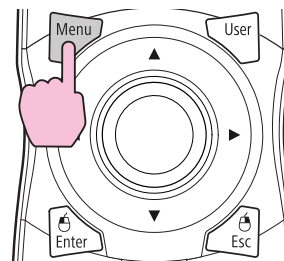

Using the Control Panel

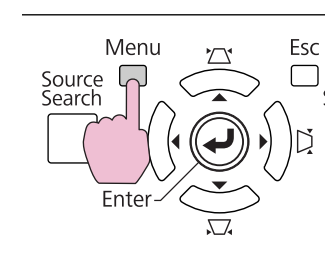

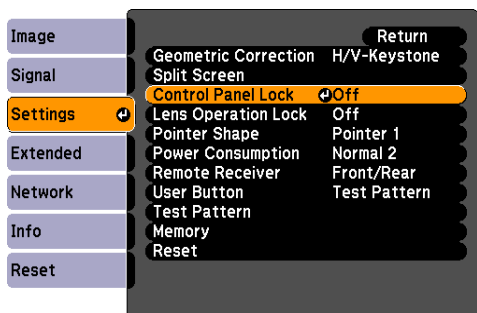

**2** Select either "Full Lock" or "Partial Lock" according to your purpose.

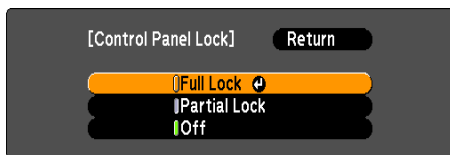

**3** Select "Yes" when the confirmation message is displayed.

The control panel buttons are locked according to the setting you chose.



You can release the control panel lock by one of the following two methods.

- From the remote control, select **Off** in **Settings - Control Panel Lock** from the configuration menu. [p.65](#)
- Press and hold down the [Enter] button on the control panel for about seven seconds, a message is displayed and the lock is released.

## Lens Operation Lock

This function locks the following buttons on the remote control related to the lens operation.

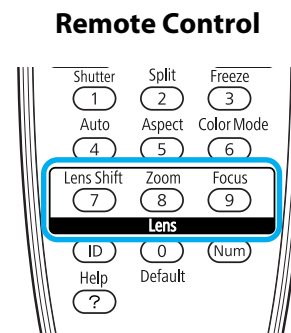

### Procedure

**1** Press the [Menu] button, and select Settings - "Lens Operation Lock" from the configuration menu. ["Using the Configuration Menu" p.55](#)

#### Using the Remote Control

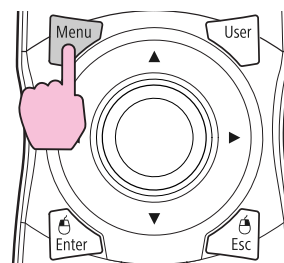

#### Using the Control Panel

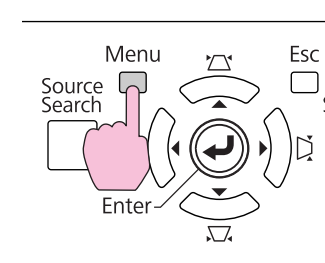



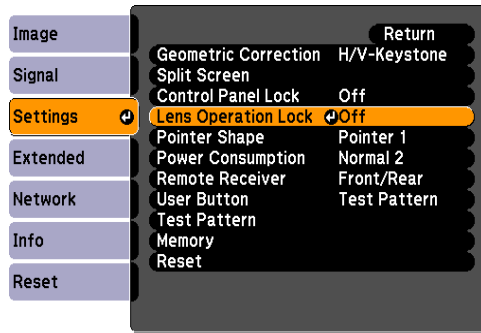

2 Select "On".

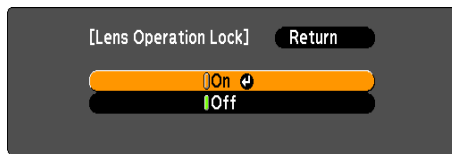

The buttons related to the lens operation are locked according to the setting you chose.

## Remote control button lock

This function locks the following buttons on the remote control.

### Remote Control

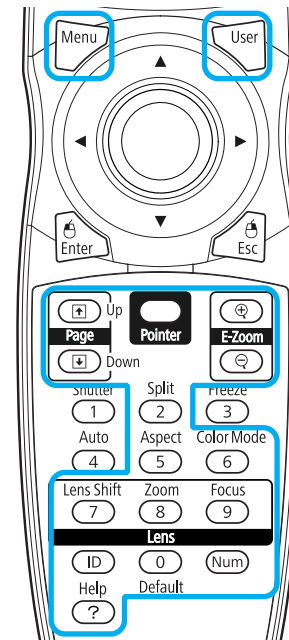

## Procedure

### Remote Control

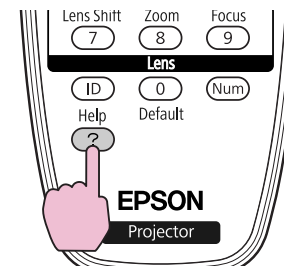

Each time the [Help] button is pressed for at least 5 seconds, the remote control button lock turns on or off.



Even if the remote control button lock is on, the following operations are possible.

- *Resetting the Remote Receiver setting to its default*
- *Entering numbers using the [Num] button and the numeric buttons*

---

## Theft-Deterrent Lock

As the projector is often setup on ceiling mounts and left in rooms unattended, the projector includes the following security devices to prevent someone from taking the projector.

- Security slot  
The Security slot is compatible with the Microsaver Security System manufactured by Kensington.
- Handle  
A commercially available theft-deterrent wire lock can be passed through the security cable installation point to secure the projector to a desk or pillar.

## Installing the wire lock

Pass an theft-deterrent wire lock through the handle.

See the documentation supplied with the wire lock for locking instructions.

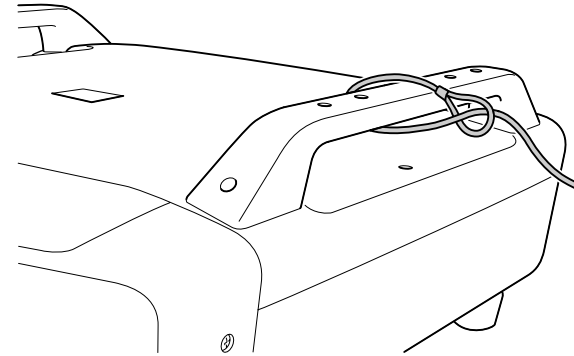

## Memory Function

Image settings in the configuration menu can be saved to memory, and can be recalled when needed. You can save up to ten sets of image settings to memory.

## Available Settings

Setting items in the configuration menu that can be saved to memory are listed below.

Top Menu	Sub Menu
Image	All setting items
Signal	Progressive Frame Interpolation* <sup>1</sup> Super-resolution Noise Reduction Mosquito NR HDMI Video Range SDI Video Range* <sup>1</sup> Scale Overscan
Settings	Power Consumption* <sup>2</sup>
Extended	Brightness Level* <sup>2</sup> Edge Blending Multi-screen

\*1 PowerLite Pro Z8450WUNL/Z8455WUNL only

\*2 Not available on PowerLite Pro Z8150NL

## Saving/Loading/Erasing the Memory

### Saving to memory

Use the following procedure to save your image settings to memory.

#### Procedure

- 1 During projection, press the [Menu] button on the remote control or control panel, and select Settings - "Memory" from the configuration menu.  "Using the Configuration Menu" p.55

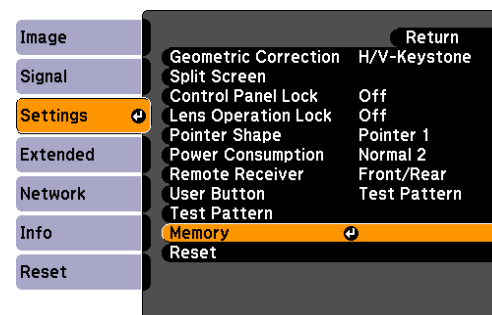

- 2 Select "Save Memory", and then press the [Enter] button.

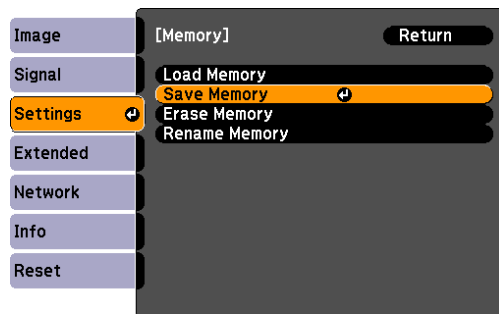

- 3 Select the memory name that you want to save your image settings to, and then press the [Enter] button.

Current settings are saved to memory.



Saved settings are indicated by a green highlight to the left of the memory name. If you select a name that is already in use, the existing settings will be erased and new ones saved in their place.

## Loading a saved memory

### Procedure

- 1 During projection, press the [Menu] button on the remote control or control panel, and select Settings - "Memory" from the configuration menu.
- 2 Select "Load Memory", and then press the [Enter] button.

- 3 Select the desired memory, and then press the [Enter] button.

The settings saved to the memory are applied to the projected image.

## Erasing a saved memory

### Procedure

- 1 Press the [Menu] button on the remote control or control panel, and select Settings - "Memory" from the configuration menu.
- 2 Select "Erase Memory", and then press the [Enter] button.
- 3 Select the desired memory, and then press the [Enter] button.
- 4 Select "Yes" when the confirmation message is displayed.

The settings in the saved memory will be erased.

## Renaming a saved memory

### Procedure

- 1 Press the [Menu] button on the remote control or control panel, and select Settings - "Memory" from the configuration menu.
- 2 Select "Rename Memory", and then press the [Enter] button.

**3** Select the desired memory, and then press the [Enter] button.

**4** Enter the memory name using the soft keyboard.  "Soft Keyboard Operations" [p.72](#)

Press [Finish] to complete renaming.

# Configuration Menu

This chapter explains how to use the configuration menu and its functions.

The screen shots may be different from those shown in this chapter depending on your projector model.

## Using the Configuration Menu

1

Selecting from the top menu



2

Selecting from the sub menu



3

Setting each item

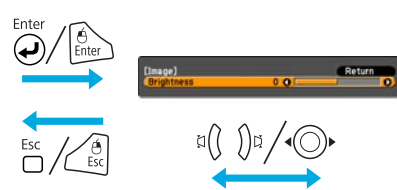

4

Exit

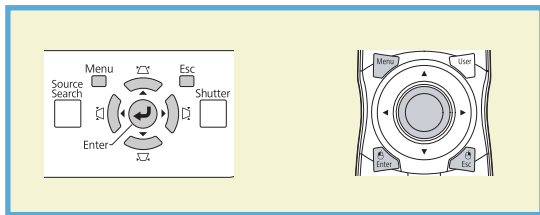
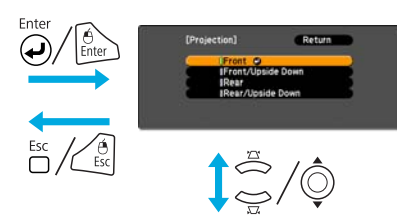
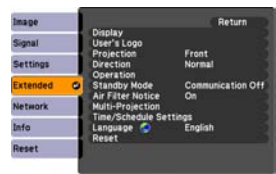
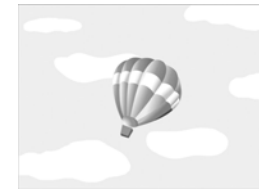

## Configuration Menu

Items that can be set vary depending on the image signal or input source currently being projected, or the model you are using.

Top Menu	Sub Menu	Items/Values
Image Menu  p.60	Color Mode	Dynamic, Presentation, Theatre, Photo, Sports, sRGB, DICOM SIM, Multi-Projection
	Brightness	-24 to 24
	Contrast	-24 to 24
	Color Saturation	-32 to 32
	Tint	-32 to 32
	Sharpness	-5 to 5
	Abs. Color Temp.	5000K to 10000K
	Advanced	Gamma, RGB, RGBCMY
	Auto Iris	On, Off

Top Menu	Sub Menu	Items/Values
Signal Menu  p.62	Auto Setup	On, Off
	Resolution	Auto, Wide, Normal, Manual
	Tracking	-
	Sync.	-
	Position	-
	Progressive	Off, Video, Film/Auto
	Frame Interpolation <sup>*1</sup>	Off, Low, Normal, High
	Super-resolution	0 to 3
	Noise Reduction	Off, NR1, NR2
	Mosquito NR	On, Off
	HDMI Video Range	Auto, Normal, Expanded
	SDI Video Range <sup>*1</sup>	Normal, Expanded
	Input Signal	Auto, RGB, Component
	Video Signal	Auto, NTSC, NTSC4.43, PAL, M-PAL, N-PAL, PAL60, SECAM
	Aspect	Normal, Auto, 4:3, 16:9, 16:9 (Up), 16:9 (Down), Full, Zoom, Native
	Scale	-
	Overscan	Auto, Off, 4%, 8%



Top Menu	Sub Menu	Items/Values
Settings Menu  p.65	Geometric Correction	H/V-Keystone, Quick Corner, Arc Correction, Point Correction
	Split Screen	-
	Control Panel Lock	Full Lock, Partial Lock, Off
	Lens Operation Lock	On, Off
	Pointer Shape	Pointer 1, 2, 3
	Power Consumption <sup>*2</sup>	Normal 1, ECO, Normal 2
	Remote Receiver	Front/Rear, Front, Rear, Off
	User Button	Power Consumption <sup>*2</sup> , Info, Progressive, Closed Caption, Test Pattern, Multi-screen, Resolution, Memory
	Test Pattern	-
	Memory	Load Memory, Save Memory, Erase Memory, Rename Memory

Top Menu	Sub Menu	Items/Values
Extended Menu ☛ p.67	Display	Menu Position, Messages, Display Background, Startup Screen, Panel Alignment
	Closed Caption	CC1, CC2, Off
	User's Logo	-
	Projection	Front, Front/UpSide Down, Rear, Rear/UpSide Down
	Direction	Normal, Pointing Up, Pointing Down, Angled Up, Angled Down
	Operation	Direct Power On, Sleep Mode, Sleep Mode Timer, Shutter Button, Shutter Timer, High Altitude Mode, BNC Sync Termination, Remote Control Type, Beep
	Standby Mode	Communication On, Communication Off
	Air Filter Notice	On, Off
	Multi-Projection	Brightness Level*2, Edge Blending, Multi-screen, Projector ID
	Time/Schedule Settings	-
Language	27 languages	

Top Menu	Sub Menu	Items/Values
Info Menu ☛ p.89	Lamp Hours	-
	Lamp Status	-
	Source	-
	Input Signal	-
	Resolution	-
	Video Signal	-
	Refresh Rate	-
	Sync Info	-
	Status	-
	Serial Number	-
Reset Menu ☛ p.91	Event ID	-
	Reset All	-
	Reset Memory	-

\*1 PowerLite Pro Z8450WUNL/Z8455WUNL only

\*2 Not available on PowerLite Pro Z8150NL

## Network Menu

Top Menu	Sub Menu	Items/Values
Basic Menu ☛ p.73	Projector Name	-
	Web Remote Password	-
	Projector Keyword	On, Off

Top Menu	Sub Menu	Items/Values
Wireless LAN Menu ☛ p.74	Wireless LAN Power	On, Off
	Wi-Fi Protected Setup	-
	Wireless LAN system	802.11b/g/n, 802.11b/g
	Connection Mode	Quick, Advanced
	SSID Auto Setting	On, Off
	SSID	-
	Search Access Point	-
	Channel	1ch, 6ch, 11ch
	SSID Display	On, Off
	DHCP	On, Off
	IP Address	-
	Subnet Mask	-
	Gateway Address	-
	IP Address Display	On, Off
Region Code	-	
Security Menu ☛ p.77	Security	Open, WPA/WPA2-PSK, WPA/WPA2-EAP
Wired LAN Menu ☛ p.81	DHCP	On, Off
	IP Address	-
	Subnet Mask	-
	Gateway Address	-
	IP Address Display	On, Off

Top Menu	Sub Menu	Items/Values
Administrator Settings Menu ☛ p.82	Administrator Password	-
	Network Host Name	-
	PJLink Password	-
	Web Control Password	-
	Monitor Password	-
	Secure HTTP	On, Off
	Mail Notification	-
	Manage Certificates	-
	SNMP	-
	Priority Gateway	Wired, Wireless
	AMX Device Discovery	On, Off
	Crestron RoomView	On, Off
	Bonjour	On, Off
	EPSON Message Broadcasting	On, Off

## Image Menu

Items that can be set vary depending on the image signal or input source currently being projected as shown in the following screen shots. Setting details are saved for each image signal.

### RGB Signal/LAN

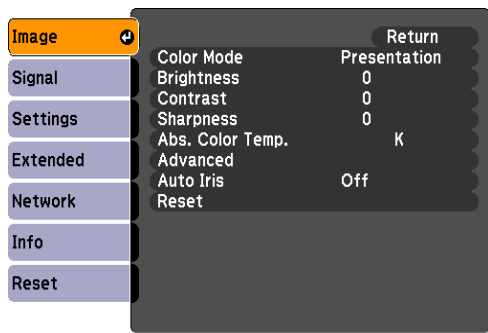

### Component Video Signal▶▶/ Composite video Signal▶▶/S-Video Signal▶▶

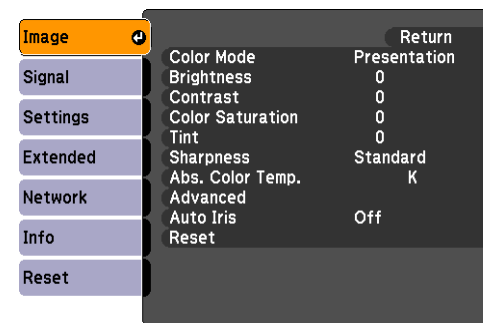

Sub Menu	Function
<b>Color Mode</b>	You can select the quality of the image to suit your surroundings. 🖱️ <a href="#">p.34</a>
<b>Brightness</b>	You can adjust the image brightness.
<b>Contrast▶▶</b>	You can adjust the difference between light and dark areas in the image.
<b>Color Saturation</b>	You can adjust the color saturation for the images.
<b>Tint</b>	You can adjust the image tint.
<b>Sharpness</b>	<p><b>Standard:</b> You can adjust the image sharpness. To make more-detailed settings, select <b>Advanced</b>.</p> <p><b>Advanced:</b> The following four items can be set.</p> <p><b>Thin Line Enhancement:</b> If this parameter is set to a positive value, details such as hair or fabric patterns will be enhanced.</p> <p><b>Thick Line Enhancement:</b> If this parameter is set to a positive value, the outline, background, and the other main parts of the objects in the image will be enhanced to show them clearly.</p> <p><b>Vert. Line Enhancement:</b> If this parameter is set to a positive value, vertical lines in the image are enhanced.</p> <p><b>Horiz. Line Enhancement:</b> If this parameter is set to a positive value, horizontal lines in the image are enhanced.</p>

Sub Menu	Function
<b>Abs. Color Temp.</b>	You can adjust the overall tint of the image. You can adjust tints in 10 stages from 5000 K to 10000 K. When a high value is selected, the image becomes tinged with blue, when a low value is selected, the image becomes tinged with red.
<b>Advanced</b>	<p>You can make adjustments by choosing the following items.</p> <p><b>Gamma:</b> You can select one of the gamma correction values, or customize your own setting from your image or a displayed graph.</p> <p><b>RGB:</b> You can adjust the offset and gain for each signal color (red, green, and blue).</p> <p><b>RGBCMY:</b> You can adjust the hue, saturation, and brightness of each color R (red), G (green), B (blue), C (cyan), M (magenta), Y (yellow) individually.</p>
<b>Auto Iris</b> *	<p>(This item can be selected when <b>Dynamic</b> or <b>Theatre</b> is selected as the <b>Color Mode</b> setting from the <b>Image</b> menu.)</p> <p>Set whether or not (<b>On/Off</b>) to adjust to the optimum light status for images being projected.</p> <p>The setting is stored for each Color Mode.</p>
<b>Reset</b>	You can reset all adjustment values for the <b>Image</b> menu functions to their default settings. To return all menu items to their default settings, see  <a href="#">p.91</a>

\* This item cannot be set if **Edge Blending** is set to **On**.

## Signal Menu

Items that can be set vary depending on the image signal or input source currently being projected as shown in the following screen shots. Setting details are saved for each image signal.

You cannot change settings in the Signal menu other than Scale when projecting from a network source.

### RGB Signal

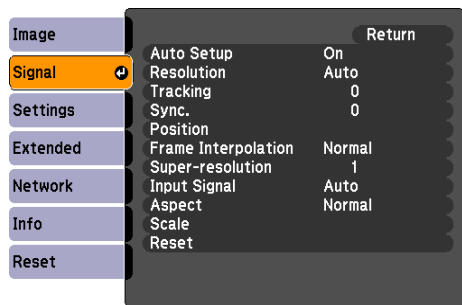

### Component Video Signal▶▶

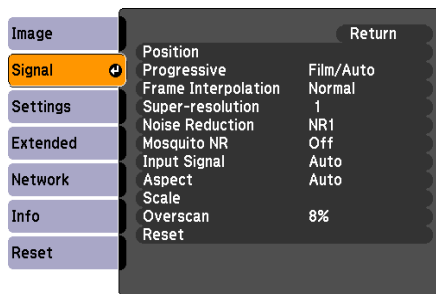

### Composite video Signal▶▶/S-Video Signal▶▶

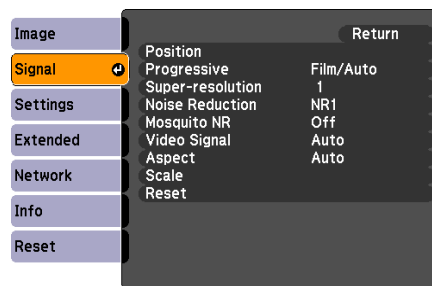

### HDMI/SDI\*

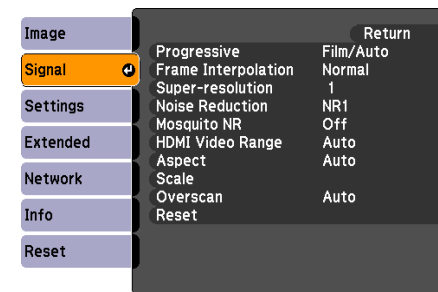

\* PowerLite Pro Z8450WUNL/Z8455WUNL only

Sub Menu	Function
<b>Auto Setup</b>	You can select whether or not ( <b>On/Off</b> ) Auto Setup automatically adjusts the image to the optimum state when the input signal changes.
<b>Resolution</b>	<b>Auto:</b> The resolution of the input signal is automatically identified. <b>Wide, Normal:</b> If the images cannot be projected correctly when <b>Auto</b> is selected, change this setting depending on the size of the connected computer screen; <b>Wide</b> for wide screens and <b>Normal</b> for 4:3 or 5:4 screens. <b>Manual:</b> You can specify the resolution. This is ideal when connected computer is fixed.
<b>Tracking▶▶</b>	You can adjust computer images when vertical stripes appear in the images.
<b>Sync.▶▶</b>	You can adjust computer images when flickering, fuzziness, or interference appear in the images.
<b>Position</b>	You can adjust the display Position up, down, left, and right when a part of the image is missing so that the whole image is projected.
<b>Progressive</b>	<b>Off:</b> IP conversion is carried out for each field in the screen. This is ideal for viewing images with a large amount of movement. <b>Video:</b> This is ideal for viewing general video images. <b>Film/Auto:</b> By automatically converting movie films, CG, animated images, and so on recorded in 24/30 frames to the optimum progressive signal via 2-3 pull-down, it is possible to recreate the natural feel of the original image.

Sub Menu	Function
<b>Frame Interpolation</b> *	You can play fast moving images smoothly by producing intermediate frames between the original frames.
<b>Super-resolution</b>	Sharpens the image of a low resolution or blurry picture.
<b>Noise Reduction</b>	Smooths out rough images. There are two modes. Select your favorite setting. It is recommended that this is set to <b>Off</b> when viewing image sources in which noise is very low, such as for DVDs.
<b>Mosquito NR</b>	You can reduce the wavy noise that occurs in lines between areas with dramatic changes in colors.
<b>HDMI Video Range</b>	When the HDMI1/2 input port is connected to a DVD player, set the video level according to the video level setting of the DVD player. If <b>Auto</b> is selected, the video level of the input signal is identified and set automatically. If the range is set to <b>Auto</b> and the image shows whiteout or blackout, set the video level according to the video level setting of the DVD player. The video level of the DVD player may be set to Normal or Expanded.
<b>SDI Video Range</b> *	When the SDI input port is connected to a video equipment, set the video level according to the video level setting of the video equipment.
<b>Input Signal</b>	You can select the signal type for input sources connected to the Computer input port or BNC input port. If <b>Auto</b> is set, the input signal is identified automatically according to the connected equipment. If colors do not appear correctly when this is set to <b>Auto</b> , select the appropriate signal according to the connected equipment.
<b>Video Signal</b>	You can select the signal type for input sources connected to the Video input port or S-Video input port. If set to <b>Auto</b> , video signals are recognized automatically. If interference appears in the image or a problem occurs such as no image is being projected when set to <b>Auto</b> , select the appropriate signal according to the connected equipment.
<b>Aspect</b>	You can set the <u>Aspect Ratio</u> ▶ for projected images. 🖱️ p.27
<b>Scale</b>	When you set <b>Edge Blending</b> from Extended menu, you can adjust an overlapping area, scaling up each image and selecting the range to display. <b>Full Display:</b> You can adjust while renewing the display area aspect and position. <b>Zoom Display:</b> You can adjust while locking the display area aspect and position.
<b>Overscan</b>	You can change the Output Scaling (the range of projected image). The range of trimming can be set to <b>Off</b> , <b>4%</b> , or <b>8%</b> . You can select <b>Auto</b> only when the input source is <b>HDMI1/2</b> . When <b>Auto</b> is selected, the range is automatically switched to <b>Off</b> or <b>8%</b> according to the input signal.
<b>Reset</b>	You can reset all adjustment values on the <b>Signal</b> menu to their default settings, except for <b>Input Signal</b> . To return all menu items to their default settings, see 🖱️ p.91





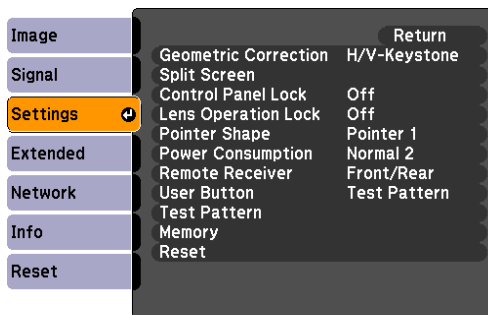

\* PowerLite Pro Z8450WUNL/Z8455WUNL only



## Settings Menu



Sub Menu	Function
<b>Geometric Correction</b>	<p>You can correct distortion.</p> <p><b>H/V-Keystone:</b> Corrects horizontal and vertical keystone distortion. Select one of <b>V-Keystone</b> or <b>H-Keystone</b>.  <a href="#">p.166</a></p> <p>Use the [<math>\nabla</math> / <math>\blacktriangle</math>], [<math>\nabla</math> / <math>\blacktriangledown</math>], [<math>\blacktriangleleft</math> / <math>\blacktriangleright</math>], and [<math>\blacktriangledown</math> / <math>\blacktriangleright</math>] buttons on the control panel to perform similar corrections to <b>V-Keystone</b> and <b>H-Keystone</b>.</p> <p><b>Quick Corner:</b> Selects and corrects the four corners of the projected image.  <a href="#">p.164</a></p> <p><b>Arc Correction:</b> Fine adjustment of the curved distortion caused by slack or shrinkage of the screen.  <a href="#">p.168</a></p> <p><b>Point Correction:</b> The projected image is divided by the grid, and you can correct the distortion by moving the point of intersection from side to side and up and down.  <a href="#">p.178</a></p>
<b>Split Screen</b>	You can split the screen into two screens. <a href="#">p.35</a>
<b>Control Panel Lock</b>	You can use this to restrict operation of the projector's control panel. <a href="#">p.47</a>
<b>Lens Operation Lock</b>	You can use this to restrict the lens operation of the remote control. <a href="#">p.48</a>
<b>Pointer Shape</b>	<p>You can select the shape of the pointer.  <a href="#">p.40</a></p> <p><b>Pointer 1:</b> <b>Pointer 2:</b> <b>Pointer 3:</b> </p>

Sub Menu	Function
<b>Power Consumption</b> *	<p>You can set the lamp brightness to <b>Normal 1</b>, <b>ECO</b>, or <b>Normal 2</b>.</p> <p><b>Normal 1:</b> Projects at normal brightness. You can change the lamp brightness in <b>Multi-Projection - Brightness Level</b> from the Extended menu.  <a href="#">p.67</a></p> <p><b>ECO:</b> Select this if the images being projected are too bright such as when projecting images in a dark room or onto a small screen. When <b>ECO</b> is selected, the amount of electricity consumed and the fan rotation noise during projection are reduced, and the lamp's operating life is extended.</p> <p><b>Normal 2:</b> Adjusts the brightness automatically according to the surrounding environment.</p>
<b>Remote Receiver</b>	<p>You can limit the reception of the operation signal from the remote control.</p> <p>When you want to prohibit operation by remote control, or if the remote receiver has a fluorescent light too close to it, you can make settings to deactivate the remote receiver you do not want to use or that is experiencing interference.</p> <p>If the [Menu] button on the remote control is pressed for 15 seconds, this parameter will return to the default setting.</p>
<b>User Button</b>	<p>You can assign selected items from the configuration menu to the remote control's [User] button. By pressing the [User] button, the assigned menu item selection/adjustment screen is displayed, allowing you to make one-touch settings/adjustments. You can assign one of the following items to the [User] button.</p> <p><b>Power Consumption</b>*, <b>Info</b>, <b>Progressive</b>, <b>Test Pattern</b>, <b>Multi-screen</b>, <b>Resolution</b>, <b>Memory</b></p>
<b>Test Pattern</b>	<p>When the projector is setup, a Test Pattern is displayed so that you can adjust the projection without connecting other equipment.</p> <p> <a href="#">p.159</a></p>
<b>Memory</b>	<p><b>Load Memory:</b> Recalls the settings saved in <b>Save Memory</b>.  <a href="#">p.52</a></p> <p>You cannot select if nothing is registered by <b>Save Memory</b>.</p> <p><b>Save Memory:</b> Saves image related settings in the configuration menu to memory.  <a href="#">p.51</a></p> <p><b>Erase Memory:</b> Deletes unnecessary memories.  <a href="#">p.52</a></p> <p><b>Rename Memory:</b> Changes the name of the saved memory.  <a href="#">p.52</a></p>
<b>Reset</b>	<p>You can reset all adjustment values on the <b>Settings</b> menu to their default settings, except for <b>User Button</b> and <b>Memory</b>.</p> <p>To return all menu items to their default settings, see  <a href="#">p.91</a></p>





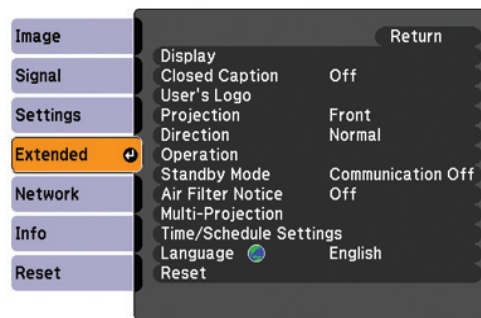

\* Not available on PowerLite Pro Z8150NL

## Extended Menu



Sub Menu	Function
<b>Display</b>	<p>You can make settings related to the projector's display.</p> <p><b>Menu Position:</b> Select the position to display the menu on the projected screen.</p> <p><b>Messages:</b> The following messages are not displayed on the screen when this item is set to <b>Off</b>. Overheating and other warnings, messages such as when there is no video input, and when Freeze is On or when changing Source, Color Mode or Aspect.</p> <p><b>Display Background<sup>*1</sup>:</b> You can set the screen status for when there is no video input to <b>Black, Blue, or Logo</b>.</p> <p><b>Startup Screen<sup>*1</sup>:</b> Set this parameter to <b>On</b> to display the user's logo when projection is started.</p> <p><b>Panel Alignment:</b> Correct color misalignments (red and blue) in the screen.</p>
<b>Closed Caption</b>	You can select <b>CC1, CC2, or Off</b> .
<b>User's Logo<sup>*1</sup></b>	You can change the User's Logo that is displayed as a background during Display Background or Startup Screen. 🖱️ <a href="#">p.43</a>
<b>Projection</b>	Set this parameter according to the way the projector is installed. 🖱️ <a href="#">p.152</a>
<b>Direction</b>	Set this parameter according to the way the projector is installed. 🖱️ <a href="#">p.152</a>

Sub Menu	Function
<p><b>Operation</b></p>	<p><b>Direct Power On:</b> You can set whether or not (<b>On/Off</b>) to enable Direct Power On. Be careful when this item is set to <b>On</b> because this unit turns on at the time of power recovery with this unit plugged-in to an outlet.</p> <p><b>Sleep Mode:</b> When set to <b>On</b>, this automatically stops projection when no image signal is being input and no operations are carried out.</p> <p><b>Sleep Mode Timer:</b> When <b>Sleep Mode</b> is set to <b>On</b>, you can set the time before the projector automatically turns off within a range of 1 to 30 minutes.</p> <p><b>Shutter Button:</b> Select an operation to be done when the [<b>Shutter</b>] button is pressed. When <b>Electric Shutter</b> is selected, the electric shutter opens/closes.  p.39 When <b>Blank</b> is selected, this turns off the video temporarily.</p> <p><b>Shutter Timer:</b> When set to <b>On</b>, this turns off the power automatically 120 minutes after the electric shutter is closed.</p> <p><b>Shutter Timer</b> is set to <b>On</b> at the time of purchase. (When Shutter Timer and Sleep Mode are set to <b>On</b> at the same time, Sleep Mode has priority.)</p> <p><b>High Altitude Mode:</b> Set to <b>On</b> when using the projector above an altitude of 4921 ft (1500 m).</p> <p><b>BNC Sync Termination:</b> Set the termination for the signal from the BNC input port. This should usually be set to <b>Off</b>. Set to <b>On</b> when analog (75Ω) termination such as for switchers is necessary.</p> <p><b>Remote Control Type:</b> You can select <b>Normal</b> or <b>Simple</b> depending on the type of remote control. Set this item to <b>Normal</b> to use the remote control provided with the projector. When <b>Simple</b> is selected, you can use the remote control provided with other Epson projectors to operate this projector. This is useful if you want to use a remote control that you are already familiar with to operate the projector. However, you cannot use the remote control provided with this projector if this is set to <b>Simple</b>. Make sure that the setting is correct because, if the projector is mounted on the ceiling or somewhere hard to reach, changing it back to <b>Normal</b> may be difficult. Additionally, you cannot use the functions that are not equipped with this projector or the remote control which you use.</p> <p><b>Beep:</b> When this is set to <b>On</b>, the confirmation buzzer beeps to notify you that the power turns on or off, the electric shutter opens or closes, or the cooling down is finished.</p>
<p><b>Standby Mode</b></p>	<p>You can use the functions that monitor and control the status of the projector over the network even when the projector is in standby mode if this is set to <b>Communication On</b>.</p>
<p><b>Air Filter Notice</b></p>	<p>You can set whether or not (<b>On/Off</b>) to enable the Air Filter Notice. When this is set to <b>On</b> and a clog in the air filter is detected, the message is displayed on the screen.</p>

Sub Menu	Function
<b>Multi-Projection</b>	<p>You can adjust the settings when projecting images from multiple projectors.  <a href="#">p.175</a></p> <p><b>Brightness Level</b> (not available on PowerLite Pro Z8150NL): Set the lamp brightness level between 1 and 5. This item can be adjusted when <b>Normal 1</b> is selected in the <b>Power Consumption</b> setting from the <b>Settings</b> menu.</p> <p><b>Edge Blending</b>: Corrects a border between multiple images to create a seamless screen.  <a href="#">p.180</a></p> <p><b>Multi-screen</b>: You can adjust the hue and brightness of each projected image.  <a href="#">p.182</a></p> <p><b>Projector ID</b>: Set the ID within a range of 1 to 9. <b>Off</b> indicates that no ID is set.  <a href="#">p.175</a></p>
<b>Time/Schedule Settings</b>	Displays the screen to set the current time and schedules.  <a href="#">p.185</a>
<b>Language</b>	You can set the Language for message displays.
<b>Reset</b>	<p>You can reset <b>Display</b><sup>*2</sup>, <b>Operation</b><sup>*3</sup>, <b>Air Filter Notice</b>, and <b>Multi-Projection</b><sup>*4</sup> from the <b>Extended</b> menu to their default settings.</p> <p>To return all menu items to their default settings, see  <a href="#">p.91</a></p>

\*1 When **User's Logo Protect** is set to **On** in **Password Protect**, settings relating to User's Logo cannot be changed. You can make changes after setting **User's Logo Protect** to **Off**.  [p.45](#)

\*2 Except for parameters related to the user's logo

\*3 Except for **High Altitude Mode** and **Remote Control Type**

\*4 Except for **Multi-screen** and **Projector ID**

## Network Menu

When **Network Protect** is set to **On** in **Password Protect**, a message is displayed and the settings cannot be changed. You can make changes after setting **Network Protect** to **Off**.  [p.45](#)

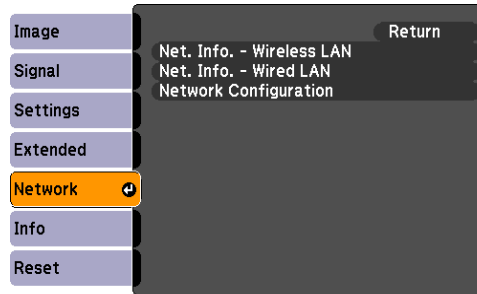

Sub Menu	Function
<b>Net. Info. - Wireless LAN</b> <b>Net. Info. - Wired LAN</b>	Displays the network settings.
<b>Network Configuration</b>	Displays the screen to set the network.  <a href="#">p.71</a>



By using the Web browser of a computer connected to the projector on a network, you can set the projector's functions and control the projector. This function is called "Web Control". You can easily enter text using a keyboard to make settings for "Web Control" such as security settings.  [p.129](#)

## Notes on Operating the Network Menu

Selecting from the top menu and sub menus, and changing of selected items are the same as operations in the configuration menu.

When done, make sure you go to the **Setup complete**, and select **Yes**, **No**, or **Cancel**. When you select **Yes** or **No**, you return to the configuration menu.

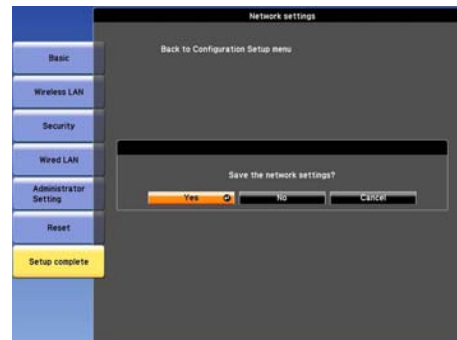

**Yes:** Saves the settings and exits the **Network** menu.

**No:** Exits to the **Network** menu without saving the settings.

**Cancel:** Continues displaying the **Network** menu.



If the settings contain an invalid value, the settings may not take effect, even after you select **Yes**.

## Soft Keyboard Operations

The **Network** menu contains items that require input of alphanumerics during setup. In this case, the following software keyboard is displayed. Use the [⊙] button on the remote control or [↖/▲], [↘/▼], [↙/◀], and [↗/▶] on the projector to move the cursor to the desired key, and then press the [Enter] button to enter the alphanumeric. Enter figures by holding down the [Num] button on the remote control, and pressing the numeric buttons. After inputting, press [Finish] on the keyboard to confirm your input. Press [Cancel] on the keyboard to cancel your input.



- Each time the [CAPS] key is selected and the [Enter] button is pressed, it switches between uppercase and lowercase letters.
- Each time the [SYM1/2] key is selected and the [Enter] button is pressed, it switches the symbol keys in the section enclosed in the box.



## Basic Menu











Sub Menu	Function
<b>Projector Name</b>	Displays the projector name used to identify the projector when connected to a network. When editing, you can enter up to 16 single-byte alphanumeric characters.
<b>Web Remote Password</b>	Set a password to use Web Remote. You can enter up to 8 single-byte alphanumeric characters. Web Remote is a computer function that allows you to operate the projector by using the Web browser on a computer connected on a network. <a href="#">p.129</a>
<b>Projector Keyword</b>	When set to <b>On</b> , you have to enter the keyword when you try to connect the projector to a computer using EasyMP Multi PC Projection and EasyMP Network Projection. As a result, you can prevent presentations from being interrupted by unscheduled connections from the computer. Normally this should be set to <b>On</b> .

## Wireless LAN Menu

To connect the projector to a computer using a wireless LAN, install the Wireless LAN unit (V12H418P12).  [p.192](#)



Sub Menu	Function
<b>Wireless LAN Power</b>	Set this parameter to <b>On</b> when connecting the projector and a computer via a wireless LAN. If you do not want to connect via a wireless LAN, set this parameter to <b>Off</b> to prevent unauthorized access by others.
<b>Wi-Fi Protected Setup</b>	When using a <u>WPS (Wi-Fi Protected Setup)</u>  compatible access point via a wireless LAN, you can easily connect the projector to the access point and make security settings.  <a href="#">p.146</a>
<b>Wireless LAN system</b>	Sets the wireless LAN system. Normally this should be set to <b>802.11b/g/n</b> . The connection method is selected automatically according to the access point settings. In an area that does not support 802.11n, only <b>802.11b/g</b> is displayed.
<b>Connection Mode</b>	Set the connection mode to use when connecting the projector and a computer via a wireless LAN. If you select <b>Quick</b> , a small network is created automatically by the projector and computer. It is used with EasyMP Network Projection. If <b>SSID Auto Setting</b> is <b>On</b> , the projector becomes an access point. If it is set to <b>Off</b> , the network is created in <u>Ad hoc mode</u>  . If you select <b>Advanced</b> , the connection is established by the installed access point and <u>Infrastructure mode</u>  .
<b>SSID Auto Setting</b>	If <b>Connection Mode</b> is set to <b>Quick</b> , when you set this to <b>On</b> , you can search for the projector more quickly from among multiple projectors. SSID is set automatically. When connecting to multiple projectors from 1 computer in Quick mode, set this to <b>Off</b> , and set the same SSID in all the projectors that will connect.



Sub Menu	Function
<b>SSID</b>	Enter an SSID. When an SSID is provided for the wireless WLAN network in which the projector participates, enter the SSID. You can enter up to 32 single-byte alphanumeric characters.
<b>Search Access Point</b>	When <b>Connection Mode</b> is set to <b>Advanced</b> , you can search for surrounding access points, and set the SSID to be connected from those access points. Depending on the access point settings, they may not be displayed in the list. You must set security separately.  p.76
<b>Channel</b>	You can select the channels used to connect in Quick mode. If interference from other signals occurs, use a different channel.
<b>SSID Display</b>	To prevent the SSID from being displayed on the LAN Standby screen, set this to <b>Off</b> .
<b>DHCP</b>	You can set whether or not ( <b>On/Off</b> ) to use <u>DHCP</u>  . If this is set to <b>On</b> you cannot set any more addresses.
<b>IP Address</b>	You can input the <u>IP address</u>  assigned to the projector. You can input a number from 0 to 255 in each field of the address. However, the following IP addresses cannot be used. 0.0.0.0, 127.x.x.x, 224.0.0.0 to 255.255.255.255 (where x is a number from 0 to 255)
<b>Subnet Mask</b>	You can input the <u>Subnet Mask</u>  for the projector. You can input a number from 0 to 255 in each field of the address. However, the following subnet masks cannot be used. 0.0.0.0, 255.255.255.255
<b>Gateway Address</b>	You can input the IP address for the gateway for the projector. You can input a number from 0 to 255 in each field of the address. However, the following <u>Gateway addresses</u>  cannot be used. 0.0.0.0, 127.x.x.x, 224.0.0.0 to 255.255.255.255 (where x is a number from 0 to 255)
<b>IP Address Display</b>	To prevent the IP address from being displayed on the LAN Standby screen, set this to <b>Off</b> .
<b>Region Code</b>	This is a specific string of the wireless LAN module.

## Search Access Point screen

Detected access points are displayed in a list.

Access points using WEP encryption cannot be connected to because this projector does not support the WEP encryption method.



Sub Menu/Icon	Function
<b>Refresh</b>	Starts detecting access points again.
	Indicates an already set access point.
	Indicates the access points where security is enabled. If you select an access point without security enabled, the Wireless LAN menu appears. If you select an access point which has security enabled, the Security menu appears. Set security according to the access point settings.

## Security Menu (Only Available when the Optional Wireless LAN Unit Is Installed)

When the Wireless LAN unit is installed, it is strongly recommended that you set security.



Sub Menu	Function
<p><b>Security</b></p>	<p>You can select a type of security.</p> <p><b>When Quick is selected</b></p> <p><b>Open:</b> Security is not set.</p> <p><b>WPA/WPA2-PSK</b> (only when <b>SSID Auto Setting</b> is <b>On</b>): Communication takes place using security by WPA2. Uses AES method for encryption. When establishing connection from computer to projector, enter the value set in the passphrase.</p> <p><b>When Advanced is selected</b></p> <p><b>Open:</b> Connects to access points without security enabled.</p> <p><b>WPA/WPA2-PSK:</b> Connects in WPA personal mode. Encryption method is selected automatically according to the access point settings. Set a passphrase which is the same for the access point.</p> <p><b>WPA/WPA2-EAP:</b> Connects in WPA enterprise mode. Encryption method is selected automatically according to the access point settings. Also select this item when using LEAP.</p>



You cannot set WEP as an encryption method for this projector.

## When WPA/WPA2-PSK is selected



Sub Menu	Function
<p><b>Passphrase</b></p>	<p>You can enter at least 8 and up to 63 single-byte alphanumeric characters for the passphrase. When the passphrase is entered and the [Enter] button is pressed, the value is set and displayed as an asterisk (*).</p> <p>When using it with EasyMP Network Projection, you do not need to input the passphrase in the computer if it is the initial (default) passphrase.</p> <p>It is recommended to change the passphrase periodically for security reasons. If the network settings are initialized, it returns to the initial passphrase. 🖱️ <a href="#">p.88</a></p> <p>You cannot enter more than 32 characters on the configuration menu. When setting from Web Control, you can enter more than 32 characters. 🖱️ <a href="#">p.129</a></p> <p>In Quick mode, the initial passphrase is set.</p>

## When WPA/WPA2-EAP is selected

PEAP/EAP-Fast



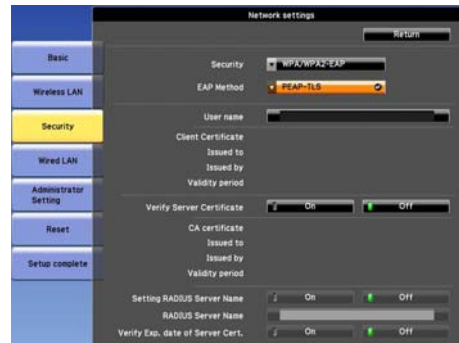

PEAP-TLS/EAP-TLS



LEAP



Sub Menu	Function
<p><b>EAP Method</b></p>	<p>Set the protocol for authentication.</p> <p><b>PEAP:</b> Authentication protocol widely used in Windows Server.</p> <p><b>PEAP-TLS:</b> Authentication protocol used in Windows Server. Set when using client certificate.</p> <p><b>EAP-TLS:</b> Authentication protocol widely used for user authentication.</p> <p><b>EAP-Fast, LEAP:</b> Select this when these authentication protocols are used.</p>
<p><b>User name</b></p>	<p>You can enter a user name to be used for authentication in single-byte alphanumeric characters (no spaces). You can enter up to 64 characters.</p> <p>If you select PEAP-TLS or EAP-TLS, the user name obtained automatically from the client certificate is displayed. You can change the user name, if the authentication server requires another user name.</p> <p>You cannot enter more than 32 characters on the configuration menu. When setting from Web Control, you can enter more than 32 characters.</p> <p> <a href="#">p.129</a></p> <p>If you must also enter the domain name, add the domain name before user name separated by a backslash.</p>

Sub Menu	Function
<b>Password</b>	<p>You can enter an authentication password in single-byte alphanumeric characters. You can enter up to 64 characters. When the password is entered and the [Enter] button is pressed, the value is set and displayed as an asterisk (*).</p> <p>You cannot enter more than 32 characters on the configuration menu. When setting from Web Control, you can enter more than 32 characters.</p> <p> <a href="#">p.129</a></p>
<b>Client Certificate</b>	<p><b>Issued to/Issued by/Validity period</b></p> <p>Displays the information set in the stored client certificate. It is blank if the certificate is not set.</p>
<b>Verify Server Certificate</b>	<p>Set whether or not to verify with the authentication server certificate to prevent illegal authentication. To select <b>On</b>, you must set a CA certificate that can verify the authentication server certificate.  <a href="#">p.131</a></p>
<b>CA certificate</b>	<p><b>Issued to/Issued by/Validity period</b></p> <p>Displays the information set in the stored CA certificate. It is blank if the certificate is not set.</p>
<b>Setting RADIUS Server Name</b>	<p>Set whether or not to verify the authentication server name during server certificate verification. If you set this to <b>On</b> and specify the server name, you reduce the risk of connecting to an invalid authentication server.</p>
<b>RADIUS Server Name</b>	<p>Specify the authentication server name.</p> <p>You can enter up to 32 single-byte alphanumeric characters.</p>
<b>Verify Exp. date of Server Cert.</b>	<p>Set whether or not to verify the expiration date of the certificate during server certificate verification. If <b>On</b> is selected, the validity of the authentication server certificate is verified from the internal time of the projector.</p>



## Wired LAN Menu



Sub Menu	Function
<b>DHCP</b>	You can set whether or not ( <b>On/Off</b> ) to use <u>DHCP</u> ▶▶. If this is set to <b>On</b> you cannot set any static IP addresses.
<b>IP Address</b>	You can input the <u>IP address</u> ▶ assigned to the projector. You can input a number from 0 to 255 in each field of the address. However, the following IP addresses cannot be used. 0.0.0.0, 127.x.x.x, 224.0.0.0 to 255.255.255.255 (where x is a number from 0 to 255)
<b>Subnet Mask</b>	You can input the <u>Subnet Mask</u> ▶▶ for the projector. You can input a number from 0 to 255 in each field of the address. However, the following subnet masks cannot be used. 0.0.0.0, 255.255.255.255
<b>Gateway Address</b>	You can input the IP address for the gateway for the projector. You can input a number from 0 to 255 in each field of the address. However, the following <u>Gateway addresses</u> ▶▶ cannot be used. 0.0.0.0, 127.x.x.x, 224.0.0.0 to 255.255.255.255 (where x is a number from 0 to 255)
<b>IP Address Display</b>	To prevent the IP address from being displayed on the LAN Standby screen, set this to <b>Off</b> .

## Administrator Settings Menu



Sub Menu	Function
<b>Administrator Password</b>	This is the password for the Administrator settings menu of network settings. You can enter up to 16 single-byte alphanumeric characters. If the administrator password is not set, click <b>OK</b> with an empty password box.
<b>Network Host Name</b>	You can enter up to 15 single-byte alphanumeric characters.
<b>PJLink Password</b>	Set a password to use when you access the projector using compatible PJLink software. 🖱️ <a href="#">p.137</a> You can enter up to 32 single-byte alphanumeric characters.
<b>Web Control Password</b>	Set a password to use when making settings and controlling the projector using Web Control. You can enter up to 8 single-byte alphanumeric characters. Web Control is a computer function that allows you to set up and control the projector by using the Web browser on a computer connected on a network. 🖱️ <a href="#">p.129</a>
<b>Monitor Password</b>	You can enter up to 16 single-byte alphanumeric characters.
<b>Secure HTTP</b>	Apply security (HTTPS) to Web Control. To set security by Web control, it is recommended to set it <b>On</b> .
<b>Mail Notification</b>	Goes to the Mail Notification setting menu. 🖱️ <a href="#">p.84</a>
<b>Manage Certificates</b>	Goes to the Manage Certificates settings menu. 🖱️ <a href="#">p.85</a>
<b>SNMP</b>	Goes to the SNMP settings menu. 🖱️ <a href="#">p.87</a>
<b>Priority Gateway</b>	For the priority gateway, select either <b>Wired</b> or <b>Wireless</b> .

Sub Menu	Function
<b>AMX Device Discovery</b>	When the projector is connected to a network, set this to <b>On</b> to allow the projector to be detected by <a href="#">AMX Device Discovery</a> . Set this to <b>Off</b> if you are not connected to an environment controlled with a controller from AMX or AMX Device Discovery.
<b>Crestron RoomView</b>	Set this parameter to <b>On</b> only when using Crestron RoomView® to monitor and control the projector over a network. Normally, leave this parameter set to <b>Off</b> .  "About Crestron RoomView®" p.138 Changes in projector settings take effect upon restarting. The following functions cannot be used when it is set to <b>On</b> . <ul style="list-style-type: none"> <li>• Web Control</li> <li>• Message Broadcasting (EasyMP Monitor plugin)</li> </ul>
<b>Bonjour</b>	To connect to the network by Bonjour, set it to <b>On</b> . For an explanation of the Bonjour service, see the Apple Web site. <a href="http://www.apple.com/">http://www.apple.com/</a>
<b>EPSON Message Broadcasting</b>	You can switch the EPSON Message Broadcasting function to enable or disable. Download the software and the User's Guide from the following website. <a href="http://www.epson.com">http://www.epson.com</a> You can download Message Broadcasting and its Operation Guide from the following Web site. <a href="http://www.epson.com">http://www.epson.com</a>

## Mail Notification menu

When this is set, you receive an e-mail notification if a problem or warning occurs in the projector. 🖱️ "Reading Problem Mail Notification Function" p.133

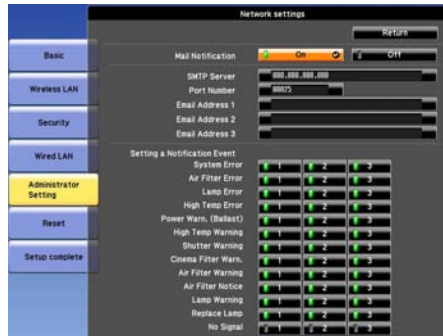

Sub Menu	Function
<b>Mail Notification</b>	You can set whether or not ( <b>On/Off</b> ) to be notified by e-mail.
<b>SMTP Server</b>	You can input the <u>IP address</u> ▶ for the SMTP server for the projector. You can input a number from 0 to 255 in each field of the address. However, the following IP addresses cannot be used. 127.x.x.x, 224.0.0.0 to 255.255.255.255 (where x is a number from 0 to 255)
<b>Port Number</b>	You can input the port number for the SMTP server. The default value is 25. You can input numbers between 1 to 65535.
<b>Email Address 1/Email Address 2/Email Address 3</b>	You can input the e-mail address of the destination to send the notification e-mail to. You can register up to three destinations. You can enter up to 64 single-byte alphanumeric characters for the e-mail addresses. You cannot enter more than 32 characters on the configuration menu. When setting from Web Control, you can enter more than 32 characters. 🖱️ p.129
<b>Setting a Notification Event</b>	You can select the problems or warnings to be notified about by e-mail. When the selected problem or warning occurs in the projector, an e-mail is sent to the specified <b>Email Address</b> notifying that a problem or warning has occurred. You can select multiple items from the displayed items. Sender is Email Address 1.

## Manage Certificates menu



Sub Menu	Function
<p><b>Client Certificate</b></p>	<p><b>Issued to/Issued by/Validity period</b>                      Displays the information set in the stored client certificate. It is blank if the certificate is not set. You must set the certificate if you use <b>PEAP-TLS</b> and <b>EAP-TLS</b>.                      Select <b>Clear</b> to delete the stored certificate.</p>
<p><b>CA certificate</b></p>	<p><b>Issued to/Issued by/Validity period</b>                      Displays the information set in the stored CA certificate. It is blank if the certificate is not set. You must set the certificate if you use <b>EAP</b> to authenticate the authentication server certificate.                      Select <b>Clear</b> to delete the stored certificate.</p>
<p><b>Self-signed Certificate</b></p>	<p><b>Issued to/Issued by/Validity period</b>                      When <b>Secure HTTP</b> is set to <b>On</b>, information on the certificate maintained by the server function in the projector is displayed. It is not displayed if Web Server Certificate is set.                      Select <b>Refresh</b> to update the self-signed certificate.</p>
<p><b>Web Server Certificate</b></p>	<p><b>Issued to/Issued by/Validity period</b>                      Displays information on the certificates set in the projector, which are needed when <b>Secure HTTP</b> is set to <b>On</b>. It is not displayed if Self-signed Certificate is set.                      Select <b>Clear</b> to delete the stored certificate.</p>



Web Control is used to set certificates. 🖱️ "Setting Certificates" [p.131](#)

## SNMP menu

To use SNMP to monitor the projector, you need to install the SNMP manager program on your computer. SNMP should be managed by a network administrator.



Sub Menu	Function
<b>SNMP</b>	Set this parameter to <b>On</b> when using <a href="#">SNMP</a> to monitor the projector.
<b>Trap IP Address 1/Trap IP Address 2</b>	When <b>SNMP</b> is set to <b>On</b> , you can set up to two IP addresses as SNMP trap notification destinations. You can input a number from 0 to 255 in each field of the address. However, the following IP addresses cannot be used. 127.x.x.x, 224.0.0.0 to 255.255.255.255 (where x is a number from 0 to 255)
<b>Community Name</b>	Set the community name of SNMP. You can enter up to 32 single-byte alphanumeric characters.

## Reset Menu

Resets all of the network settings.

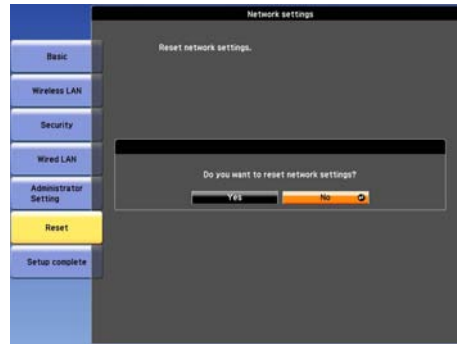

Sub Menu	Function
<p><b>Reset network settings.</b></p>	<p>To reset all of the network settings, select <b>Yes</b>.</p> <p>When you reset the network settings, the Passphrase, Administrator Password and Manage Certificates menu settings change back to their default values, and the certificates are deleted.</p> <p>After you reset all the settings, the <b>Basic</b> menu appears.</p>



## Info Menu (Display Only)

Lets you check the status of the image signals being projected and the status of the projector. Items that can be displayed vary depending on the image signal or input source being projected as shown in the following screen shots.

### RGB Signal/Component Video▶▶ Signal

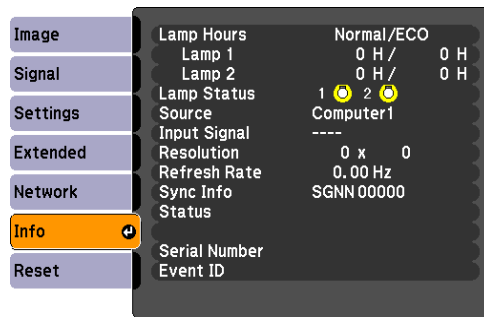



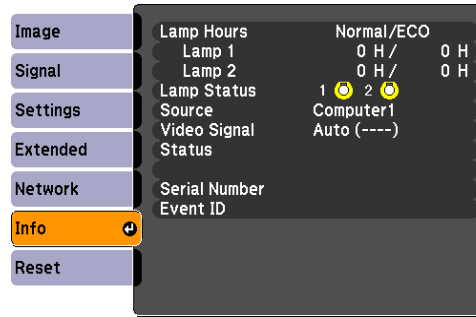

### Composite video▶▶ Signal/S-Video▶▶ Signal

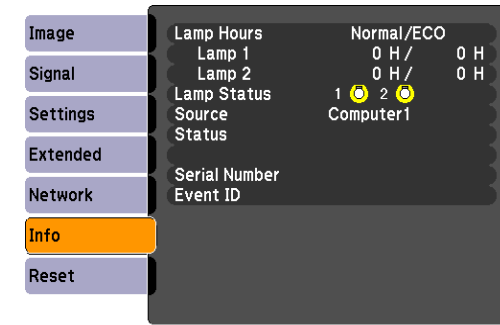

### LAN



Sub Menu	Function
<b>Lamp Hours</b>	You can display the cumulative lamp operating time * . When it reaches the lamp warning time, the characters are displayed in yellow.
<b>Lamp Status</b>	The following icons show the status of the lamps.  : Lighted  : Disable When  is displayed, the lamp is not operating normally. See "Reading the Indicators".  p.96
<b>Source</b>	You can display the Source name for the connected equipment currently being projected.
<b>Input Signal</b>	You can display the <b>Input Signal</b> selected in the <b>Signal</b> menu.
<b>Resolution</b>	You can display the Resolution.
<b>Video Signal</b>	You can display the <b>Video Signal</b> selected in the <b>Signal</b> menu.
<b>Refresh Rate</b>	You can display the <u>Refresh Rate</u> ▶▶.
<b>Sync Info</b>	You can display the image signal information. This information may be needed if service is required.

Sub Menu	Function
<b>Status</b>	This is information about errors that have occurred on the projector. This information may be needed if service is required.
<b>Serial Number</b>	Displays the projector's serial number.
<b>Event ID</b>	When problems occur when the projector and computer are connected through the network, information on the problem is displayed using an Event ID. Refer to the following page for information on interpreting the Event ID.  <a href="#">p.112</a>

\* The cumulative use time is displayed as "0H" for the first 10 hours. 10 hours and above is displayed as "10H", "11H", etc. If you are using PowerLite Pro Z8250NL/Z8255NL/Z8350WNL/Z8450WUNL/Z8455WUNL, the lamp operating times of both power consumption mode and normal mode are displayed.

## Reset Menu

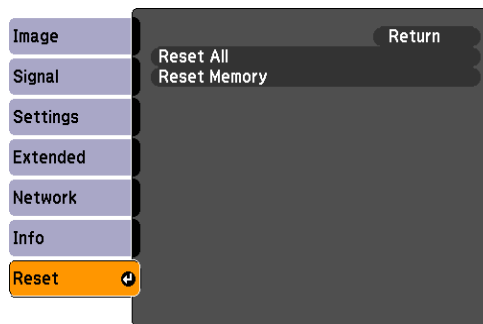

Sub Menu	Function
<b>Reset All</b>	You can reset all items in the configuration menu to their default settings. The following items are not reset to their defaults: passwords, <b>Input Signal</b> , <b>Memory</b> , <b>User's Logo</b> , <b>Multi-screen</b> , all items for <b>Network</b> menus, <b>Lamp Hours</b> , and <b>Language</b> .
<b>Reset Memory</b>	Resets items for <b>Memory</b> in the <b>Settings</b> menu.

# Troubleshooting

This chapter explains how to identify problems and what to do if a problem is found.

## Using the Help

If a problem occurs with the projector, press the [Help] button. You can solve problems by answering the questions.

### Procedure

- 1 Press the [Help] button.

The Help screen is displayed.

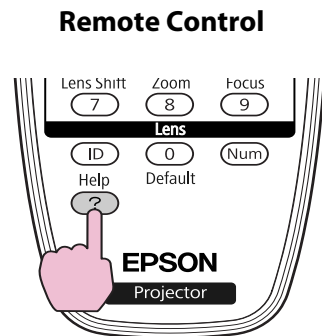

- 2 Select a menu item.

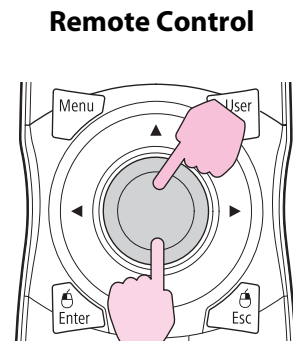
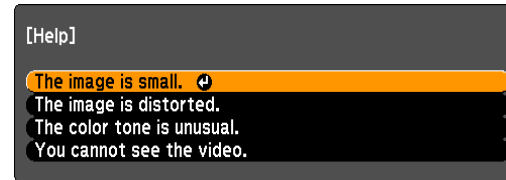

**3** Confirm the selection.

**Remote Control**

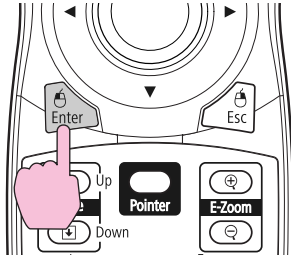

Questions and solutions are displayed as shown on the screen below.

Press the [Help] button to exit Help.

**The image is small.**

- Is zoom set to minimum?  
·Use the zoom ring to change the size of the image.
- Is the projector too close to the screen?  
·Move the projector away from the screen.



If the Help screen does not provide a solution to the problem, refer to "Problem Solving" [p.95](#).

## Problem Solving

If you are having a problem with the projector, first check the projector's indicators and refer to "Reading the Indicators". 🖱️ [p.96](#)

If the indicators do not show clearly what the problem might be, refer to "When the Indicators Provide No Help". 🖱️ [p.101](#)

## Reading the Indicators

These indicators indicate the operating status of the projector.

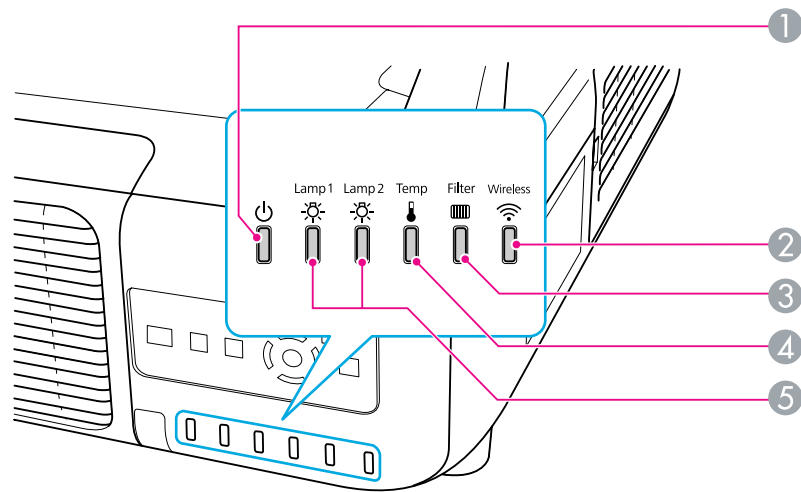

❶ Indicates the operating status.

■ Standby condition

When the [⏻] button is pressed in this condition, projection starts.



Preparing network monitoring (maximum approx. 20 seconds) or cool down in progress

Buttons are disabled while the indicator is flashing.



Warming up

Warm-up time is about 30 seconds. After warm-up is complete, the indicator stops flashing.

[⏻] button does not function during warm-up.



Projecting

❷ Indicates the operating status of wireless LAN when the optional wireless LAN unit is connected.

❸ Indicates the air filter status.

❹ Indicates the internal temperature status.

















































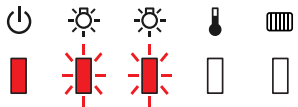

- 5 Indicates the projection lamps status.  
Flashes green while Shutter or Blank is activated.

Refer to the following table to see what the indicators mean and how to remedy problems that they indicate. If all indicators are off, check that the power cable is connected correctly and that the power is being supplied normally. Sometimes, when the power cable is unplugged, the ⏻ indicator remains lit for a short period, but this is not a malfunction.

## ⏻ Indicator is lit or flashing red



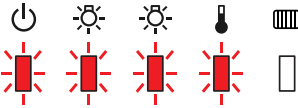



































 : Lit  : Flashing:  : Off









Status	Cause	Remedy or Status
         	Internal Error	Stop using the projector, disconnect the power cable from the electrical outlet, and contact Epson.  <a href="#">p.114</a>
         	Fan Error Sensor Error Cool System Error	Stop using the projector, disconnect the power cable from the electrical outlet, and contact Epson.  <a href="#">p.114</a>
         	High Temp Error (overheating)	<p>The lamps turn off automatically and projection stops. Wait for about five minutes. After about five minutes the projector switches to standby mode, so check the following two points.</p> <ul style="list-style-type: none"> <li>• Check that the air filter and air exhaust vent are clear, and that the projector is not positioned against a wall.</li> <li>• If the air filter is clogged, clean or replace it.  <a href="#">p.116</a>, <a href="#">p.122</a></li> </ul> <p>If the error continues after checking the points above, stop using the projector, disconnect the power cable from the electrical outlet, and contact Epson.  <a href="#">p.114</a></p> <p>When using at an altitude of 4621 ft (1500 m) or more, set <b>High Altitude Mode</b> to <b>On</b>.  <a href="#">p.67</a></p> <p>Set <b>Direction</b> to <b>Pointing Down</b>, <b>Pointing Up</b>, <b>Angled Up</b>, or <b>Angled Down</b> when the projector is installed in a direction which is not horizontal.  <a href="#">p.67</a></p>

Status	Cause	Remedy or Status
	<p>Lamp Error Lamp Failure</p>	<p>Check the following two points.</p> <ul style="list-style-type: none"> <li>• Take out both lamps and check if they are cracked.  <a href="#">p.119</a></li> <li>• Clean the air filter.  <a href="#">p.116</a></li> </ul> <p><b>If it is not cracked:</b> Re-fit the lamp and turn on the power.</p> <p><b>If the error continues:</b> Replace the lamp with a new lamp and turn on the power.</p> <p><b>If the error continues:</b> Stop using the projector, disconnect the power cable from the electrical outlet, and contact Epson.  <a href="#">p.114</a></p> <p><b>If it is cracked:</b> Replace it with a new lamp, or contact Epson for further advice. If replacing the lamp yourself, be careful to avoid pieces of broken glass (you cannot continue projecting until the lamp is replaced).  <a href="#">p.114</a></p> <p>When using at an altitude of 4921 ft (1500 m) or more, set <b>High Altitude Mode</b> to <b>On</b>.  <a href="#">p.67</a></p> <p>Set <b>Direction</b> to <b>Pointing Down, Pointing Up, Angled Up, or Angled Down</b> when the projector is installed in a direction which is not horizontal.  <a href="#">p.67</a></p>
	<p>Filter Airflow Error</p>	<p>Check the following two points.</p> <ul style="list-style-type: none"> <li>• Check that the air filter and air exhaust vent are clear, and that the projector is not positioned against a wall.</li> <li>• If the air filter is clogged, clean or replace it.  <a href="#">p.116, p.122</a></li> </ul> <p>If the error continues after checking the points above, stop using the projector, disconnect the power cable from the electrical outlet, and contact Epson.  <a href="#">p.114</a></p>
	<p>Auto Iris Error Cinema filter error Shutter Error Power Err. (Ballast)</p>	<p>Stop using the projector, disconnect the power cable from the electrical outlet, and contact Epson.  <a href="#">p.114</a></p>

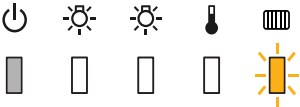

## Indicator is flashing or lit

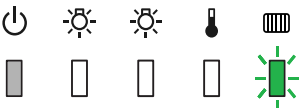
 : Lit 
  : Flashing 
  : Off 
  : Varies according to the projector status

Status	Cause	Remedy or Status
         	High Temp Warning	(This is not an abnormality. However, if the temperature rises too high again, projection stops automatically.) <ul style="list-style-type: none"> <li>• Check that the air filter and air exhaust vent are clear, and that the projector is not positioned against a wall.</li> <li>• If the air filter is clogged, clean or replace it.  <a href="#">p.116</a>, <a href="#">p.122</a></li> </ul>
         	Replace Lamp	The lamp indicated by flashing indicator, lamp 1 or 2, is due for replacement. Replace it with a new lamp.  <a href="#">p.119</a>  If you continue to use the lamp after the replacement period has passed, the possibility that the lamp may explode increases. Replace it with a new lamp as soon as possible.  We recommend replacing both lamps together to maintain consistent hue and brightness of projected images.
         	Lamp Warning Supply System Warning (Ballast)	Check the following two points. <ul style="list-style-type: none"> <li>• Remove the lamp indicated by the flashing indicator, lamp 1 or 2, and check if it is cracked.  <a href="#">p.119</a></li> <li>• Clean the air filter.  <a href="#">p.116</a></li> </ul> <p><b>If it is not cracked:</b> Re-fit the lamp and turn on the power.</p> <p><b>If the error continues:</b> Replace the lamp with a new lamp and turn on the power.</p> <p><b>If the error continues:</b> Stop using the projector, disconnect the power cable from the electrical outlet, and contact Epson.  <a href="#">p.114</a></p> <p><b>If it is cracked:</b> Replace it with a new lamp, or contact Epson. (Only one lamp is working. Replace the burned-out lamp as soon as possible.).  <a href="#">p.114</a></p> <p>If replacing the lamp yourself, be careful to avoid pieces of broken glass.</p> <p>When using at an altitude of 4921 ft (1500 m) or more, set <b>High Altitude Mode to On</b>.  <a href="#">p.67</a></p> <p>Set <b>Direction to Pointing Down, Pointing Up, Angled Up, or Angled Down</b> when the projector is installed in a direction which is not horizontal.  <a href="#">p.67</a></p>

Status	Cause	Remedy or Status
	No Air Filter Air Flow Sensor Err.	<p>Check that the air filter is securely installed.  <a href="#">p.122</a></p> <p>The projector automatically turns off about one minute after it detects that there is no air filter.</p> <p>If the error continues even though an air filter is installed, the air filter sensor may be defective. Stop using the projector, disconnect the power cable from the electrical outlet, and contact Epson.  <a href="#">p.114</a></p>
	Low Air Flow	<p>(This is not an abnormality. However, projection stops automatically if the airflow falls any further.)</p> <p>The message "The air filter is clogged. Clean or replace the air filter." is displayed. Check the following two points.</p> <ul style="list-style-type: none"> <li>• Check that the air filter and air exhaust vent are clear, and that the projector is not positioned against a wall.</li> <li>• If the air filter is clogged, clean or replace it.  <a href="#">p.116</a>, <a href="#">p.122</a></li> </ul> <p>If the Low Air Flow status continues after cleaning the air filter, replace the air filter with a new one.  <a href="#">p.122</a></p> <p>If the error continues after checking the points above, stop using the projector, disconnect the power cable from the electrical outlet, and contact Epson.  <a href="#">p.114</a></p>
	Air Filter Notice	<p>"Time to clean the air filter. Clean or replace the air filter." is displayed. Clean the air filter.  <a href="#">p.116</a></p> <p>If the air filter is stained yellow with tobacco smoke and cannot be cleaned, replace it with a new one.</p> <p>The indicators or messages regarding "Air Filter Notice" are displayed only when <b>Air Filter Notice</b> is set to <b>On</b>, on the configuration menu's <b>Extended</b> menu.  <a href="#">p.67</a></p>



- If the projector is not operating properly, even though the indicators are all showing normal, refer to "When the Indicators Provide No Help".  [p.101](#)
- If the error is not indicated in this table, stop using the projector, disconnect the power cable from the electrical outlet, and contact Epson.  [p.114](#)

## When the Indicators Provide No Help

If any of the following problems occur and the indicators do not offer a solution, refer to the pages given for each problem.

### Problems relating to images

- "No images appear" 🖱️ p.103  
Projection does not start, the projection area is completely black, the projection area is completely blue, etc.
- "Moving images are not displayed (only the moving image portion turns black)." 🖱️ p.103  
Moving images being projected from a computer appear black and nothing is projected.
- "Projection stops automatically" 🖱️ p.103
- "The message "Not supported" is displayed." 🖱️ p.104
- ""No Signal" is displayed." 🖱️ p.104
- "Images are fuzzy or out of focus" 🖱️ p.105
- "Interference or distortion appears in images" 🖱️ p.105
- "The image is truncated (large) or small, or the aspect is not suitable" 🖱️ p.106  
Only part of the image is displayed, or the height and width ratios of the image are not correct, and so on.
- "Image colors are not right" 🖱️ p.106  
The whole image appears purplish or greenish, images are black & white, colors appear dull, etc. (Computer monitors and LCD screens have different color reproduction performance, so that the colors projected by the projector and the colors appearing on the monitor may not necessarily match, but this is not a sign of a problem.)
- "Images appear dark" 🖱️ p.107

## Problems when projection starts

- "No power supplied" 🖱️ p.107

## Other problems



- "The remote control does not work" 🖱️ p.109
- "Nothing appears on the external monitor" 🖱️ p.110
- "I want to change the language for messages and menus" 🖱️ p.110
- "Mail is not received even if a problem occurs in the projector" 🖱️ p.110
- ""The battery that saves your clock settings is running low." is displayed." 🖱️ p.111

## Interpreting Event IDs

- 🖱️ p.112

## Problems relating to images

No images appear

Check	Remedy
Did you press the [⏻] button?	Press the [⏻] button to turn the power on.
Are the indicators switched off?	The power cable is not connected correctly or power is not being supplied normally. Connect the projector's power cable correctly. Check that your electrical outlet or power source is functioning correctly.
Is Shutter active?	Press the [Shutter] button on the remote control to cancel Shutter.  <a href="#">p.39</a>
Are the configuration menu settings correct?	Reset All of the settings.  <b>Reset Menu - Reset All</b> <a href="#">p.91</a>
Is the projected image completely black? <b>Only when projecting computer images</b>	Some input images, such as screen savers, may be completely black.
Is the image signal format setting correct? <b>Only when projecting images from a video source</b>	Change the setting according to the signal for the connected equipment.  <b>Signal Menu - Video Signal</b> <a href="#">p.62</a>

Moving images are not displayed (only the moving image portion turns black).



Check	Remedy
Is the computer's image signal being output to the LCD and the monitor? <b>Only when projecting images from a laptop computer or a computer with a built-in LCD screen</b>	Change the image signal to external output only.  Check your computer's documentation.

Projection stops automatically



Check	Remedy
Is <b>Sleep Mode</b> set to <b>On</b> ?	Press the [⏻] button to turn the power on. If you do not want to use Sleep Mode, change the setting to <b>Off</b> .  <b>Extended Menu - Operation - Sleep Mode</b> <a href="#">p.67</a>

Check	Remedy
Is the air filter installed?	Check that the air filter is securely installed.  <a href="#">p.122</a> The projector automatically turns off about one minute after it detects that there is no air filter.

The message "Not supported" is displayed.



Check	Remedy
Is the image signal format setting correct? <b>Only when projecting images from a video source</b>	Change the setting according to the signal for the connected equipment.  <b>Signal Menu - Video Signal</b> <a href="#">p.62</a>
Do the image signal Resolution and the Refresh Rate are supported? <b>Only when projecting computer images</b>	Refer to the computer's documentation for how to change the image signal Resolution and the Refresh Rate output from the computer.  "Supported Monitor Displays" <a href="#">p.200</a>

"No Signal" is displayed.







Check	Remedy
Are the cables connected correctly?	Check that all the cables required for projection are securely connected.  <a href="#">p.154, p.156</a>
Is the correct input port selected?	Change the image by pressing the [Search] button on the remote control or the [Source Search] button on the control panel.  <a href="#">p.25</a>
Is the power for the computer or video source turned on?	Turn the power on for the source.
Are the image signals being output to the projector? <b>Only when projecting images from a laptop computer or a computer with a built-in LCD screen</b>	If the image signals are only being output to the computer's LCD monitor or to the accessory monitor, you need to change the output to an external destination as well as the computer's own monitor. For some computer models, when the image signals are output externally, they no longer appear on the LCD monitor or accessory monitor.  <a href="#">p.154</a>  If the connection is made while the power of the projector or computer is already turned on, the function [Fn] key that changes the computer's image signal to external output may not work. Turn the power for the computer and the projector off and then back on again.



## Images are fuzzy or out of focus

Check	Remedy
Is the focus adjusted correctly?	Make sure that at least 30 minutes has passed after the projection starts, and press the [Focus] button on the remote control to adjust the focus.
Is the projector at the correct distance?	Is it projecting outside of the recommended projection distance range? Setup within the recommended range.  <a href="#">p.198</a>
Is the Keystone adjustment value too large?	Lower the projection angle to reduce the amount of keystone correction.  <a href="#">p.166</a>
Has condensation formed on the lens?	If the projector is suddenly taken from a cold environment to a warm environment, or if sudden ambient temperature changes occur, condensation may form on the surface of the lens, and this may cause the images to appear fuzzy. Set the projector up in the room about one hour before it is used. If condensation forms on the lens, turn the projector off and wait for the condensation to disappear.

## Interference or distortion appears in images

Check	Remedy
Is the image signal format setting correct? <b>Only when projecting images from a video source</b>	Change the setting according to the signal for the connected equipment.  <b>Signal Menu - Video Signal</b> <a href="#">p.62</a>
Are the cables connected correctly?	Check that all the cables required for projection are securely connected.  <a href="#">p.154, p.156</a>
Is an extension cable being used?	If an extension cable is used, electrical interference may affect the signals. Use the cables supplied with the projector to check if the cables you are using may be causing the problem.
Is the correct resolution selected? <b>Only when projecting computer images</b>	Set the computer so that the signals being output are compatible with the projector.  "Supported Monitor Displays" <a href="#">p.200</a>  For more information, see your computer documentation.
Are the " <a href="#">Sync</a> " and " <a href="#">Tracking</a> " settings adjusted correctly? <b>Only when projecting computer analog RGB signals</b>	Press the [Auto] button on the remote control or the [Enter] button on the control panel to perform automatic adjustment. If the images are not adjusted correctly after using automatic adjustment, you can make the adjustments using <b>Sync</b> and <b>Tracking</b> from the configuration menu.  <b>Signal Menu - Tracking, Sync.</b> <a href="#">p.62</a>
Is the <b>Resolution</b> set to <b>Manual</b> ? <b>Only when projecting on a split screen</b>	The image may be collapsed if the <b>Resolution</b> on the configuration menu and the resolution of the projected image are not the same. If the image is collapsed, set the <b>Resolution</b> to <b>Auto</b> .  <b>Signal Menu - Resolution</b> <a href="#">p.62</a>

The image is truncated (large) or small, or the aspect is not suitable

Check	Remedy
Is the aspect adjusted correctly?	Press the [Aspect] button on the remote control to select an aspect suitable for the input source. ☞ p.27
Is a wide panel computer image being projected? <b>Only when projecting computer images</b>	Change the setting according to the signal for the connected equipment. ☞ <b>Signal Menu - Resolution</b> p.62
Is the image still being enlarged by E-Zoom?	Press the [Esc] button on the remote control to cancel E-Zoom. ☞ p.41
Is <b>Scale</b> set to <b>On</b> ?	Set <b>Scale</b> to <b>Off</b> on the configuration menu. ☞ <b>Signal Menu - Scale</b> p.62
Is <b>Position</b> adjusted correctly?	Press the [Auto] button on the remote control or the [Enter] button on the control panel to automatically adjust the position of projected images from a computer. If the images are not adjusted correctly after using automatic adjustment, you can make the adjustments using <b>Position</b> from the configuration menu.  Apart from computer analog RGB signals, you can adjust other signals while projecting by adjusting <b>Position</b> from the configuration menu. ☞ <b>Signal Menu - Position</b> p.62
Is the computer set for dual display? <b>Only when projecting computer images</b>	If dual display is activated in the "Display Properties" of the computer's Control panel, only about half of the image on the computer screen is projected. To display the entire image on the computer screen, turn off the dual display setting. ☞ Computer video driver documentation
Is the correct resolution selected? <b>Only when projecting computer images</b>	Set the computer so that the signals being output are compatible with the projector. ☞ "Supported Monitor Displays" p.200 ☞ Computer documentation

Image colors are not right

Check	Remedy
Do the input signal settings match the signals from the connected device?	Change the setting according to the signal for the connected equipment. ☞ <b>Signal Menu - Input Signal, Video Signal</b> p.62
Is the image Brightness set correctly?	Adjust the <b>Brightness</b> setting from the configuration menu. ☞ <b>Image Menu - Brightness</b> p.60
Are the cables connected correctly?	Check that all the cables required for projection are securely connected. ☞ p.154, p.156
Is <b>Contrast</b> adjusted correctly?	Adjust the <b>Contrast</b> setting from the configuration menu. ☞ <b>Image Menu - Contrast</b> p.60
Is the Color Adjustment correctly?	Adjust the <b>Advanced</b> setting from the configuration menu. ☞ <b>Image Menu - Advanced</b> p.60

Check	Remedy
Are the <b>Color Saturation</b> and <b>Tint</b> adjusted correctly? <b>Only when projecting images from a video source</b>	Adjust the <b>Color Saturation</b> and <b>Tint</b> settings from the configuration menu. 🖱️ <b>Image Menu - Color Saturation, Tint</b> <a href="#">p.60</a>





## Images appear dark

Check	Remedy
Is the image Brightness set correctly?	Adjust the <b>Brightness</b> and <b>Power Consumption</b> settings from the configuration menu. 🖱️ <b>Image Menu - Brightness</b> <a href="#">p.60</a> 🖱️ <b>Settings Menu - Power Consumption</b> <a href="#">p.65</a>
Is <b>Contrast</b> ▶▶ adjusted correctly?	Adjust the <b>Contrast</b> setting from the configuration menu. 🖱️ <b>Image Menu - Contrast</b> <a href="#">p.60</a>
Is the lamp due for replacement?	When the lamp is nearly ready for replacement, the images become darker and the color quality becomes poorer. When this happens, replace the lamp with a new lamp. 🖱️ <a href="#">p.119</a>
Is <b>Multi-Projection</b> set to <b>On</b> ?	<b>Brightness Level</b> or <b>Brightness Correct.</b> on <b>Multi-Projection</b> could be set. If not projecting from multiple projectors, set <b>Multi-Projection</b> to <b>Off</b> . 🖱️ <b>Extended Menu - Multi-Projection</b> <a href="#">p.67</a>

## Problems when projection starts









### No power supplied

Check	Remedy
Did you press the [⏻] button?	Press the [⏻] button to turn the power on.
Are the indicators switched off?	The power cable is not connected correctly or power is not being supplied normally. Disconnect and then reconnect the power cable. Check that your electrical outlet or power source is functioning correctly.

Check	Remedy
Do the indicators turn on and off when the power cable is touched?	There is probably a poor contact in the power cable, or the power cable may be defective. Reinsert the power cable. If this does not solve the problem, stop using the projector, disconnect the power cable from the electrical outlet, and contact Epson.  <a href="#">p.114</a>
Is <b>Control Panel Lock</b> set to <b>Full Lock</b> ?	Press the [⏻] button on the remote control. If you do not want to use Control Panel Lock, change the setting to <b>Off</b> .  <a href="#">Settings Menu - Control Panel Lock p.65</a>
Is the correct setting for the remote receiver selected?	Check the <b>Remote Receiver</b> from the configuration menu.  <a href="#">Settings Menu - Remote Receiver p.65</a>
Was the power cable plugged back in or was the breaker turned on immediately after Direct Power Off?	Even when <b>Direct Power On</b> is set to <b>On</b> , the power may not turn back on. Press the [⏻] button to turn the power back on in these instances.
Is the ID switch on the side of the remote control set to On?	When the switch is set to On, you can use the remote control to operate only a projector with a matching ID. Set ID switch to Off.  <a href="#">p.177</a>
Are the lamp cover and lamps installed correctly?	If the lamp or lamp cover is installed incorrectly, the projector cannot be turned on. Check how it is installed.  <a href="#">p.119</a>

## Other problems

The remote control does not work

Check	Remedy
Is the remote control light-emitting area pointing towards the remote receiver on the projector when it is operated?	Point the remote control towards the remote receiver.  <a href="#">p.23</a>
Is the remote control too far from the projector?	The operating range for the remote control is about 49 ft (15 m).  <a href="#">p.23</a>
Is direct sunlight or strong light from fluorescent lamps shining onto the Remote Receiver?	Set the projector up in a location where strong light does not shine onto the remote receiver. Or set the remote receiver to <b>Off</b> from <b>Remote Receiver</b> in the configuration menu.  <b>Settings Menu - Remote Receiver</b> <a href="#">p.65</a>
Is the correct setting for the remote receiver selected?	Check the <b>Remote Receiver</b> from the configuration menu.  <b>Settings Menu - Remote Receiver</b> <a href="#">p.65</a>
Are the batteries dead or have the batteries been inserted correctly?	Make sure the batteries are inserted correctly or replace the batteries with new ones if necessary.  <a href="#">p.22</a>
Are the remote control ID and the projector ID matched?	Make sure the ID for the projector you want to operate and the ID for the remote control match. To operate all projectors by remote control regardless of the ID setting, set the ID switch on the side of the remote control to Off.  <a href="#">p.175</a>
Does <b>Remote Control Type</b> match the remote control that you are using?	Check the <b>Remote Control Type</b> on the configuration menu.  <b>Extended Menu - Operation - Remote Control Type</b> <a href="#">p.67</a>
Is the optional remote control cable connected to the remote control or to the projector's Remote port?	When the remote control cable is connected, the remote control light-emitting area or the projector's remote receiver are disabled. When not using the remote control cable set, disconnect it from the remote control and the Remote port.
Is the remote control button lock set?	When the remote control button lock is set, buttons except for those needed for basic remote control operations are deactivated. Hold down the <b>[Help]</b> button to cancel the remote control button lock.  <a href="#">p.47</a>

## Nothing appears on the external monitor

Check	Remedy
Are images input from a port other than the Computer or BNC input port?	Only RGB signals from the Computer input port or the BNC input port can be displayed on an external monitor.
Are you projecting a split screen?	Only RGB signals projected on the left screen from the Computer input port or the BNC input port can be displayed on an external monitor.  <a href="#">p.35</a>



## I want to change the language for messages and menus

Check	Remedy
Change the <b>Language</b> setting.	Adjust the <b>Language</b> setting from the configuration menu.  <b>Extended Menu - Language</b> <a href="#">p.67</a>

## The authentication setting of wireless LAN fails

Check	Remedy
Is the time set correctly?	If the wireless LAN is set correctly but the authentication setting fails, the time may not be set correctly. Check if it is set correctly.  <b>Extended Menu - Time/Schedule Settings</b> <a href="#">p.67</a>

## Mail is not received even if a problem occurs in the projector

Check	Remedy
Is <b>Standby Mode</b> set to <b>Communication On</b> ?	To use the Mail Notification function when the projector is in standby, set <b>Communication On</b> in <b>Standby Mode</b> from the configuration menu.  <b>Extended Menu - Standby Mode</b> <a href="#">p.67</a>
Did a fatal abnormality occur and the projector come to a sudden stop?	When the projector comes to a sudden stop, e-mail cannot be sent. If the abnormal state continues, contact Epson.  <a href="#">p.114</a>
Is power being supplied to the projector?	Check that your electrical outlet or power source is functioning correctly.



Check	Remedy
Is <b>Mail Notification</b> function set correctly in the configuration menu?	Mail notification of problems is sent according to the settings on the <b>Mail Notification</b> menu in the configuration menu. Check if it is set correctly.  ☛ <b>Network</b> Menu - <b>Mail Notification</b> Menu <a href="#">p.84</a>

"The battery that saves your clock settings is running low." is displayed.

Cause	Remedy
The internal power supply that saves your clock settings is running low.	Contact your local dealer or Epson. ☛ <a href="#">p.114</a>

## Interpreting Event IDs

Check the event ID and perform the remedy given below. If the problem cannot be solved, contact the network administrator or one of the following contact addresses.  [p.114](#)

Event ID	Cause	Remedy
0432 0435	Failed to startup EasyMP Network Projection.	Restart the projector.
0434 0481 0482 0485	Network communication is unstable.	Check the status of network communications. Wait for a while and then try connecting again.
0433	An image that was transferred cannot be reproduced.	Restart EasyMP Network Projection.
0484	Communications was cut off from the computer.	
04FE	EasyMP Network Projection ended unexpectedly.	Check the status of network communications. Restart the projector.
04FF	A system error occurred in the projector.	Restart the projector.
0891	The same SSID access point cannot be found.	Set the computer, the access point, and the projector to the same SSID.
0892	The WPA and WPA2 authentication methods are not the same.	Check the wireless LAN security setting to see if it is correct.  <b>Network Menu - Security Menu</b> <a href="#">p.77</a>
0893	The WEP, TKIP, and AES encoding methods are not the same.	
0894	Communications was cut off because a connection was made to the wrong access point.	Check with the network administrator and follow their instructions.
0898	Failed to obtain the DHCP.	Check the DHCP server to see if it is operating correctly and check the LAN cable to see if it is connected correctly. Turn off DHCP if it is not being used.  <b>Network Menu - Wireless LAN Menu</b> <a href="#">p.74</a> , <b>Wired LAN Menu</b> <a href="#">p.81</a>
0899	Other connection errors	If the problem cannot be solved by restarting the projector or EasyMP Network Projection, contact one of the following contact addresses.  <a href="#">p.114</a>



Event ID	Cause	Remedy
089A	The EAP authentication type is not the same.	Check the wireless LAN security setting to see if it is correct. Also, check if the certificate is imported correctly.  <b>Network</b> Menu - <b>Security</b> Menu <a href="#">p.77</a>
089B	EAP server authentication failed.	
089C	EAP client authentication failed.	
089D	Key exchange failed.	

## Where to Get Help

If you need to contact Epson for technical support services, use the following support options.

---

## Internet Support

Visit Epson's support website at [www.epson.com/support](http://www.epson.com/support) (U.S.) or [www.epson.ca/support](http://www.epson.ca/support) (Canada) for solutions to common problems with your projector. You can download utilities and documentation, get FAQs and troubleshooting advice, or e-mail Epson with your questions.

---

## Speak to a Support Representative

To use the EPSON PrivateLine Support service, call (800) 637-7661 and enter the PIN on the EPSON PrivateLine Support card included with your projector. This service is available for the duration of your warranty period. You may also speak with a projector support specialist by dialing (562) 276-4394 (U.S.) or (905) 709-3839 (Canada).

Support hours are 6 AM to 8 PM, Pacific Time, Monday through Friday and 7 AM to 4 PM, Pacific Time, Saturday.

Days and hours of support are subject to change without notice. Toll or long distance charges may apply.

Before you call for support, please have the following information ready

- Product name
- Product serial number (located on the bottom or rear of the projector, or in menu system)
- Proof of purchase (such as a store receipt) and date of purchase
- Computer or video configuration
- Description of the problem

---

## Purchase Supplies and Accessories

You can purchase screens, other optional accessories, and replacement parts from an Epson authorized reseller. To find the nearest reseller, call 800-GO-EPSON (800-463-7766). Or you can purchase online at [www.epsonstore.com](http://www.epsonstore.com) (U.S. sales) or [www.epson.ca](http://www.epson.ca) (Canadian sales).

To purchase a replacement remote control, call (562) 276-4394 (U.S.) or (905) 709-3839 (for dealer referral in Canada).

# Maintenance

This chapter explains the maintenance methods that are required to ensure a long projector service life.

**Cleaning**

You should clean the projector if it becomes dirty or if the quality of projected images starts to deteriorate.

**Warning**

*Do not use sprays containing a flammable gas to remove dirt or dust which is adhering to parts such as the lens or filter of the projector.*

*This could cause a fire due to the high temperature of the lamps inside the unit.*

---

**Cleaning the Projector's Surface**

Clean the projector's surface by wiping it gently with a soft cloth.

If the projector is particularly dirty, moisten the cloth with water containing a small amount of neutral detergent, and then firmly wring the cloth dry before using it to wipe the projector's surface.

**Caution**

*Do not use volatile substances such as wax, alcohol, or thinner to clean the projector's surface. The quality of the case may change or become discolored.*

---

**Cleaning the Lens**

Use a commercially available cloth for cleaning glasses to gently wipe the lens.

**Caution**

*Do not rub the lens with harsh materials or subject the lens to shocks, as it can easily become damaged.*

---

**Cleaning the Air Filter**

Clean the air filter and the air intake vent when the following message is displayed or the Filter indicator is flashing green.

"Time to clean the air filter."

"Clean or replace the air filter."

**Caution**

- *If dust collects on the air filter it can cause the internal temperature of the projector to rise, and this can lead to problems with operation and shorten the optical engine's service life. Clean the air filter immediately when the message is displayed.*
- *If the air filter is stained yellow with tobacco smoke, it cannot be cleaned. In this case, replace it with a new air filter.  p.122*
- *Do not rinse the air filter in water. Do not use detergents or solvents.*
- *When using a brush for cleaning, use one with long soft bristles, and brush it lightly. If it is brushed too strongly, dust will be ground into the air filter and cannot be removed.*

**Procedure**

**Press the [⏻] power button on the remote control or the back of the projector to turn off the projector's power. After the confirmation buzzer beeps twice, disconnect the power cable.**

**2 Remove the air filter cover.**

Grip the air filter cover tab between your fingers, and pull up and remove the cover while pressing the tab.

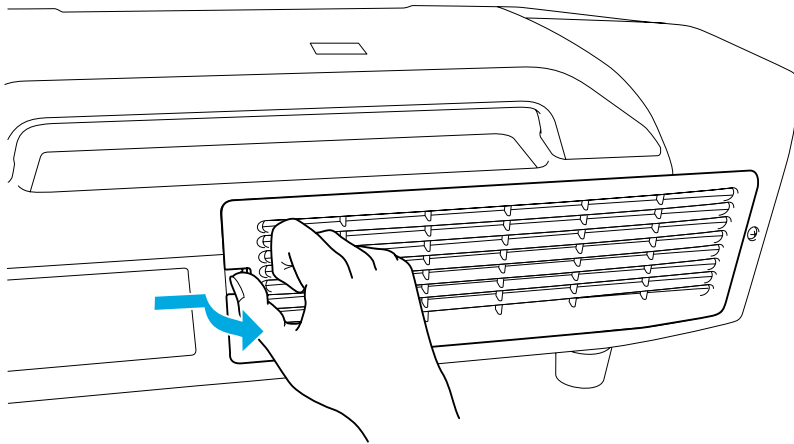

**3 Remove the air filter.**

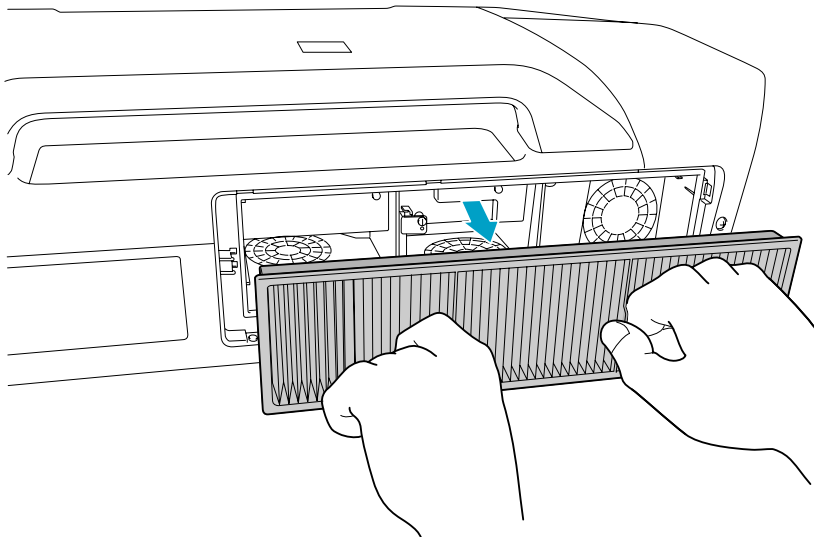

**4 With the front (the side with tabs) of the air filter facing down, tap the air filter four or five times to shake off the dust.**

Turn it over and tap the other side in the same way.

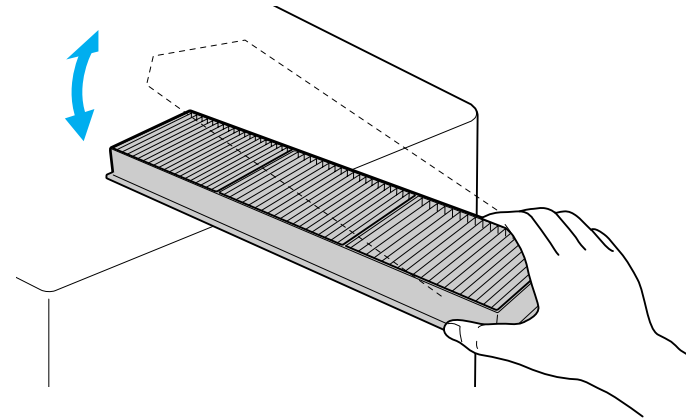

**Caution**

*If the air filter is hit too hard, it may become unusable due to deformities and cracks.*

- 5 Remove any dust remaining on the air filter by using a vacuum cleaner from on front side.

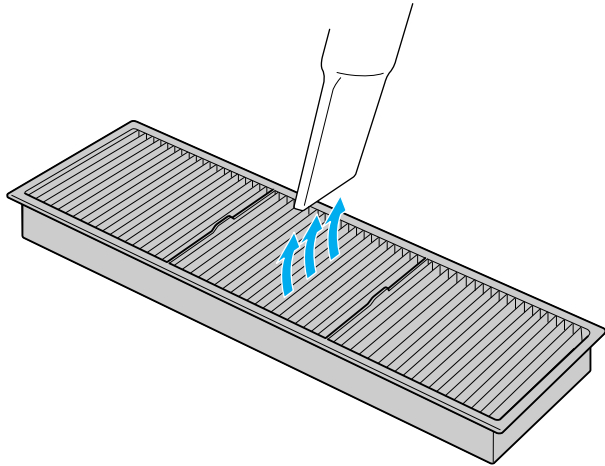

- 6 Reinsert the air filter.

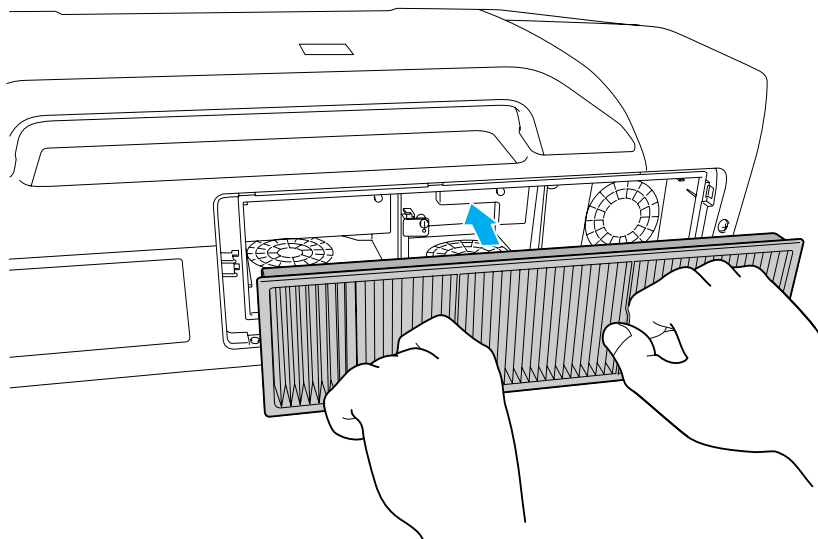

- 7 Reinsert the air filter cover.  
Press until it clicks into place.

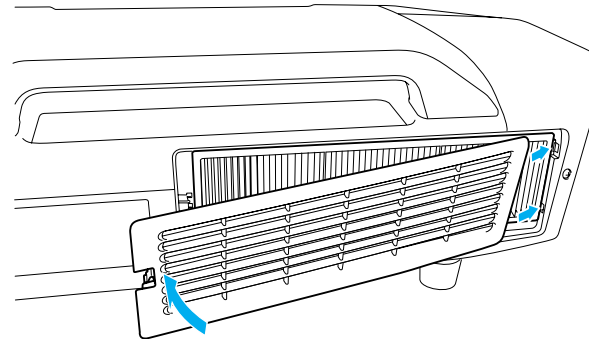

If a message is frequently displayed, even after cleaning, it is time to replace the air filter. Replace it with a new air filter.  [p.122](#)

## Replacing the Lamps

### Lamp replacement period

It is time to replace the lamp when:

- The message "Replace the lamp." is displayed at the lower left of the projection screen when you start projecting.

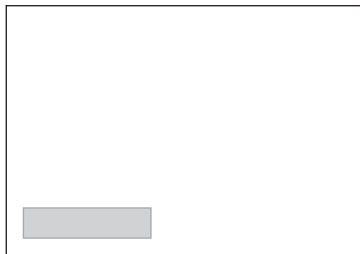

- The lamp indicator flashes orange.

Replace the lamp indicated by the flashing indicator, either lamp 1 or 2.

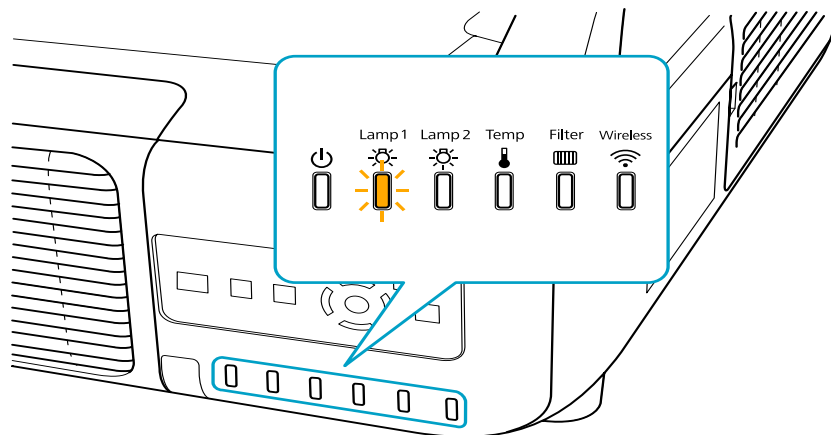

- The projected image gets darker or starts to deteriorate.

### Caution

- The lamp replacement message is set to appear after the following time periods in order to maintain the initial brightness and quality of the projected images.  
*PowerLite Pro Z8250NL/Z8255NL/Z8350WNL/Z8450WUNL/Z8455WUNL*  
 When **Power Consumption** is set continually at Normal 1: About 2400 hours  
 When **Power Consumption** is set continually at ECO: About 3400 hours  
*PowerLite Pro Z8150NL: About 2400 hours*
- Do not turn the projector on immediately after turning it off. Turning the projector on and off frequently may shorten the life of the lamps.
- If you continue to use the lamp after the replacement period has passed, the possibility that the lamp may explode increases. When the lamp replacement message appears, replace the lamp with a new one as soon as possible, even if it is still working.
- Depending on the characteristics of the lamp and the way it has been used, the lamp may become darker or stop working before the lamp warning message appears. We recommend that you keep a replacement lamp on hand at all times.



We recommend that you clean the air filter whenever you replace the lamp. [p.116](#)

Replace the air filter if it is discolored or if a message appears even after cleaning the air filter. [p.122](#)

### How to replace the lamp

The lamps can be replaced even when the projector is suspended from a ceiling.

### Warning

- When replacing a lamp because it has stopped illuminating, there is a possibility that the lamp may be broken. If replacing the lamp of a projector that is installed on the ceiling, you should always assume that the lamp is broken, and you should stand to the side of the lamp cover, not underneath it. Remove the lamp cover gently.

- *Never disassemble or remodel the lamp. If a remodeled or reassembled lamp is installed into the projector and used, it could cause a fire, electric shock, or an accident.*

## Warning

Wait until the lamps have cooled down sufficiently before removing the lamp cover. If the lamp is still hot, burns or other injuries may result. It takes about one hour after the power has been turned off for the lamp to be cool enough.

## Procedure

- 1 Press the [⏻] power button on the remote control or the back of the projector to turn off the projector's power. After the confirmation buzzer beeps twice, disconnect the power cable.

- 2 Wait until the lamps have cooled down sufficiently before removing the lamp cover on the back of the projector.

Pinch the tabs on the front of the lamp cover together to release the lock. When the lock releases, pull the cover straight out.

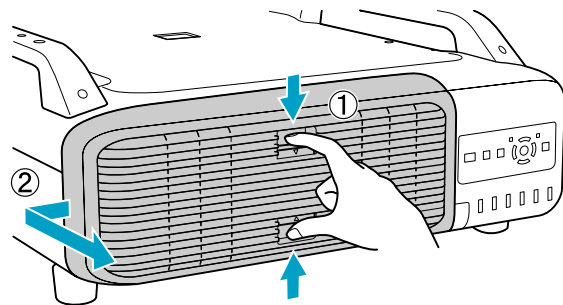

- 3 Pull up the lock lever for the lamp you want to replace and pull the lamp straight out.

If the lamp is cracked, replace it with a new lamp, or contact Epson.

☞ p.114

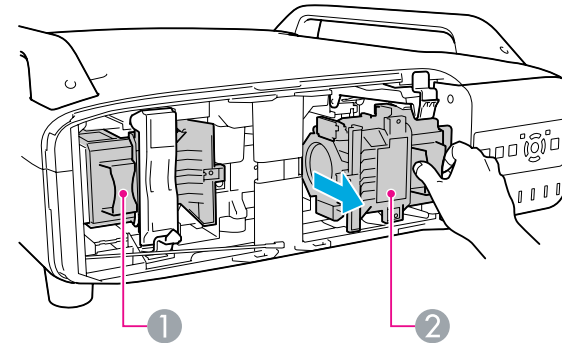
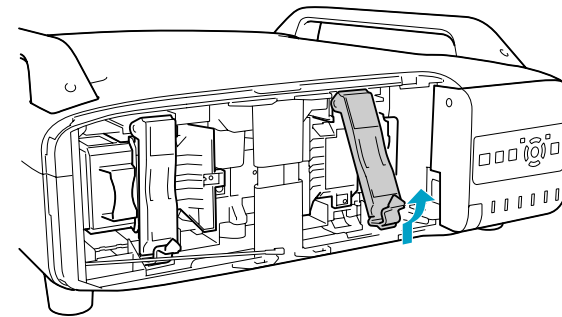

- 1 Lamp 1
- 2 Lamp 2



## 4 Install the new lamp.

Insert the lamp along the guide rail in the correct direction so that it fits in place and press it firmly to the back. Pull down the lock lever until it clicks into place.

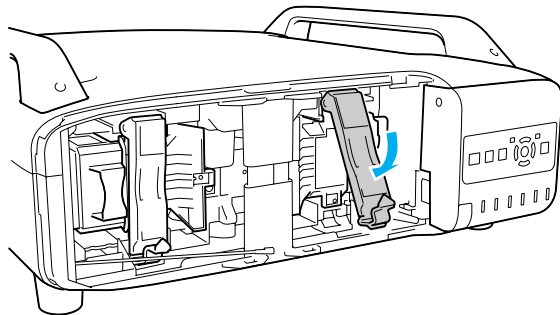
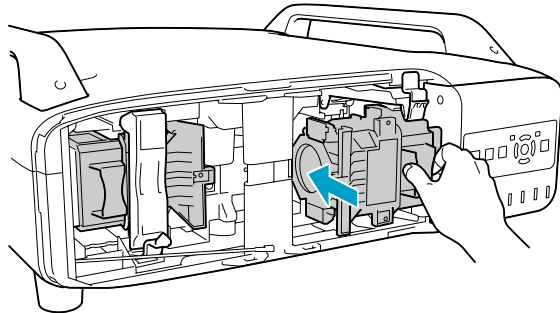

## 5 Reinstall the lamp cover.

Press the cover against the unit and slide it to the right until it clicks.

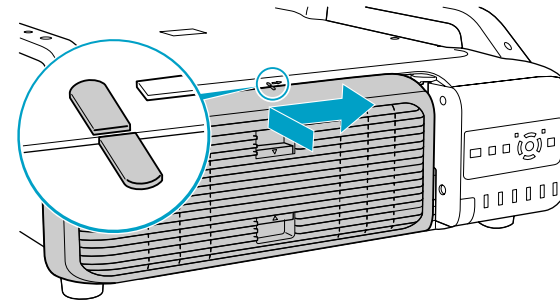

### Caution

- Make sure you install the lamp securely. If the lamp cover is removed, the lamps turn off automatically as a safety precaution. If the lamp or the lamp cover is not installed correctly, the lamp will not turn on.
- (Hg) The lamp(s) in this product contain mercury. Please consult your state and local regulations regarding disposal or recycling. Do not put in the trash.

### Resetting the Lamp Hours

The projector records lamp life and a message and indicator notify you when it is time to replace the lamp. After replacing the lamps and turning on the power, the following message is displayed on the screen and you can reset the lamp-hour counter.

Select **Yes**, and then press the [Enter] button.

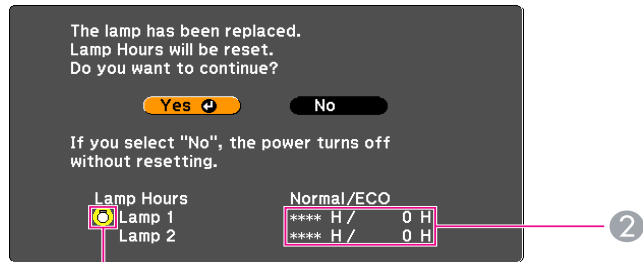

1

- 1 Indicates that lamp 1 has been replaced.
- 2 Displays the cumulative lamp operating time. If you select **Yes** and reset the Lamp Hours, the count for lamp 1 is set to 0H.

## Replacing the Air Filter

### Air filter replacement period

It is time to replace the air filter when:

- The air filter is discolored.
- The message is displayed even though the air filter has been cleaned.

### How to replace the air filter

The air filter can be replaced even when the projector is suspended from a ceiling.

### Procedure

- 1 Press the [⏻] power button on the remote control or the back of the projector to turn off the projector's power. After the confirmation buzzer beeps twice, disconnect the power cable.
- 2 Remove the air filter cover. Grip the air filter cover tab between your fingers, and pull up and remove the cover while pressing the tab.

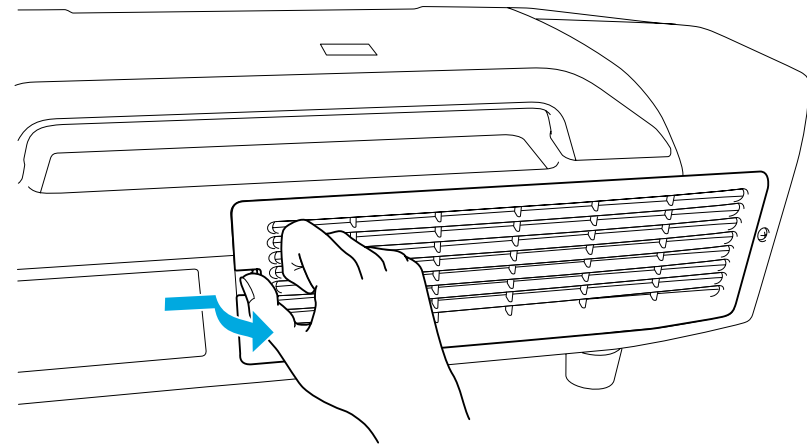

**3** Remove the air filter.

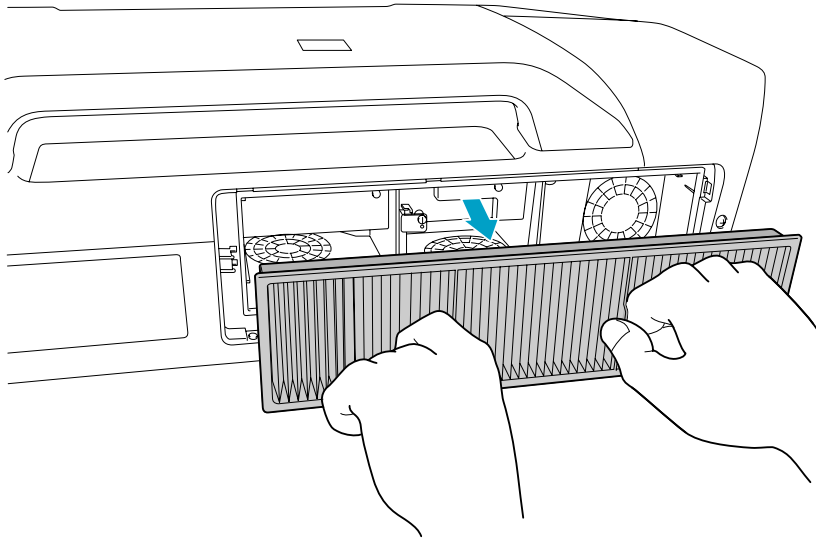

**4** Install the new air filter.

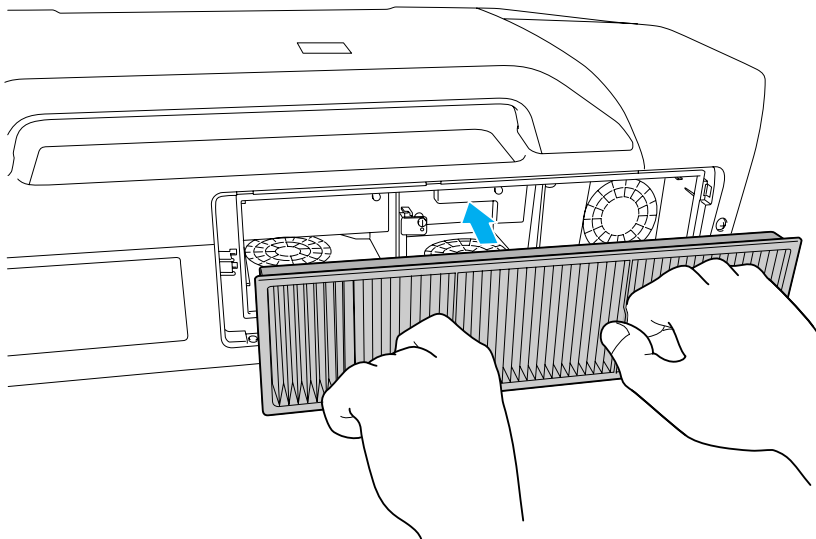

**5** Replace the air filter cover.

Press until it clicks into place.

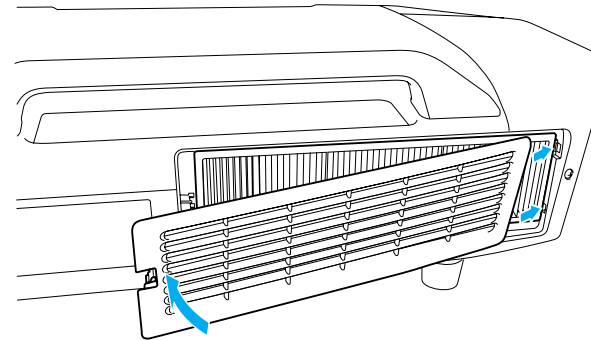

**Caution**

- Air filters contain polypropylene. Dispose of used air filters according to local regulations.

## Notes on Transportation

There are many glass parts and precision components inside the projector. To prevent damage due to impacts when transporting, handle the projector as follows.

---

## Moving Nearby

Do the following, and then carry carefully by the handles.

- Turn off the power to the projector and disconnect all cables.
- Attach the cover to the lens.

### Warning

*Do not carry the projector by one person.*

*Two people are needed to unpack or carry the projector.*

---

## When Transporting

### Preparing packaging

Use the lens shift function to horizontally and vertically center the lens. Then, follow the instructions in "Moving Nearby", and the additional instructions below.

- Remove the lens unit.
- Attach the cover that was on the lens mount when you purchased the projector.
- The vertical and horizontal lens shifts are positioned in the center.
- Fit the protective lens pad that came with the projector.

## Notes when packing and transporting

Enclose the projector securely in cushioning material to protect it from shock, and place it into a strong cardboard container. Be sure to notify the carrier company that the contents are fragile.

## Image Maintenance

## Panel Alignment

Adjusts the color gaps between pixels on the LCD panel.

### Procedure

- 1 During projection, press the [Menu] button. Select Extended menu - "Display" and then press the [Enter] button. Select "Panel Alignment" and press the [Enter] button.

#### Using the Remote Control

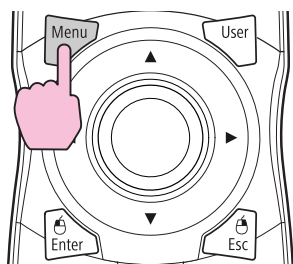

#### Using the Control Panel

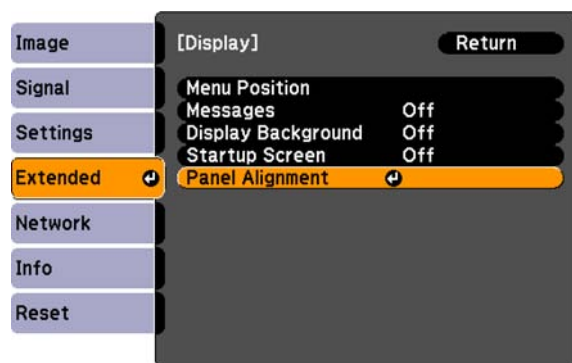
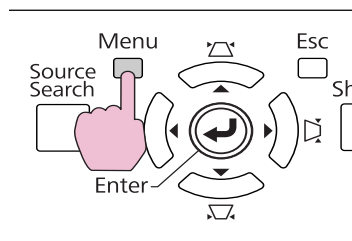

- 2 Set the "Panel Alignment" setting to "On".

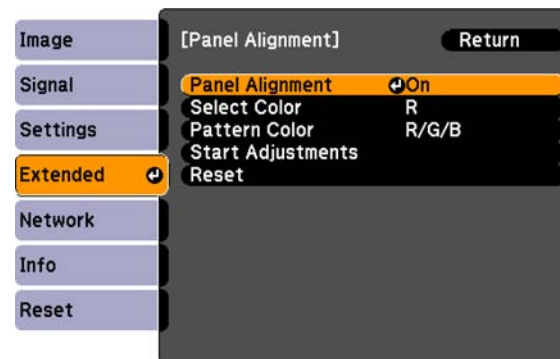

- 3 Set the "Select Color" setting to the color you want to adjust for.

- 4 Set the "Pattern Color" setting to the pattern or colors you want to adjust with.

- 5 Select "Start Adjustments" and press the [Enter] button. Press [Enter] again at the next confirmation screen.

An adjustment screen appears and all four corners of the screen can be adjusted starting with the top-left corner.

- 6 Use the arrow buttons to correct any visible misalignment in the highlighted corner.

- 7 When you've finished adjusting the highlighted corner, press the [Enter] button to adjust the next corner. Repeat this process for each of the four corners.

8

**After adjusting all four corners, select [Exit], and press the [Enter] button.**

If your projector requires additional adjustments, choose "Select intersection and adjust" to perform a detailed correction at any of the grid intersection points. Use the arrow buttons to highlight any of the intersection points and press the [Enter] button to select and begin adjusting that point.

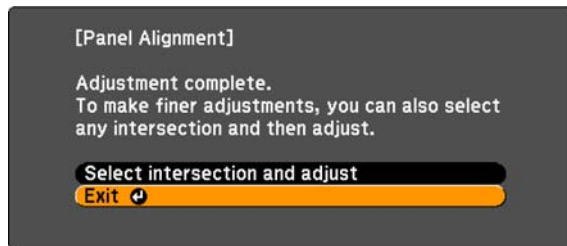

# Monitoring and Controls

This chapter explains the functions that can be used to monitor and control the projector.

## EasyMP Monitor

EasyMP Monitor lets you carry out operations such as checking the status of multiple Epson projectors that are connected to a network from a computer monitor, and controlling the projectors from the computer.

Download the EasyMP Monitor software from the following website.

<http://www.epson.com>

Following are brief descriptions of the monitoring and control functions that can be carried out using EasyMP Monitor.

- **Registering projectors for monitoring and control**

Projectors on the network can be searched for automatically, and you can then select projectors to be registered from the projectors that are detected.

You can enter the IP addresses for projectors to register them.

- **Registered projectors can also be assigned to groups so that they can be monitored and controlled in groups.**

- **Monitoring the status of registered projectors**

The power status (ON/OFF) for projectors and problems or warnings requiring attention can be checked visually by means of icons.

You can select groups of projectors or a single projector that you are interested in, and then check the cumulative lamp operating time or the details of information such as input sources, problems, and warnings for these projectors.

- **Controlling registered projectors**

Projectors can be selected in groups or as single projectors, and you can then carry out operations for the selected projectors such as turning the power on and off and switching their input sources.

Web Control functions can be used to change the settings in the projector's configuration menu.

If there are certain control actions which are carried out regularly at particular times or on particular days, you can use Timer Settings to register timer settings.

- **Mail Notification settings**

You can set e-mail addresses to which notifications are sent if a status requiring attention, such as a problem, occurs with a projector that has been registered.

- **Sending messages to registered projectors**

The Message Broadcasting plugin for EasyMP Monitor can be used to send JPEG files to registered projectors.  [p.143](#)



## Changing Settings Using a Web Browser (Web Control)

You can make Configuration menu settings and control the projector by using the Web browser of a computer that is connected to the projector via a network. Setup and control operations can be performed remotely if this function is used. In addition, you can use the computer's keyboard, so it is easier to enter characters needed for setup, such as certificate settings.

Use Microsoft Internet Explorer 6.0 or later as the Web browser. If using a Mac OS, use Safari or Firefox.



- When communicating with a wireless LAN, connect in *Advanced mode*. p.74
- Setup and control with a Web browser are possible if **Standby Mode** is set to **Communication On** from the **Extended** menu of the projector's Configuration menu, even if the projector is in standby state (when the power is off). p.67

## Displaying Web Control

Use the following procedure to display Web Control.



- If your Web browser is set up to connect via a proxy server, Web Control cannot be displayed. To use Web Control, you need to make network connection settings with a device other than a proxy server.
- When setting the security using Web Control, we recommend setting *Secure HTTP* to *On*. p.82

### Procedure

- 1 Start the Web browser on the computer.



- 2 Enter the IP address of the projector in the address field of the Web browser, and press the [Enter] key on the computer's keyboard.

Web Control is displayed.

When Web Control Password is set in the Network menu from the projector's Configuration Menu, enter the password. Enter **EPSONWEB** as the user name. Enter the characters set for the web control password as the password. The default password is **admin**.

## Displaying Web Remote

The Web Remote function allows you to perform projector remote control operations from a Web browser.

### Procedure



- 1 Display Web Control. "Displaying Web Control" p.129



- 2 Click Web Remote.

### Example: Web browser of a computer



### 3 The Web Remote screen appears.

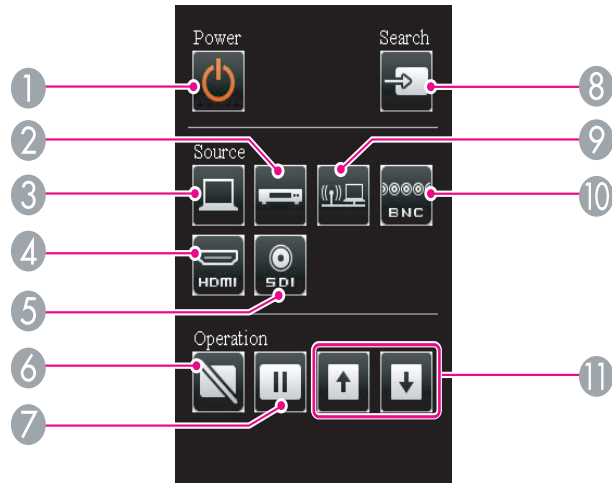

Name	Function
<b>1</b> [Power] button	Turns the projector power On or Off.
<b>2</b> [Video] button	Each time the button is pressed, the image displayed changes between the <b>Video</b> input port and <b>S-Video</b> input port.
<b>3</b> [Computer] button	The input source will change to <b>Computer</b> .
<b>4</b> [HDMI] button	Each time the button is pressed, the image displayed changes between the <b>HDMI1</b> input port and <b>HDMI2</b> input port.
<b>5</b> [SDI] button	The input source will change to <b>SDI</b> . (PowerLite Pro Z8450WUNL/Z8455WUNL only)
<b>6</b> [Shutter] button	Turns the video on or off. 🖱️ p.39
<b>7</b> [Freeze] button	Images are paused or unpaused. 🖱️ p.39

Name	Function
<b>8</b> [Search] button	Changes to the next input source that is connected to the projector and is sending an image. 🖱️ p.25
<b>9</b> [LAN] button	The input source will change to <b>LAN</b> .
<b>BNC</b> button	The input source will change to <b>BNC</b> .
<b>[Page] buttons</b> [↑][↓]	These buttons can be used to page up and down when projecting an image from a computer that is connected to the projector through the network.

## Displaying Lens Control

The Lens Control function allows you to operate the projector's lens from a web browser.

### Procedure

- 1** Display Web Control. 🖱️ "Displaying Web Control" p.129
- 2** Click Lens Control.

Example: Web browser of a computer



**3** The Lens Control screen appears.

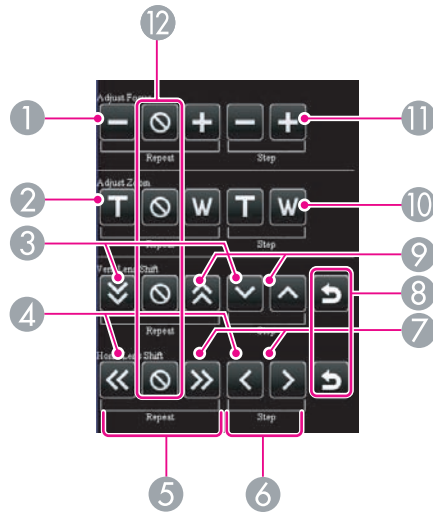

Name	Function
<b>1</b> [Scale down] button	Adjusts the focus.
<b>2</b> [Tele] button	Reduces the image without changing the projection size.
<b>3</b> [Down] button	Shifts the lens downward.
<b>4</b> [Left] button	Shifts the lens leftward.
<b>5</b> [Repeat] button	Continues adjusting until the [Stop] button is pressed.
<b>6</b> [Step] button	Adjusts by one step each time the button is pressed.
<b>7</b> [Right] button	Shifts the lens rightward.
<b>8</b> [Default Shift] button	Resets the lens to it's default position.
<b>9</b> [Up] button	Shifts the lens upward.

Name	Function
[Wide] button	Enlarges the image without changing the projection size.
[Scale Up] button	Adjusts the focus.
[Stop] button	Stops the adjustment.

## Setting Certificates

You can use a web browser to set the certificate settings used for wireless LAN authentication.

Install the following certificates in the projector: Client Certificate and CA certificate for wireless LAN security settings, and Web Server Certificate for the Secure HTTP function.

### Procedure

- 1** Display Web Control. "Displaying Web Control" p.129
- 2** Click Network menu - Administrator Settings - Manage Certificates.
- 3** The Manage Certificates screen appears.

Sub Menu	Items/Values
Client Certificate	Refresh/Clear
	Issued to
	Issued by
	Validity period

Sub Menu	Items/Values
<b>CA certificate</b>	Refresh/Clear
	Issued to
	Issued by
	Validity period
<b>Self-signed Certificate</b>	Refresh/Clear
	Issued to
	Issued by
	Validity period
<b>Web Server Certificate</b>	Refresh/Clear
	Issued to
	Issued by
	Validity period

A certificate is used in communication using HTTPS protocol, to certify reliability of the server. The projector automatically creates and communicates its self-signed certificate. This self-signed certificate cannot verify reliability from a computer's web browser, so it shows a warning on reliability of the server when you access from a web browser. Ignore this warning.

You can separately create a server certificate which can be verified from a computer's web browser, and install it in the projector to prevent this warning.  ["Supported Certificates" p.202](#)



When installing a certificate, make sure the projector supports its format.  ["Supported Certificates" p.202](#)

---

## Secure HTTP Notes

When Secure HTTP is set to On, security using HTTPS protocol is automatically applied between the projector and web browser of the computer connected to the network. You can use this function for secure communication between the projector and Web browser.

## Using the Mail Notification Function to Report Problems

By setting the **Mail Notification** function from the projector's Configuration Menu, notification messages will be sent to the preset email addresses when a problem or warning occurs with a projector. This will enable the operator to be notified of problems with projectors even at locations away from the projectors.  Network Menu - Administrator Settings - Mail Notification [p.84](#)



- Up to three notification destinations (Addresses) can be recorded, and notification messages can be sent to all three destinations at once.
- If a projector develops a critical problem and suddenly stops working, it may not be able to send a message notifying an operator of the problem.
- Monitoring is possible if **Standby Mode** is set to **Communication On** from the **Extended** menu of the projector's Configuration Menu, even if the projector is in standby state (when the power is off).  [p.67](#)

## Reading Problem Mail Notification Function

When the **Mail Notification** function is set to **On** and a problem/warning occurs in the projector, the following e-mail is sent.

Sender: Email Address 1

Subject: EPSON Projector

Line 1: The name of the projector where the problem has occurred

Line 2: The IP address set for the projector where the problem has occurred.

Line 3 and on: Details of the problem

The details of the problem are listed line by line. The following table shows the details that are given in the message for each item. To deal with problems/warnings, see "Reading the Indicators"  [p.96](#)

Message	Cause (Problems/Warnings)
Clean Air Filter	Air Filter Notice
Fan related error	Fan Error
High-speed cooling in progress	High Temp Warning
Internal error	Internal Error
Internal temperature error	High Temp Error (Overheating)
Lamp cover is open.	Lamp Cover Open
Lamp out	Lamp Error
Lamp replacement notification	Replace Lamp
Lamp timer failure	Lamp Failure
Low Air Flow	Low Air Flow
Low Air Flow Error	Filter Airflow Error
No-signal	No Signal No Signal is input to the projector. Check the connection status or check that the power for the signal source is turned on.
Power Err. (Ballast)	Power Err. (Ballast)
Sensor error	Sensor Error

A (+) or (-) appears at the start of the message.

(+): A projector problem has occurred

(-): A projector problem has been dealt with

## Management Using SNMP

By setting **SNMP** from the projector's configuration menu, notification messages are sent to preset e-mail addresses when a problem or warning occurs with a projector. This is useful when controlling projectors centrally at a point distant from them. 🖱️ [p.87](#)



- *SNMP should be managed by a network administrator or someone who is familiar with the network.*
- *To use the SNMP function to monitor the projector, you need to install the SNMP manager program on your computer.*
- *The managing function using SNMP cannot be used via wireless LAN in Quick mode.*
- *Up to two destination IP addresses can be saved.*

## Serial Connection

- Connector shape: D-Sub 9-pin (male)
- Projector input port name: **RS-232C**

<At the projector>

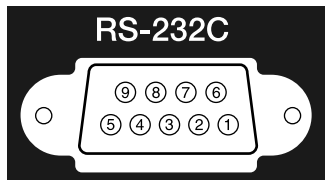

<At the computer>

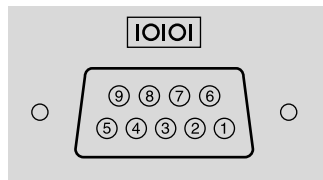

<At the projector>

(PC serial cable)

<At the computer>

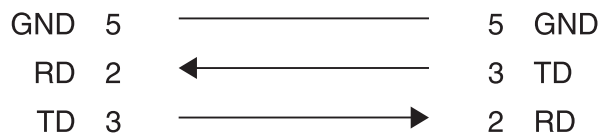

Signal Name	Function
GND	Signal wire ground
TD	Transmit data
RD	Receive data

## Communications Protocol

- Default baud rate setting: 9600 bps
- Data length: 8 bit
- Parity: None
- Stop-bit: 1 bit
- Flow control: None

## Command List

When the power ON command is transmitted to the projector, the power turns on and it enters warm-up mode. When the projector's power has turned on, a colon ":" (3Ah) is returned.

When a command is input, the projector executes the command and returns a ":", and then accepts the next command.

If the command being processed terminates abnormally, an error message is output and a ":" is returned.

Item		Command	
Power ON/OFF	On	PWR ON	
	Off	PWR OFF	
Signal selection	Computer	Auto	SOURCE 1F
		RGB	SOURCE 11
		Component	SOURCE 14
	BNC	Auto	SOURCE BF
		RGB	SOURCE B1
		Component	SOURCE B4
	HDMI1		SOURCE 30
	HDMI2		SOURCE A0
	SDI (PowerLite Pro Z8450WUNL/ Z8455WUNL only)		SOURCE 60
	Video		SOURCE 45
	S-Video		SOURCE 42
LAN		SOURCE 53	
Shutter Button	Electric Shutter/Blank	On	MUTE ON
		Off	MUTE OFF

Add a Carriage Return (CR) code (0Dh) to the end of each command and transmit.



## About PJLink

PJLink Class1 was established by the JBMIA (Japan Business Machine and Information System Industries Association) as a standard protocol for controlling network-compatible projectors as part of their efforts to standardize projector control protocols.

The projector complies with the PJLink Class1 standard established by the JBMIA.

It complies with all commands except for the following commands defined by PJLink Class1, and agreement was confirmed by the PJLink standard adaptability verification.

URL: <http://pjlink.jbmia.or.jp/english/>

- **Non-compatible commands**

Function	PJLink Command
Image muting set	AVMT 11

- **Input names defined by PJLink and corresponding projector sources**

Source	PJLink Command
Computer	INPT 11
BNC	INPT 13
Video	INPT 23
S-Video	INPT 22
HDMI1	INPT 32
HDMI2	INPT 33
SDI (PowerLite Pro Z8450WUNL/Z8455WUNL only)	INPT 34
LAN	INPT 52

- Manufacturer name displayed for "Manufacture name information query"

**EPSON**

- Model name displayed for "Product name information query"

**PL Pro Z8450WU/Z8455WU**

**PL Pro Z8350W**

**PL Pro Z8250/Z8255**

**PL Pro Z8150**

## About Crestron RoomView®

Crestron RoomView® is an integrated control system provided by Crestron®. It can be used to monitor and control multiple devices connected on a network.

The projector supports the control protocol, and can therefore be used in a system built with Crestron RoomView®.

Refer to the Crestron® website for details on Crestron RoomView®. (Only English-language displays are supported.)

<http://www.crestron.com>

An overview of Crestron RoomView® is provided below.

### • Remote operation using a Web browser

A projector can be operated from a computer window just like if you were using a remote control.

### • Monitoring and control with application software

Crestron RoomView® Express or Crestron RoomView® Server Edition provided by Crestron® can be used to monitor devices in the system, to communicate with the help desk, and to send emergency messages. Refer to the following website for details.

<http://www.crestron.com/getroomview>

This manual describes operating procedures in the computer window using a Web browser.



- Only single-byte alphanumeric characters and symbols can be entered.
- The following functions cannot be used while using Crestron RoomView®.  
Web Control  p.129  
Message Broadcasting (EasyMP Monitor plugin)



- Controlling is possible if **Standby Mode** is set to **Communication On** from the **Extended** menu of the projector's configuration menu, even if the projector is in standby state (when the power is off).  p.67

---

## Operating a Projector from a Computer Window

### Displaying the operation window

Confirm the following before performing the procedure.

- Make sure the computer and projector are connected to the network. When communicating with a wireless LAN, connect in Advanced mode.  p.74
- Set **Crestron RoomView** to **On** on the **Administrator Settings** menu under the **Network** menu. Changes in projector settings take effect upon restarting.  p.82

### Procedure



**Start the Web browser on the computer.**



**Enter the IP address of the projector in the address field of the Web browser, and press the [Enter] key on the keyboard.**

The operation window will be displayed.

## Using the operation window

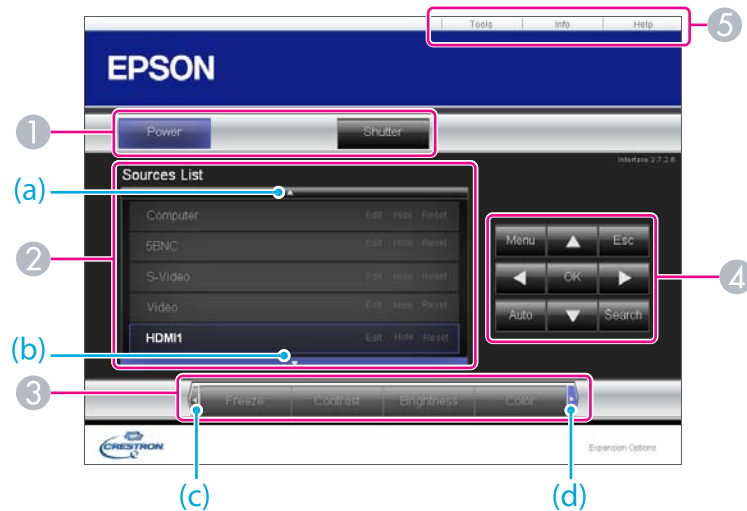

1 The following operations will be performed when the buttons are clicked.

Button	Function
<b>Power</b>	Turns the projector power on or off.
<b>Shutter</b>	You can use this when you want to focus the audience's attention on what you are saying, or if you do not want to show details such as when you are changing between files during presentations from a computer. <a href="#">p.39</a>

\* This projector does not support the control of audio.



2 Switch to the image from the selected input source. To display input sources that are not shown in the window, click (a) or (b) to scroll up or down. The source name can be changed optionally.

3 The following operations will be performed when the buttons are clicked. To display buttons that are not shown in the window, click (c) or (d) to scroll left or right.

Button	Function
<b>Freeze</b>	Images are paused or unpaused. <a href="#">p.39</a>
<b>Contrast</b>	Adjusts the difference between light and dark areas in the image.
<b>Brightness</b>	Adjusts the image brightness.
<b>Color</b>	Adjusts the color saturation for the images.
<b>Sharpness</b>	Adjusts the image sharpness.
<b>Zoom</b>	Click the [⊕] button to enlarge the image without changing the projection size. Click the [⊖] button to reduce an image that was enlarged with the [⊕] button. Click the [▲], [▼], [◀], or [▶] button to change the position of an enlarged image. <a href="#">p.41</a>

4 Clicking the [▲], [▼], [◀], or [▶] button performs the same operation as the [⊕] button on the remote control. The following operations will be performed when the other buttons are clicked.

Button	Function
<b>OK</b>	Performs the same operation as the [Enter] button on the remote control. <a href="#">p.19</a>
<b>Menu</b>	Displays and closes the configuration menu.

Button	Function
<b>Auto</b>	If clicked when a computer analog RGB signal is being projected, automatically optimizes the image by adjusting the Tracking, Sync., and Zoom Position.
<b>Search</b>	Switches to the image from the input port where video signals are being input.  <a href="#">p.25</a>
<b>Esc</b>	Performs the same operation as the [Esc] button on the remote control.  <a href="#">p.19</a>

5 The following operations will be performed when the tabs are clicked.

Tab	Function
<b>Contact IT Help</b>	Displays the Help Desk window. Used to send and receive messages to the administrator using Crestron RoomView® Express.
<b>Info</b>	Displays information on the projector that is currently connected.
<b>Tools</b>	Changes the settings in the projector that is currently connected. Refer to the next section.

## Using the tools window

The following window will be displayed if the **Tools** tab is clicked in the operation window. This window is used to change the settings in the projector that is currently connected.

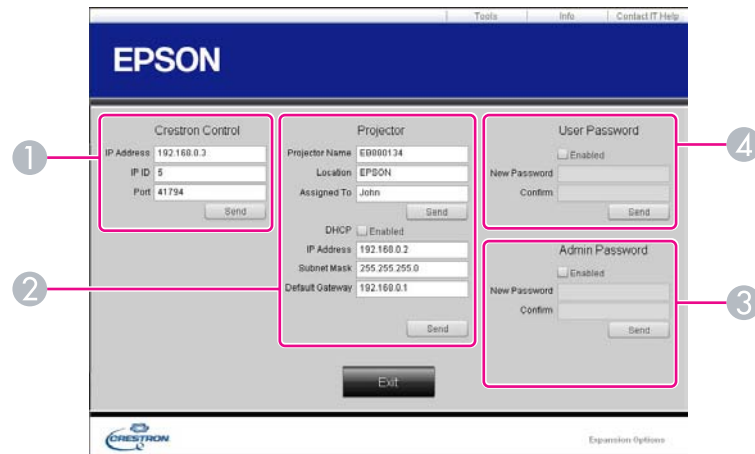

**1 Crestron Control**  
Makes settings for Crestron® central controllers.

**2 Projector**  
The following items can be set.

Item	Function
<b>Projector Name</b>	Enter a name to differentiate the projector that is currently connected from other projectors on the network. (The name can contain up to 15 single-byte alphanumeric characters.)

Item	Function
<b>Location</b>	Enter an installation location name for the projector that is currently connected on the network. (The name can contain up to 32 single-byte alphanumeric characters and symbols.)
<b>Assigned To</b>	Enter a user name for the projector. (The name can contain up to 32 single-byte alphanumeric characters and symbols.)
<b>DHCP</b>	Select the <b>Enabled</b> check box to use DHCP. You cannot set static IP addresses if DHCP is enabled.
<b>IP Address</b>	Enter the IP address to assign to the currently connected projector.
<b>Subnet Mask</b>	Enter a subnet mask for the projector that is currently connected on the network.
<b>Default Gateway</b>	Enter the gateway address for the currently connected projector.
<b>Send</b>	Click this button to commit changes made to the <b>Projector</b> .

### 3 Admin Password

Select the **Enabled** check box to require a password to open the Tools window.

The following items can be set.

Item	Function
<b>New Password</b>	Enter the new password required to open the Tools window. (The password can contain up to 26 single-byte alphanumeric characters.)
<b>Confirm</b>	Enter the same password you entered in <b>New Password</b> . If the passwords are not the same, an error will be displayed.
<b>Send</b>	Click this button to commit changes made to the <b>Admin Password</b> .

### 4 User Password

Select the **Enabled** check box to require a password to open the operation window on the computer.

The following items can be set.

Item	Function
<b>New Password</b>	Enter the new password required to open the operation window. (The password can contain up to 26 single-byte alphanumeric characters.)
<b>Confirm</b>	Enter the same password you entered in <b>New Password</b> . If the passwords are not the same, an error will be displayed.
<b>Send</b>	Click this button to commit changes made to <b>User Password</b> .

## About Message Broadcasting

Message Broadcasting is plugin software for EasyMP Monitor.

Message Broadcasting can be used to send a message (JPEG file) to project on all Epson projectors or specified projectors connected on the network.

The data can be sent manually, or sent automatically using Timer Settings of EasyMP Monitor.

Download the Message Broadcasting software from the following website.

<http://www.epson.com>

# Network Functions

This chapter explains the additional functions for networks.



## Projecting with "Connect to a Network Projector"

"Connect to a Network Projector" is a standard function in Windows Vista and Windows 7. You can project images from the computer by detecting the projector on the network using a function of the OS without having to install any special software.

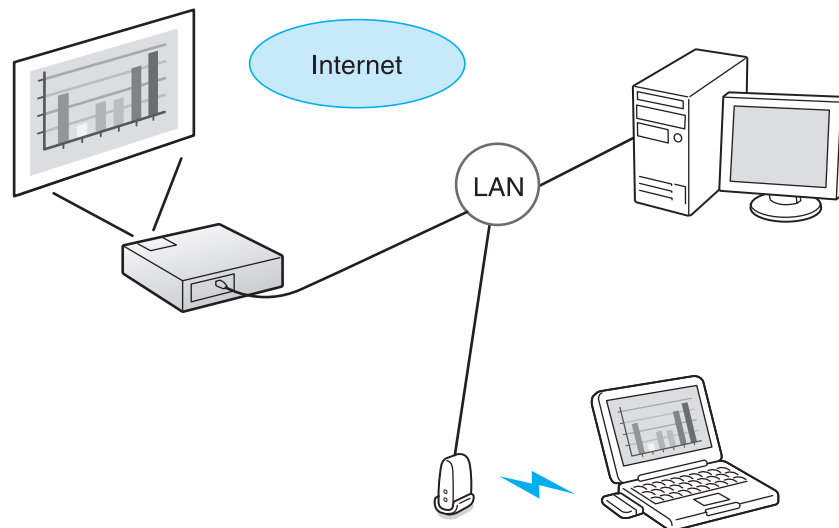

Compatible OS
Windows Vista: Home Premium/Business/Enterprise/Ultimate
Windows 7: Professional/Ultimate

This section provides an easy explanation of "Connect to a Network Projector".

Check that the projector and computer are connected to the network, and carry out the following operations.

## Procedure

- 1 Turn the projector on and switch the input source to LAN.  
☛ "Changing the Projected Image" p.25
- 2 On the computer, start Windows, and then click "Start" - "All programs" - "Accessories" - "Connect to a Network Projector".
- 3 Once the OS has identified all of the connected projectors, select the one that you want to use and click "Connect".

The connection setting screen is displayed.

The projector is identified by inputting its IP address, or by allowing the OS to automatically identify all of the connected projectors.

When the projector password screen is displayed, enter the key-word shown at the bottom of the LAN standby screen.



- You can connect only one projector to a computer.
- When using Network Projector from Options in Windows Meeting Space, set the colors for the computer screen you are using to the highest level (32bit). If it is not capable of a 32bit display, a message is displayed and you cannot connect.

## Making a WPS (Wi-Fi Protected Setup) Connection with a Wireless LAN Access Point

There are two methods for setting WPS▶▶.

- Push Button Method

SSID and security are set automatically when the [Enter] button is pressed on the projector's control panel and the dedicated button on the access point equipment. This method is recommended when the projector and access point are close together.

- PIN Code Method

SSID and security are set automatically by inputting an 8-digit code that was assigned to the projector from the computer to the access point in advance. Make connection settings between the computer and the access point in advance. For details on how to make this connection, refer to the manual provided with the access point. This method is recommended when the projector is mounted on the ceiling.



Refer to the documentation for the access point device and to the following section when using any connection method other than WPS. 🖱️ "Wireless LAN Menu" [p.74](#)

## Connection Setup Method

### Procedure



**During projection, press the [Menu] button and select "Network" - "Network Configuration" from the configuration menu.**

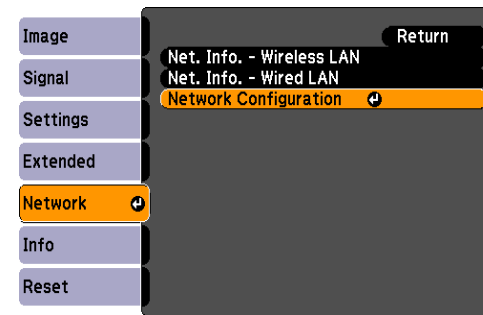

The Network Configuration screen is displayed.

2 From "Wireless LAN" select "To Setup Wizard".



The following screen is displayed.

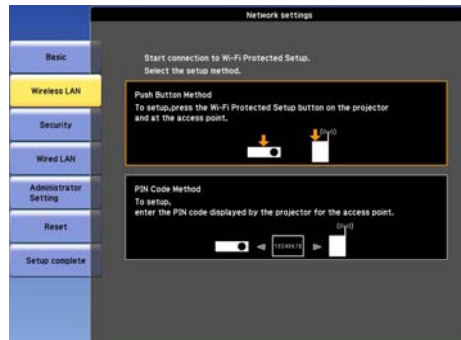

When connecting using the Push Button Method, follow the steps given below.

Go to "Making a connection using the PIN Code Method" when connecting using the PIN Code Method.  [p.148](#)

## Making a connection using the push button method

### Procedure

1 Select "Push Button Method".

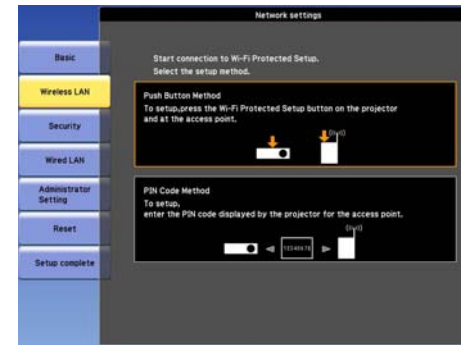

The "Push Button Method" screen is displayed.

- 2 Press the [Enter] button on the projector's control panel when prompted by the screen.



The "Push Button Method" screen is displayed.

- 3 Press the button on the access point when prompted by the screen.



This completes the setup.

- 4 Press the [Enter] button or the [Esc] button. It returns to the Wireless LAN menu screen.

- 5 Select "Setup complete" - "Yes."

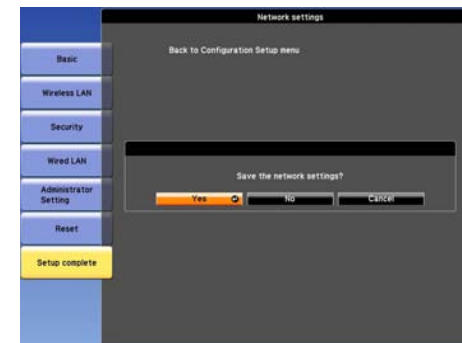

This completes the setup of the connection between the projector and the access point. Press the [Menu] button to close the configuration menu.

## Making a connection using the PIN Code Method



Before you can make a connection using the PIN Code Method, a connection must have already been setup between the computer and the access point.

## Procedure

- 1 Select "PIN Code Method".

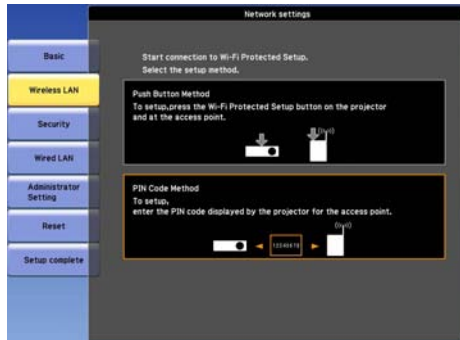

The "PIN Code Method" screen is displayed.

- 2 Enter the PIN code displayed on the "PIN Code Method" screen from the computer to the access point, and then select "Start Setup".

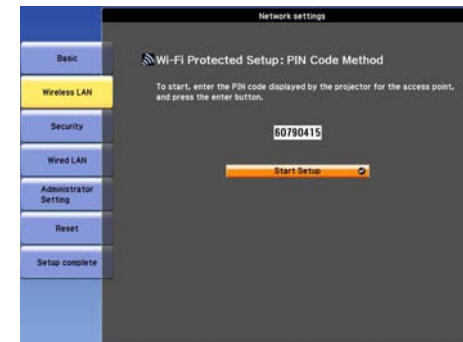

The progress is displayed.



- 3 The message "Setup by Wi-Fi Protected Setup complete." is displayed. Press the [Enter] button or the [Esc] button.

It returns to the Wireless LAN menu screen.

**4** Select "Setup complete" - "Yes."



This completes the setup of the connection between the projector and the access point. Press the [Menu] button to close the configuration menu.

# Installation and Connections

This chapter explains the projection installation methods and methods to connect to other equipment.

## Installation Methods

The projector can be mounted on a ceiling or placed on a desk. Also, it can be mounted at a tilted angle, so you can flexibly project images to various places.

### Warning

- A special method of installation is required when suspending the projector from a ceiling (ceiling mount). If installation work is not carried out correctly, the projector could fall down. This may result in injury or accidents.
- If you use adhesives on the ceiling mount attachment points to prevent the screws from loosening, or if you use things such as lubricants or oils on the projector, the projector case may crack causing it to fall from its ceiling mount. This could cause serious injury to anyone under the ceiling mount and could damage the projector. When installing or adjusting the ceiling mount, do not use adhesives to prevent the screws from loosening and do not use oils or lubricants.
- When mounting the projector on the ceiling, be sure to take measures to prevent it from falling such as passing a wire through the handles.

### Caution

- Do not use the projector upside down.
- Set the Direction properly in the configuration menu according to the angle of installation.  [p.67](#)
- Using the projector at an improper angle or setting the configuration menu incorrectly can cause malfunctions and shorten the operating life of optical parts.

- Suspend the projector from the ceiling and project images from in front of a screen.

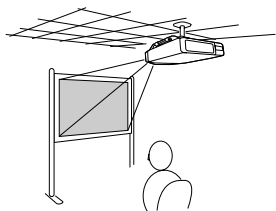

- Suspend the projector from the ceiling and project images from behind a translucent screen.

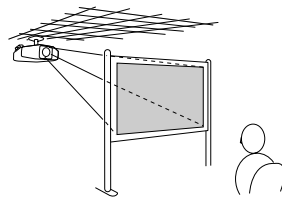

- Project images from in front of a screen.

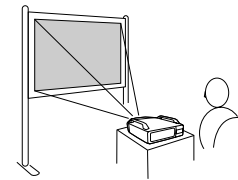

- Project images from behind a translucent screen.

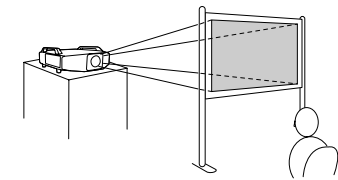

- Project images directly up

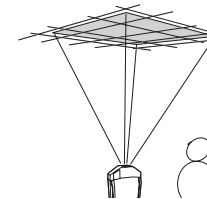

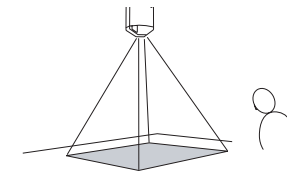

- Project images directly down

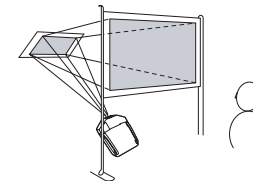

- Project images at angle



- An optional ceiling mount is required when suspending the projector from a ceiling.  "Optional Accessories and Consumables" [p.197](#)
- The Projection setting can be changed from the configuration menu.  [p.67](#)



When installing the projector, keep enough distance from the wall to the projector's air exhaust and intake vent.

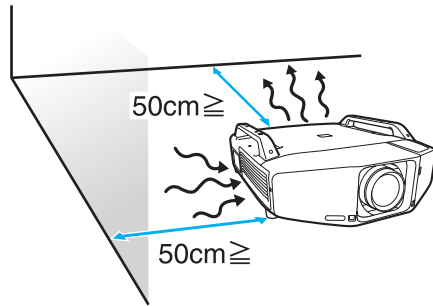

## Connecting to Equipment

Observe the following precautions when connecting the projector to external equipment. Be sure to also read the documentation for the external equipment.

### Caution

- Turn off the projector and the external equipment. The projector or external equipment may fail if they are connected while the power is on.
- Check the shapes of the cable connector and port before connecting them. If connecting them is attempted in the wrong direction or when they do not match, failure or equipment damage may occur.

Remove the interface cover before connecting external equipment. 🖱️ "Attaching and Removing the Interface Cover" [p.193](#)

## Connecting to a Computer

This section provides examples of connecting the projector to a computer. The computer port and cable names may also be different from those given.





Refer to the following when projecting images from a computer that is connected through a network.

Projecting with the EasyMP Network Projection application software (provided with the projector). See your *EasyMP Network Projection Operation Guide* for more information.

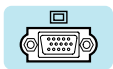
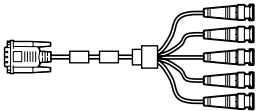
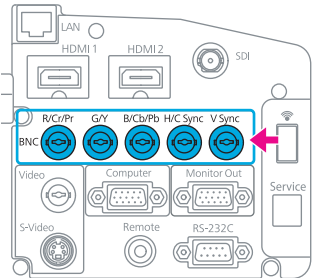
Projecting with the "Connect to a Network Projector" function provided with Windows Vista or Windows 7 🖱️ [p.145](#)

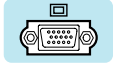
	Computer port	Connecting cable	Projector port
Connection 1	Monitor Out port 	5BNC display cable (commercially available) 	BNC input port 

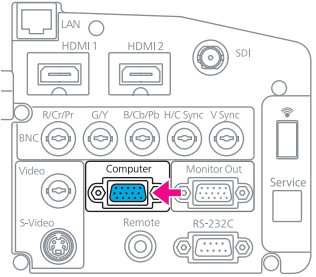
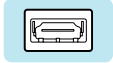
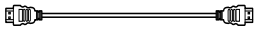
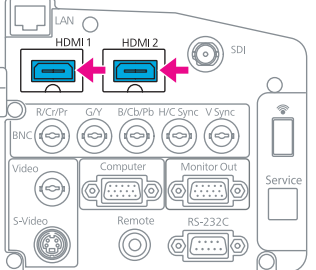
	Computer port	Connecting cable	Projector port
Connection 2	Monitor Out port 	Computer cable (supplied) 	Computer input port 
Connection 3	HDMI output 	HDMI cable (commercially available) 	HDMI1/2 input port 



Use a cable that complies with the HDMI standard for the HDMI cable.

## Changing the video output from a laptop computer.



When projecting images from a laptop computer connected to the projector with a computer cable, the output for the video signal must be changed at the computer. Refer to the documentation for your computer for the method to change the video output.



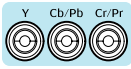
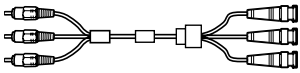
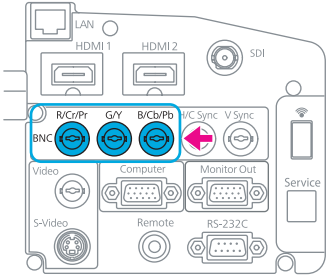

- **Example of changing the output (Windows computers)**

Hold down the Fn key on your computer and press the function key labeled CRT/LCD, , etc. If the image is not displayed on your computer monitor, press the same keys again.

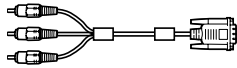
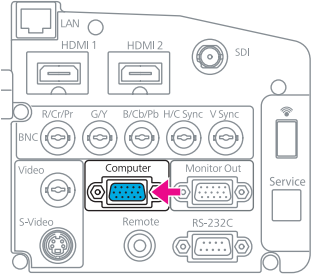
## Connecting to Video Equipment

This section provides examples of connecting the projector to video equipment. The video equipment port and cable names may also be different from those given.

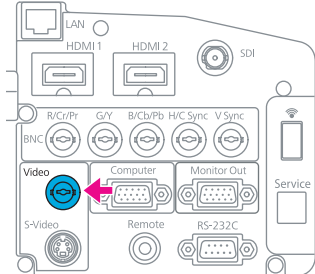
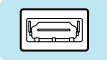
	Port on the video equipment	Connecting cable	Projector port
Connection 1	Component outputs 	RCA component video cable (commercially available) + BNC/RCA adapter (commercially available) 	BNC input port (R/Cr/Pr, G/Y, B/Cb/Pb) 
Connection 2	Component outputs 	Component-to-VGA cable (D-sub/component conversion) (optional accessory) 	Computer input port 

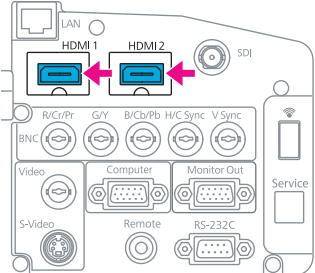
	Port on the video equipment	Connecting cable	Projector port
Connection 3	<p>S-Video output</p> 	<p>S-Video cable (commercially available)</p> 	<p>S-Video input port</p> 
Connection 4	<p>Video output</p> 	<p>BNC video cable (commercially available)</p> 	<p>Video input port</p> 
Connection 5	<p>HDMI output</p> 	<p>HDMI cable (commercially available)</p> 	<p>HDMI1/2 input port</p> 

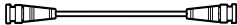
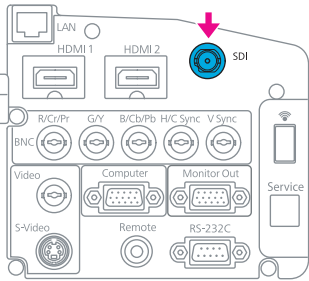
	Port on the video equipment	Connecting cable	Projector port
Connection 6*	SDI output 	BNC video cable (commercially available) 	SDI input port 

\* PowerLite Pro Z8450WUNL/Z8455WUNL only



- Set the Input Signal and Video Signal on the Signal menu according to the signal from the connected equipment.  p.62
- Use a cable that complies with the HDMI standard for the HDMI cable.

## Adjusting the Projected Image

### Displaying a Test Pattern

A test pattern can be displayed to adjust the projected image without connecting video equipment. This is useful when installing a projector.



If the [User] button on the remote control is set to **Test Pattern**, the test pattern will be displayed when the [User] button is pressed. (The default setting is Test Pattern.)

#### Procedure

- 1 During projection, press the [Menu] button. Select Settings - "Test Pattern", then press the [Enter] button.

Using the Remote Control

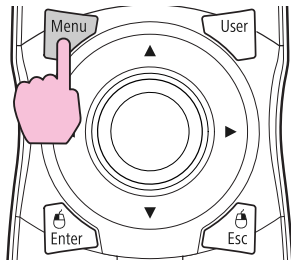

Using the Control Panel

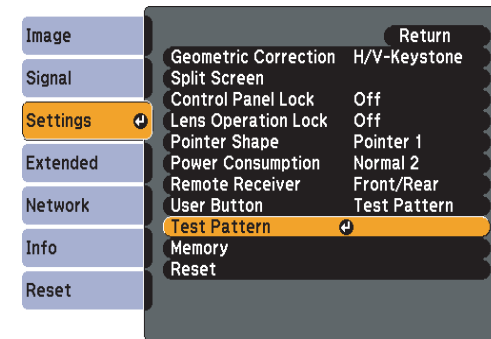
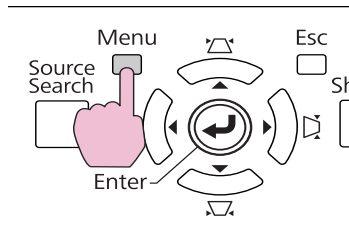

**2** Press the [⊙] button on the remote control in the [▶] direction or press the [Enter] button on the control panel to switch the test pattern.

To display the previous image, press the [⊙] button on the remote control in the [◀] direction.

### Using the Remote Control

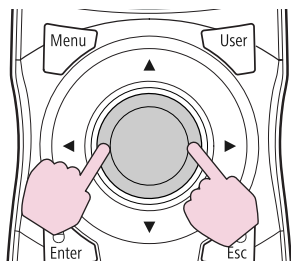

### Using the Control Panel

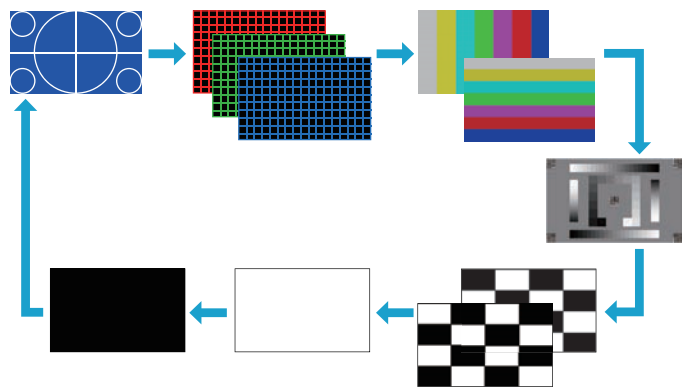
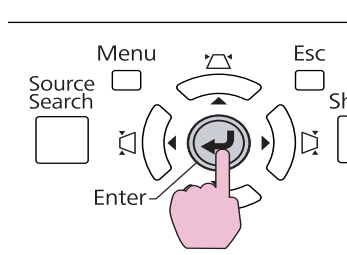

The following adjustments can be made while the test pattern is being displayed.

Top Menu	Sub Menu/Items
Image menu	Color Mode  p.34
	Abs. Color Temp.
	Advanced
	- Gamma*1  p.171
	- RGB - RGBCMY  p.171
	Auto Iris
	Reset
Signal menu	Auto Setup
Settings menu	Geometric Correction  p.163
Extended menu	Multi-Projection
	- Brightness Level*2
	- Edge Blending  p.180 - Multi-screen  p.182

\*1 Except for custom settings of gamma

\*2 Not available on PowerLite Pro Z8150NL



To set menu items that cannot be set while the test pattern is being displayed or to fine-tune the projected image, project an image from the connected device.



**3** Press the [Esc] button to end the test pattern.



## Adjusting the Position of the Projected Image (Lens Shift)

The lens can be shifted to adjust the position of the projected image, for example, when the projector cannot be installed directly in front of the screen.

### Procedure

- 1 Press the [Lens Shift] button on the remote control. When using the control panel of the projector, press the [Lens] button three times.

#### Using the Remote Control

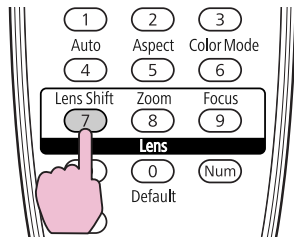

#### Using the Control Panel

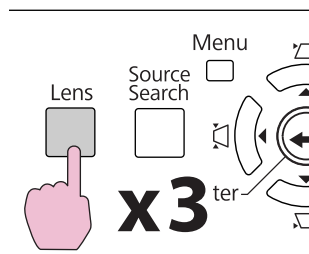

- 2 To adjust the position of the projected image, use the [⊙] button on the remote control or the [↔/↕], [↖/↘], [↗/↙], and [↠/↞] buttons on the control panel.

#### Using the Remote Control

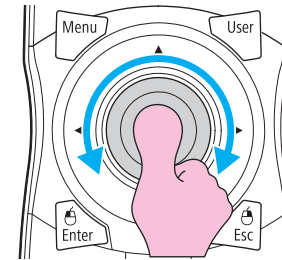

#### Using the Control Panel

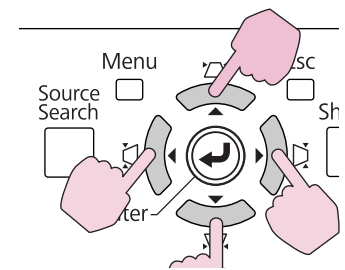

Keep pressing the button to move the image continuously.

When the position of the lens shift comes to the center of the vertical or horizontal direction, it stops moving. Release your finger and press the button again to adjust more.



The image will be clearest when both the vertical and horizontal lens shift are set in the center.

The ranges within which the image can be moved are shown below.

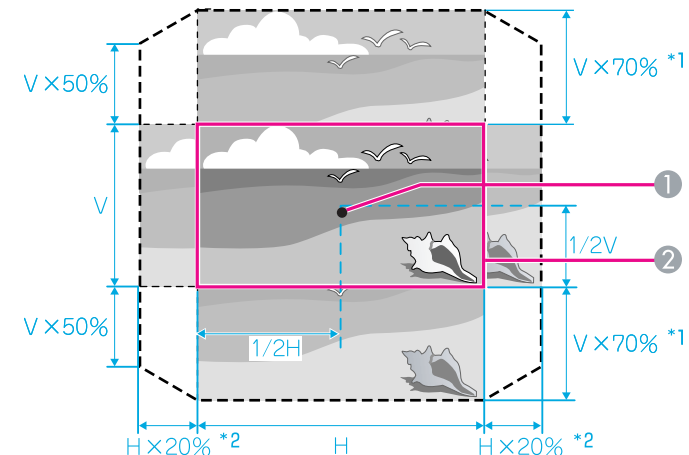

\*1 PowerLite Pro Z8150NL/Z8250NL/Z8255NL: V x 56%

\*2 PowerLite Pro Z8150NL/Z8250NL/Z8255NL: H x 6%

- ① Center of lens
- ② Projected image when lens shift is set in the center

The position of the projected image cannot be moved to both the horizontal and vertical maximum value.

Example: When the image is moved to the maximum value horizontally, the image can be moved up to 50% vertically. When the image is moved to the maximum value vertically, the image cannot be moved horizontally.

- ② To adjust the focus, use the [Focus] button on the remote control or the arrow buttons on the back of the projector as shown below.

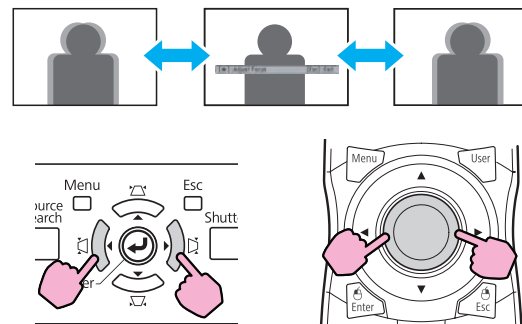

- ③ When you're done, press the [Esc] button on the remote control or on the back of the projector.

## Focusing the Image

### Procedure

- ① Press the [Focus] button on the remote control or press the [Lens] button on the back of the projector until "Adjust Focus" is displayed on the screen.

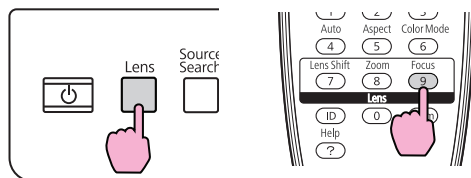

## Zooming the Image

### Procedure

- ① Press the [Zoom] button on the remote control or press the [Lens] button on the back of the projector until "Adjust Zoom" is displayed on the screen.

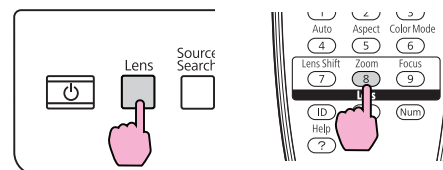

**2** To zoom, use the [⊙] button on the remote control or the arrow buttons on the back of the projector as shown below.

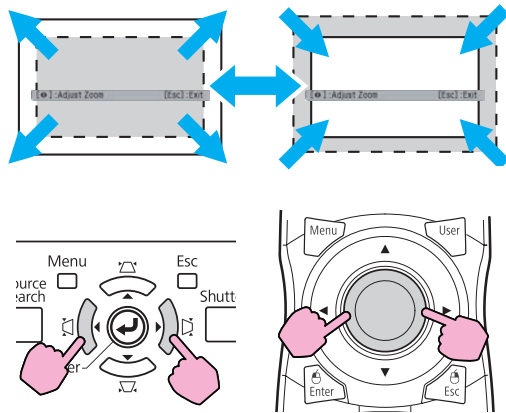

**3** When you're done, press the [Esc] button on the remote control or on the back of the projector.

## Adjusting the Tilt of the Projected Image

When setting up on a desk, adjust the horizontal tilt of the projector with its front and rear feet.

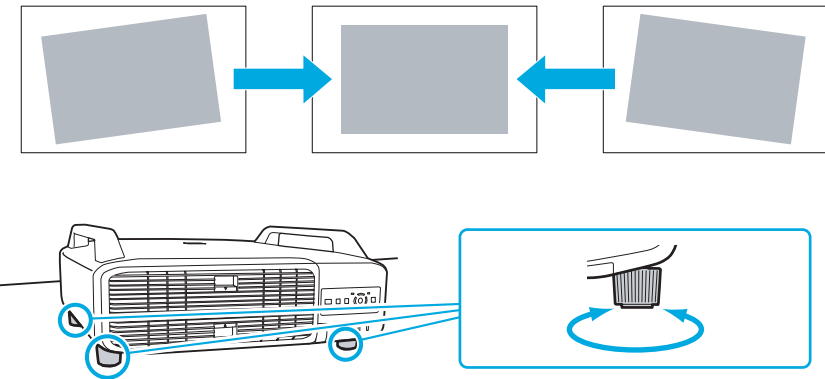

## Correcting Distortion in the Projected Image

There are four methods of correcting distortion in projected images as below.

- **Quick Corner**  
This allows you to manually correct each of the four corners of the projected image separately. 🖱️ "Quick Corner" [p.164](#)  
We recommend using Quick Corner to accurately adjust keystone distortion.
- **H/V-Keystone**  
This allows you to manually correct distortion in the horizontal and vertical directions independently. You can perform easy H/V-Keystone corrections by using the [↖/↗] [↘/↙] [↵/↶] and [↷/↸] buttons on the projector's control panel. 🖱️ "H/V-Keystone" [p.166](#)
- **Arc Correction**  
Fine adjustment of the curved distortion caused by slack or shrinkage of the screen. 🖱️ "Arc Correction" [p.168](#)

- Point Correction

Corrects slight distortion which occurs partially, or adjusts the screen position in an overlapping area when projecting from multiple projectors. (☞ "Point Correction" p.178)

Quick Corner, H/V-Keystone, Arc Correction, and Point Correction cannot be performed at the same time. Select the correction method from **Geometric Correction** in the configuration menu. The default setting for **Geometric Correction** is set to **H/V-Keystone**, so when [ $\nabla$ / $\blacktriangle$ ], [ $\swarrow$ / $\searrow$ ], [ $\leftarrow$ / $\rightarrow$ ], and [ $\uparrow$ / $\downarrow$ ] buttons are pressed, H/V-Keystone correction is carried out.

Because Quick Corner, H/V-Keystone, Arc Correction, and Point Correction can be carried out while projecting a test pattern, you do not need to make preparations by connecting a computer or other equipment.

## Quick Corner

### Procedure



**During projection, press the [Menu] button. Select Settings menu - "Geometric Correction" and then press the [Enter] button.** (☞ "Using the Configuration Menu" p.55)

Using the Remote Control

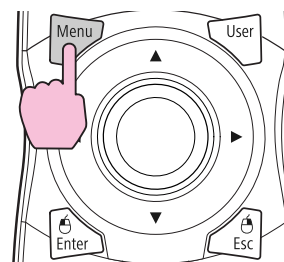

Using the Control Panel

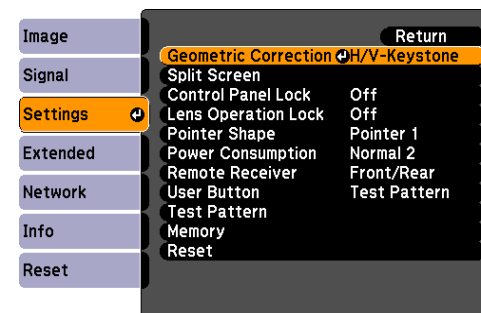
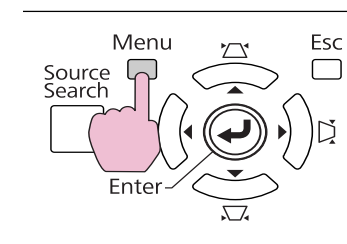

**2** Select "Quick Corner", and then press the Enter button.

Press the [Enter] button again to display the selection screen from which you can select one of the four corners.

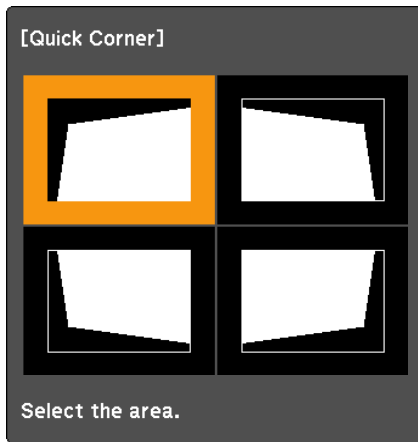

[↔/↔]: Select  
[Enter] : Enter  
[Esc] : Return (press for 2 seconds to reset)

**3** Use the [⊙] button on the remote control or the [△/▲], [▽/▼], [◀/◀], and [▶/▶] buttons on the control panel to select the corner you want to adjust, and then press the [Enter] button.

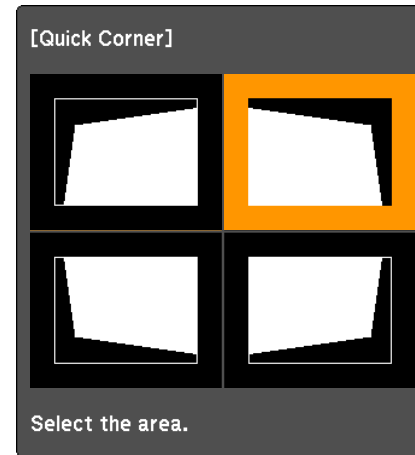

- 4 To adjust the shape, use the [⊙] button on the remote control or the [↖/↗], [↘/↙], [↵/↔], and [↞/↠] buttons on the control panel.

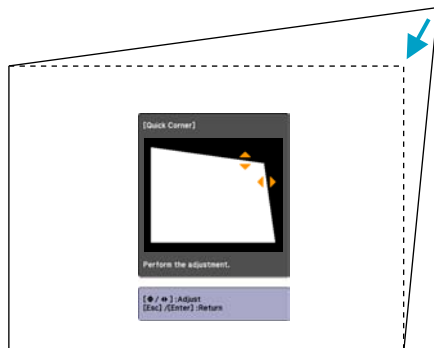

If the triangle in the direction you are adjusting the shape turns gray, as shown in the screenshot below, you cannot adjust the shape any further in that direction.

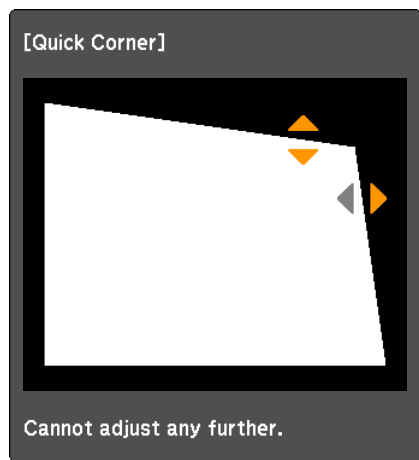

- 5 Repeat steps 3 and 4 as needed to adjust any remaining corners.
- 6 When you are done, press the [Esc] button to exit the correction menu.

Because the correction method was changed to **Quick Corner** from **Geometric Correction** in the configuration menu, when [↖/↗], [↘/↙], [↵/↔], and [↞/↠] buttons are pressed later, the screen for selecting the corner in step 2 is displayed. Change **Geometric Correction** from the configuration menu to **H/V-Keystone** if you want to correct H/V-Keystone when pressing the [↖/↗], [↘/↙], [↵/↔], and [↞/↠] buttons on the control panel. [☞ p.65](#)



If the [Esc] button is held down for about two seconds while correcting with Quick Corner, the confirm default reset screen is displayed. Select "Yes" to reset the result of Quick Corner corrections.

## H/V-Keystone

### Procedure

Press the [↖/↗], [↘/↙], [↵/↔], and [↞/↠] buttons on the control panel to adjust keystone settings in the horizontal and vertical directions independently.



This adjustment can also be made from **Geometric Correction - H/V-Keystone** on the **Settings** menu. [☞ p.65](#)

- Correcting vertical keystone

Vertical keystone can be corrected to a vertical projector tilt of up to 30° against the screen.

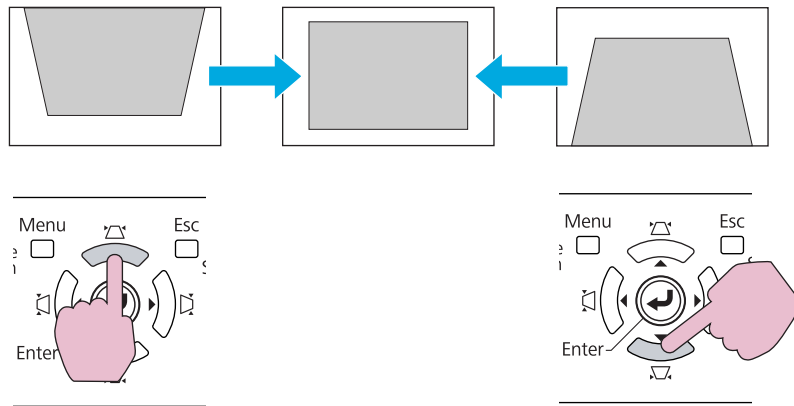

If the [↑/↓] and [←/→] buttons are pressed simultaneously for at least 1 second, the results of any vertical keystone correction will be reset.

- Correcting horizontal keystone

Horizontal keystone can be corrected to a horizontal projector tilt of up to 20° against the screen.

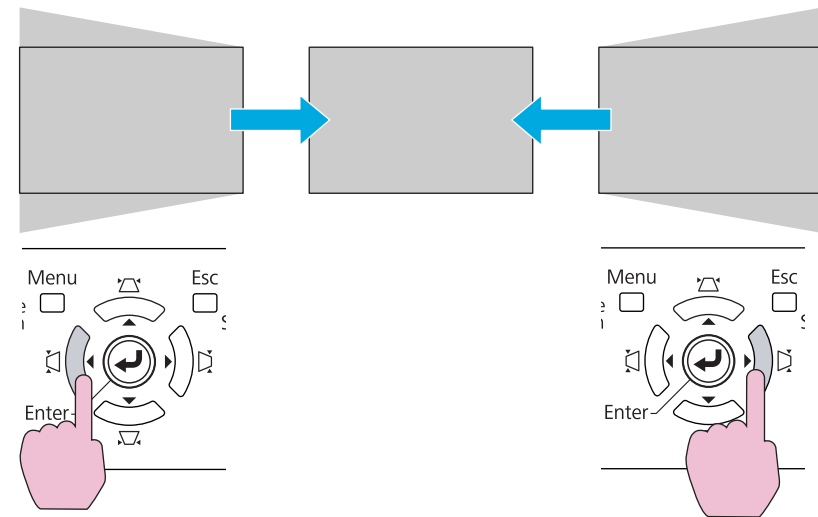

If the [←/→] and [↑/↓] buttons are pressed simultaneously for at least 1 second, the results of any horizontal keystone correction will be reset.



Before performing horizontal or vertical keystone adjustment, shift the lens to the positions mentioned below. Otherwise, your image may not be adjusted correctly. 🖱️ "Adjusting the Position of the Projected Image (Lens Shift)" [p.161](#)

- The horizontal lens shift is set to the center.

- The vertical lens shift is set to the top or bottom.

The correction may not be properly performed for some zoom settings. And, the projected screen size may become smaller after performing the correction. Be careful about the projection distance when installing the projector.

Correct the image using Quick Corner to precisely align the projected image with the screen or to fine-tune the image. 🖱️ "Quick Corner" p.164

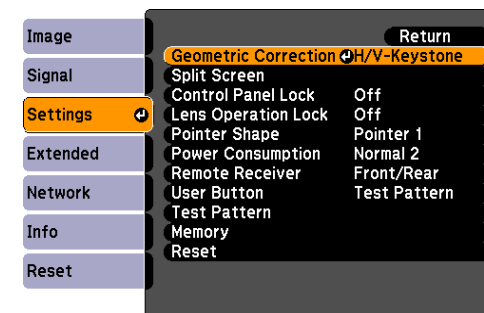

## Arc Correction

### Procedure

- 1 During projection, press the Menu button. Select Settings menu - "Geometric Correction" and then press the Enter button. 🖱️ "Using the Configuration Menu" p.55

Using the Remote Control

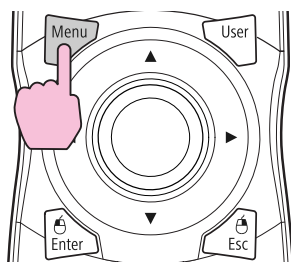

Using the Control Panel

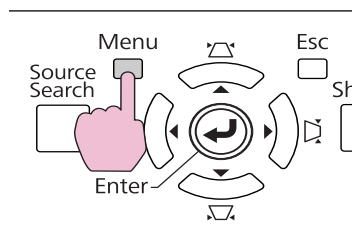

- 2 Select "Arc Correction" and press the [Enter] button.

Press the [Enter] button again, and the screen below appears, so you can select one of the 8 vertical/horizontal areas and corners.

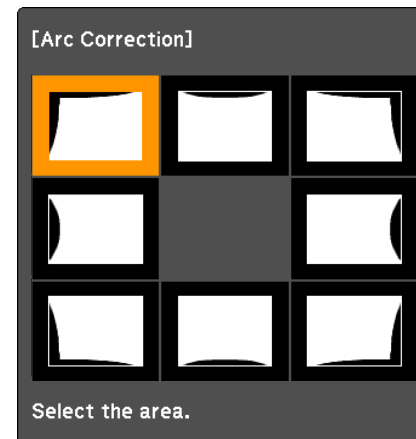

[◀/▶]: Select  
 [Enter] : Enter  
 [Esc] : Return (press for 2 seconds to reset)



- 3** Use the [⊙] button on the remote control or the [△/▲], [▽/▼], [◀/◂], and [▶/▸] buttons on the control panel to select the area you want to adjust, and then press the [Enter] button.

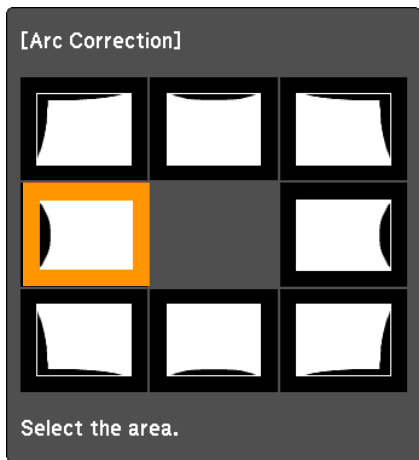

When selecting a corner, you can adjust the two sides next to the corner.

- 4** To adjust the shape, use the [⊙] button on the remote control or the [△/▲], [▽/▼], [◀/◂], and [▶/▸] buttons on the control panel.

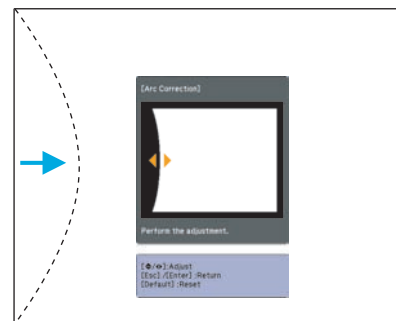

If the triangle in the direction you are adjusting the shape turns gray, as shown in the screenshot below, you cannot adjust the shape any further in that direction.



If you press the [Default] button while adjusting, the value that you are adjusting is reset to the default.

- 5 Press the [Esc] button to return to the previous screen.
- 6 Repeat steps 3 to 5 as needed to adjust any remaining parts.
- 7 When you are done, press the [Esc] button to exit the correction menu.



If the [Esc] button is held down for about two seconds while correcting with Arc Correction, the following screen is displayed.

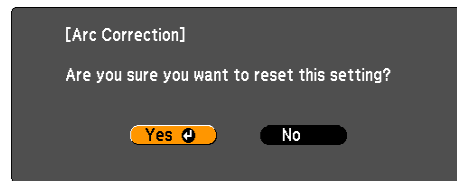

Select "Yes" to reset the results of any Arc Correction adjustments.

## Adjusting the Image Quality

### Hue, Saturation, and Brightness Adjustment

The Hue, Saturation, and Brightness for each of the R (red), G (green), B (blue), C (cyan), M (magenta) and Y (yellow) color components can be adjusted.

The menu is displayed in the following order.  
Image menu - Advanced - RGBCMY

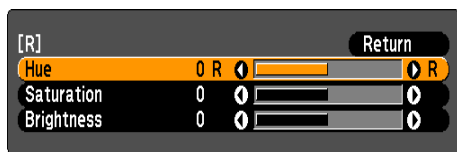

<b>Hue</b>	Adjusts the overall hue of the image, bluish – greenish – reddish.
<b>Saturation</b>	Adjusts the overall vividness of the image.
<b>Brightness</b>	Adjusts the overall color brightness of the image.



If you press the [Default] button while adjusting, the value that you are adjusting is reset to the default.

### Gamma Adjustment

Before are three ways the gamma setting in the configuration menu can be adjusted.

Method	Menu
Select and adjust the correction value	<b>Image - Advanced - Gamma</b>
Adjust while viewing the image	<b>Image - Advanced - Gamma - Customized - Adjust it from the image</b>
Adjust using the gamma adjustment graph	<b>Image - Advanced - Gamma - Customized - Adjust it from the graph</b>

### Select and adjust the correction value

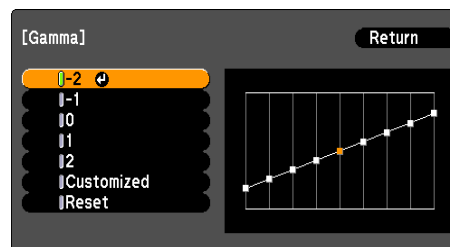

When a smaller value is selected, the dark areas of images become brighter, but the lighter areas may become oversaturated. When a larger value is selected, you can reduce the overall brightness of the image to make the image sharper.



The gamma graph's horizontal axis represents the input signal level and its vertical axis represents the output signal level.

When **Color Mode** is set to **DICOM SIM** from the Image menu, select the correction value based on your screen size in reference to a 150 inch screen.

If your screen is smaller than 150 inches, select a large value. If your screen is larger than 150 inches, select a small value.



Medical images may not be reproduced correctly according to your settings and screen specifications.

## Adjust while viewing the image

Move the cursor on the projected image to the part where you want to change the brightness, and adjust the value.

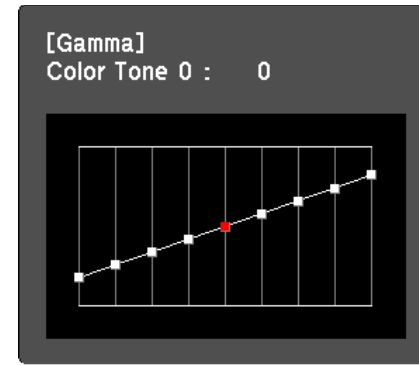
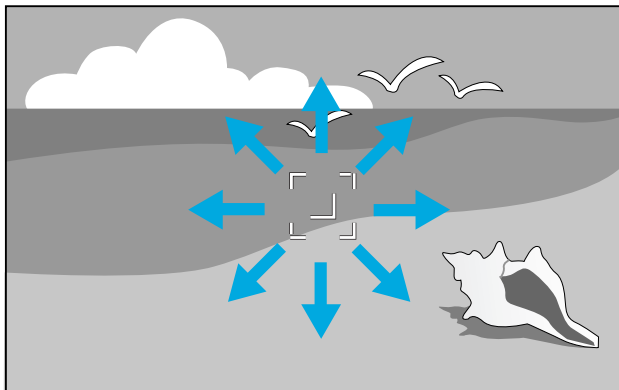

If you press the [Default] button while adjusting, the value that you are adjusting is reset to the default.

## Adjust using the gamma adjustment graph

Adjust while looking at the gamma adjustment graph.

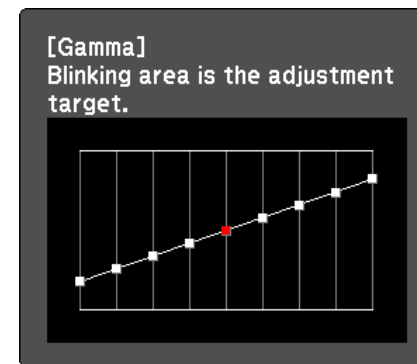

If you press the [Default] button while adjusting, the value that you are adjusting is reset to the default.

## Frame Interpolation (PowerLite Pro Z8450WUNL/Z8455WUNL only)

The current and previous frames are used to create intermediate frames which help to produce smooth-moving images. You can resolve clumsy-moving images, such as frames skipping when projecting a fast moving image.

The menu is displayed in the following order.  
Signal Menu - Frame Interpolation

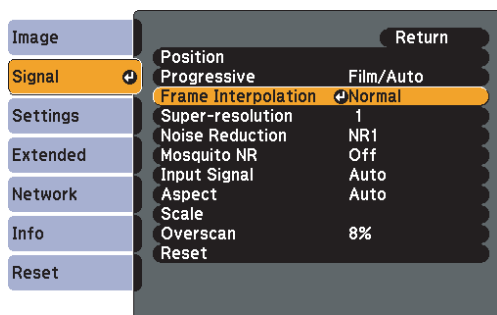

You can select the level of interpolation: **Low**, **Normal** or **High**. Set to **Off** if noise occurs after setting them.

## Super-resolution

You can sharpen the image of a low resolution or blurry picture.

The menu is displayed in the following order.  
Signal Menu - Super-resolution

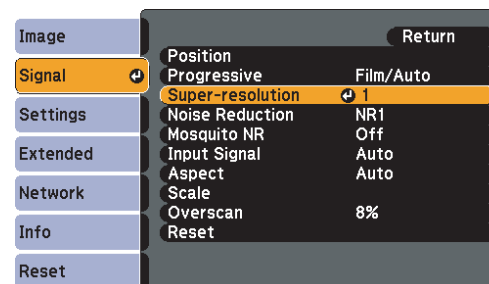

Depending on the image, distortion at the edge of the image may be enhanced. If you notice any distortion, set it to "0".



If you press the [Default] button while adjusting, the value that you are adjusting is reset to the default.

## Noise Reduction

There are two kinds of noise reduction functions:

- Noise Reduction
- Mosquito NR

## Noise Reduction

You can make settings related to Noise Reduction (reduce flickering of images).

The menu is displayed in the following order.  
Signal Menu - Noise Reduction

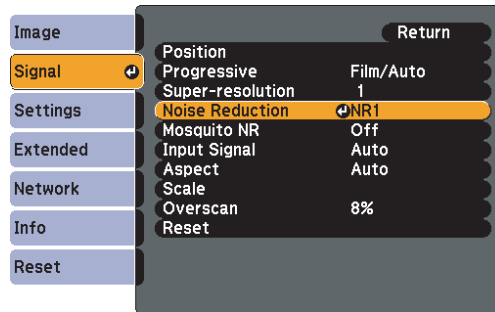

It is recommended that this is set to **Off** when viewing image sources in which noise is very low, such as for DVDs.

## Mosquito NR

You can reduce the wavy noise that occurs in lines between areas with dramatic changes in colors.

The menu is displayed in the following order.  
Signal Menu - Mosquito NR

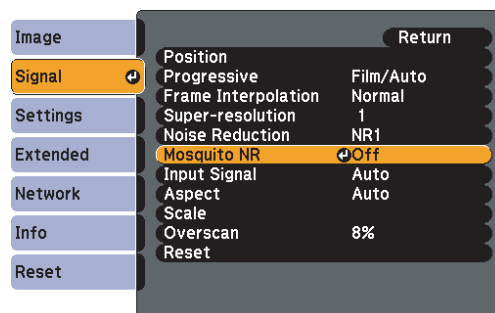

## Settings for Multiple Projectors

When projecting to a wide screen from multiple projectors, you can adjust the difference of brightness and color tone between the edges of each projected image (Edge Blending), to create a seamless screen.

There are two general methods of projecting from multiple projectors.

- Ⓐ Projecting different images from each projector, and creating a seamless screen

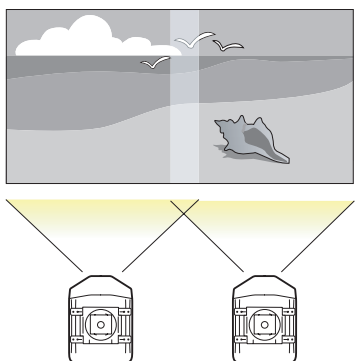

- Ⓑ Projecting the same image from each projector, using the Scale function to project a large image

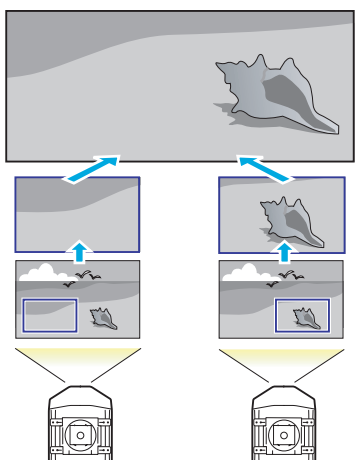

## Preparation Flow

The following is an example of using method Ⓐ. (Method Ⓑ follows the same basic flow except you use the scale function to adjust the position of the projected image [p.183](#))

1. Requirements
2. Setting the projector ID and the remote control ID
3. Adjusting the position of the projected image
4. Checking the Color Mode
5. Using the edge blending function
6. Adjusting to match colors

Settings are explained here using the remote control, but they can also be set by the control panel.

## Requirements

- Two or more projectors that support Edge Blending
- A dedicated computer with a GPU that has two or more outputs (VGA, DVI, HDMI, etc.) and supports Edge Blending
- Cables to connect the computer to the projectors

## Projector ID/Remote Control ID

When an ID is set for the projector and the remote control, you can use the remote control to operate only the projector with a matching ID. This is very useful when managing multiple projectors.

When operating all of the projectors from the remote control, set the ID switch on the side of the remote control to Off.



- Operation using the remote control is possible only for projectors that are within the operating range of the remote control. 🖱️ "Operating range of remote control" p.23
- When **Remote Control Type** is set to **Simple** from **Operation** in the configuration menu, you cannot set the remote control ID. 🖱️ p.67
- IDs are ignored when the projector ID is set to **Off** or the remote control ID is set to **0**.

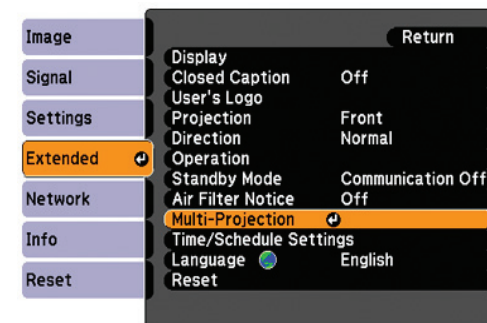

## Setting the projector ID

### Procedure

- 1 During projection, press the [Menu] button and select Extended - "Multi-Projection" from the configuration menu. 🖱️ "Using the Configuration Menu" p.55

Remote Control

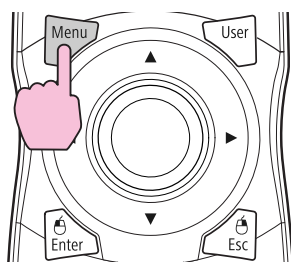

- 2 Select "Projector ID", and then press the [Enter] button.
- 3 Select one of the numbers from 1 to 9 to use as the ID and then press the [Enter] button.

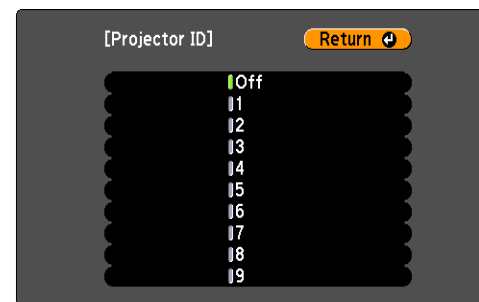

- 4 Press the [Menu] button to close the configuration menu.

## Checking the Projector ID

Use the following procedure to check the projector ID.



## Procedure

- 1 Set the remote control ID switch to On.

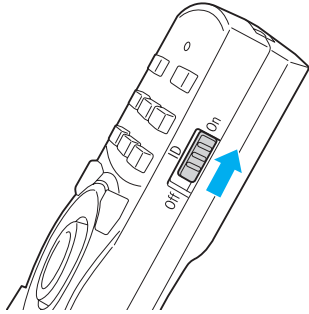

- 2 During projection, while holding the [ID] button, press the [Help] button.

### Remote Control

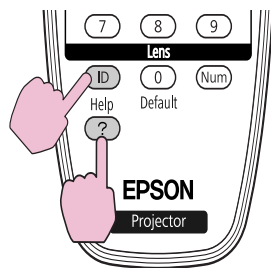

When you press the buttons, the current Projector ID is displayed on the projection screen. It disappears in about three seconds.

## Setting the remote control ID

### Procedure

- 1 Set the remote control ID switch to On.

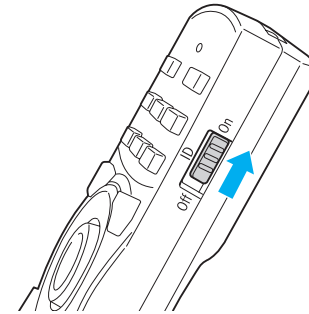

- 2 While holding the [ID] button, press a number button to select a number to match the ID of the projector you want to operate. ➔ "Checking the Projector ID" p.176

### Remote Control

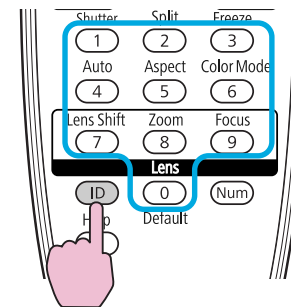

Once this setting has been made, the projector that can be operated by the remote control is limited.



The remote control ID setting is saved in the remote control. Even if the remote control batteries are removed to replace them and so on, the stored ID setting is retained. However, if the batteries are left out for a long time, it is reset to the default value (ID0).

## Adjusting the Position of the Projected Image

Adjust the position of the projected image, starting from the adjustments that have larger corrections. For the best results, use physical adjustments (moving the projector's position, optical zoom, and lens shift) as much as possible to minimize the amount of digital correction (Quick Corner, Point Correction, H/V keystone, etc.) needed to correct your images.

1. Projector's position (angle) p.152
2. Image zoom p.162
3. Lens shift/Zoom p.161
4. Geometric Correction
  - Quick Corner p.164
  - Point Correction p.178



- We recommend setting the focus, zoom, and lens shift at least 30 minutes after you start the projection, because images are not stable right after turning on the projector.
- The Test Pattern can be displayed to adjust the projection status without connecting video equipment. p.159
- When projecting from multiple projectors, correction is easier if images are displayed as is (aspect ratio and image resolution are maintained) and without being enlarged or reduced in size.]
- We recommend projecting from the center of the lens when possible. As you get to the edges, the lens gets thinner which can cause distortion and affect the quality of the blend.

## Point Correction

Corrects slight distortion which occurs partially, or adjusts the screen position in an overlapping area when projecting from multiple projectors.

A grid is placed on top of the projected image and you can move the points of intersection on the grid left, right, up, or down to correct distortion.

### Procedure



**During projection, press the [Menu] button. Select Settings menu - "Geometric Correction" and then press the [Enter] button. "Using the Configuration Menu" p.55**

Remote Control

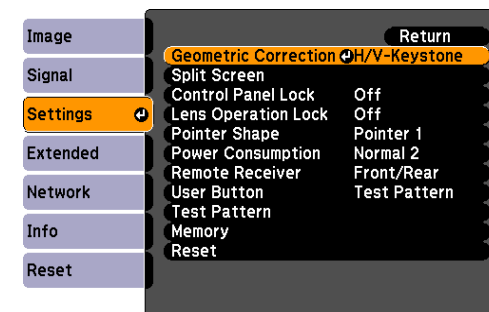
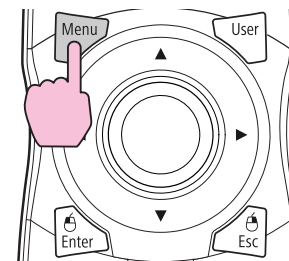

2 Select "Point Correction", and then press the [Enter] button.

3 Select "Grid Size", and then press the [Enter] button.

4 Select one of "3x3", "5x5", or "9x9", and then press the [Enter] button.

5 Press the [Esc] button to return to the previous screen.

6 Select "Start Adjustments", and then press the [Enter] button.

According to the value selected in **Grid Size**, the point selection screen is displayed on the projected image.

 You can change the color of the guide using the **Pattern Color** setting.

7 Move the [⊙] button to the point you want to correct, then press the [Enter] button.

### Remote Control

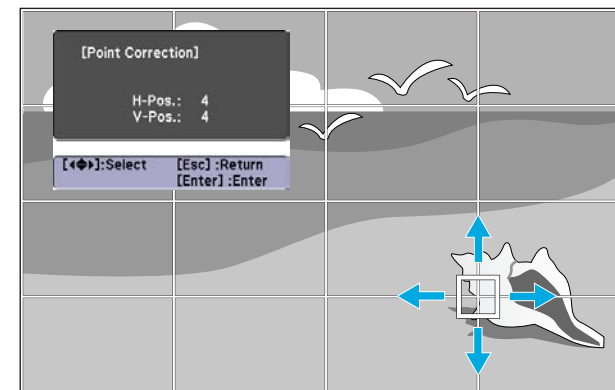
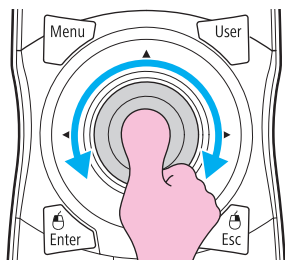

If the [Esc] button is held down for about two seconds while selecting the point, the confirm default reset screen is displayed.

Select "Yes" to reset the results of any Point Correction adjustments.

**8** Press the [⊙] button to correct the distortion.

### Remote Control

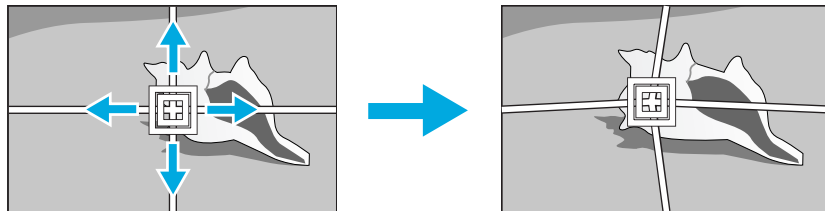
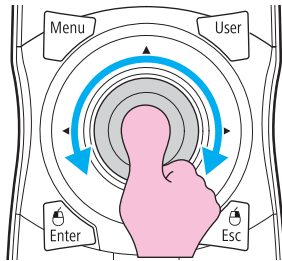

To continue to correct another point, press the [Esc] button to return to the previous screen, then repeat steps 7 and 8.



- If you press the [Default] button while adjusting a point, the value of the point that you are adjusting is reset to the default.

**9** When you are done, press the [Esc] button to exit the correction menu.

## Checking the Color Mode

Set the Color Mode to **Multi-Projection**. p.34

## Using the Edge Blending Function

When multiple projectors are lined up and projecting images, you can create a seamless screen.

Adjust the following settings on the Edge Blending menu to correct the image.

Sub Menu	Function
Edge Blending	Set to <b>On</b> to activate the edge blending function. Set to <b>Off</b> when not projecting from multiple projectors.
Top Edge/Bottom Edge/Right Edge/Left Edge	<b>Blending:</b> Enable this setting on the sides of the projected image you want to blend. A gradient appears indicating the area where blending occurs. <b>Blend Range:</b> Adjusts the width of the blending area. You can adjust the width down to increments of one pixel at a time and you can blend up to 45% of the image.
Blend Curve	You can select from three gradients.
Black Level	When projecting a dark image and the blended area is brighter than the unblended area, correct the unblended area to resolve the difference in brightness. <b>Brightness Correct.:</b> Adjust the brightness of the unblended area. <b>Color Correct. (G/R):</b> Adjust the color tone of the unblended area to look more greenish or reddish. <b>Color Correct. (B/Y):</b> Adjust the color tone of the unblended area to look more bluish or yellowish.
Guide Display	Set to <b>On</b> to display a line guide on the edge of the blending area.

Sub Menu	Function
Guide Colors	You can select from three guide colors.

## Procedure

- 1 Press the [Menu] button and select Extended menu - "Multi-Projection" from the configuration menu.  "Using the Configuration Menu" p.55

Remote Control

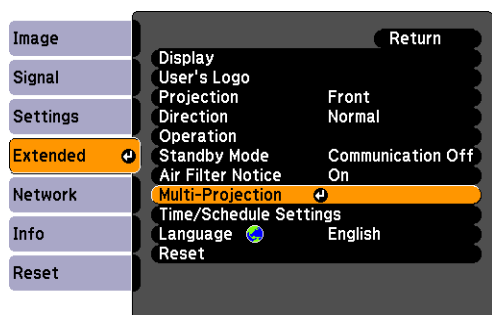
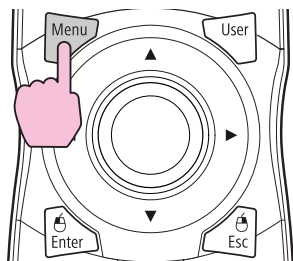

- 2 Select "Edge Blending", and then press the [Enter] button.

- 3 Turn on "Edge Blending".

- (1) Select **Edge Blending**, and then press the [Enter] button.
- (2) Select **On**, and then press the [Enter] button.
- (3) Press the [Esc] button.

- 4 Displays the guide.

- (1) Select the **Guide Display**, and then press the [Enter] button.
- (2) Select **On**, and then press the [Enter] button.
- (3) Press the [Esc] button.



If the guide is not clear, you can change the color of the guide using the **Guide Colors** setting.

- 5 Set a side for edge blending.

- (1) Select an edge (**Top Edge, Bottom Edge, Right Edge, or Left Edge**), and then press the [Enter] button.
- (2) Select **Blending**, and then press the [Enter] button.
- (3) Select **On**, and then press the [Enter] button.
- (4) Press the [Esc] button.

- (5) In **Blend Range**, adjust the width of the blended area.  
The width should be set so that the guide appears on the border of where the images overlap.

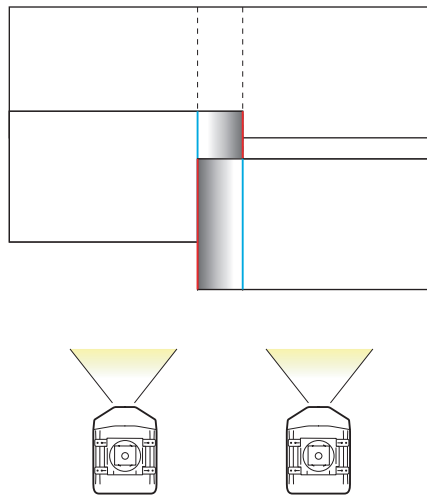

If you press the [Default] button while adjusting Blend Range, the value that you are adjusting is reset to the default.

- (6) Press the [Esc] button.



## Set "Blend Curve".

- (1) Select **Blend Curve**, and then press the [Enter] button.
- (2) Select from 3 gradient choices, and then press the [Enter] button.
- (3) Press the [Esc] button.



## Adjust the black level, if necessary.

- (1) Select **Black Level**, and then press the [Enter] button.
- (2) In **Brightness Correct.**, adjust the brightness of the unblended area.
- (3) In **Color Correct. (G/R)**, adjust the color tone of the unblended area to look more greenish or reddish.
- (4) In **Color Correct. (B/Y)**, adjust the color tone of the unblended area to look more bluish or yellowish.
- (5) Press the [Esc] button.



If you press the [Default] button while adjusting Brightness Correct., Color Correct. (G/R), or Color Correct. (B/Y), the item that you are adjusting is reset to its default.

---

## Adjusting to Match Colors on Multi-Projection

When multiple projectors are lined up and projecting images, you can manually correct the brightness and color tone of each projector's image so that the colors projected from each projector match closely.

In some cases the brightness and color tone may not match completely even after correction.

Make the following settings on the Multi-Projection menu to correct the image.

Sub Menu	Function
Brightness Level	Adjust when the brightness of each projector is different.
Multi-screen	<p><b>Adjustment Level:</b> Change the adjustment level of the projected image.</p> <p><b>Brightness Correct.:</b> Adjust the brightness.</p> <p><b>Color Correct. (G/R):</b> Adjust the color tone to look more greenish or reddish.</p> <p><b>Color Correct. (B/Y):</b> Adjust the color tone to look more bluish or yellowish.</p>



If the overlapping part of dark images is brighter than the rest of the image, adjust the Black Level again.

## Displays the Image Partly Enlarged (Scale)

### Procedure



During projection, press the [Menu] button. Select Signal menu - "Scale" and then press the [Enter] button. ["Using the Configuration Menu" p.55](#)

Remote Control

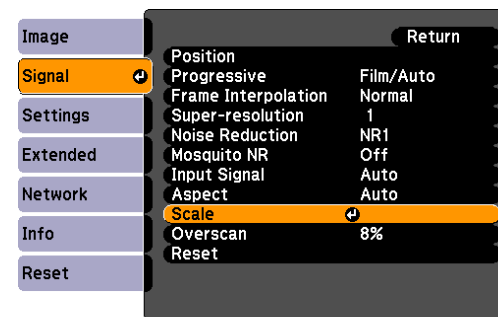
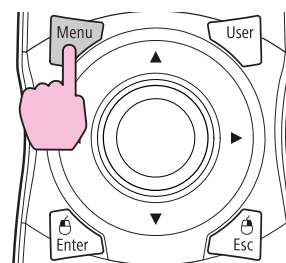

Select "Scale", and then select "On".

**3** Select "Scale Mode", and then select the scale.

<b>Full Display</b>	When the image is not resized, it is projected the same as projected by Normal aspect mode.
<b>Zoom Display</b>	The image is displayed at the range that is selected on the aspect mode.  <a href="#">p.27</a>

**4** Select one of the scaling options, and then adjust the scale.

Adjusting the row with the "-" and "+" sign allows you to scale both horizontally and vertically at the same time. You can also scale in one direction by selecting "Scale Vertically" or "Scale Horizontally".

**5** Set "Image Display Range".

Adjust this setting while watching the screen. The clipping values displayed on-screen and the size of the clipped area may vary depending on the screens to be matched, such as when matching top and bottom screens or left and right screens.



## Setting Schedule

You can schedule turning the projector power on/off and switching the input source, as events in the schedule. Registered events are executed automatically at the specified time on the specified dates or weekly.

## Setting Methods

You can make settings from the computer by using the Web Remote function.  [p.129](#)

### Procedure

- 1 **Press the [Menu] button, and select Extended - "Time/Schedule Settings" from the configuration menu.**  
 **"Using the Configuration Menu" [p.55](#)**

Using the Remote Control

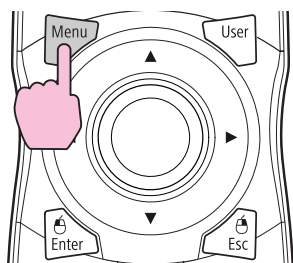

Using the Control Panel

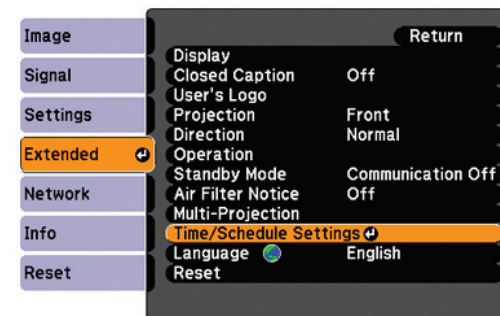
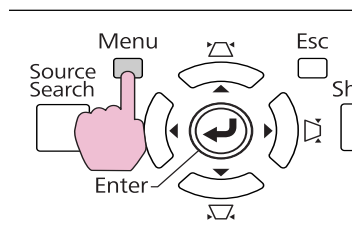

- 2 **Set the time and schedule.**

Selecting from the top menu and sub menus, and changing of selected items are the same as operations in the configuration menu.

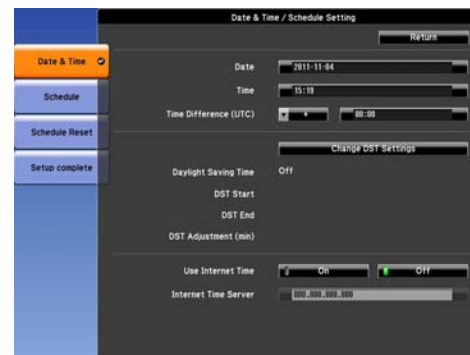

To delete all registered schedules, select **Schedule Reset**, then select **Yes**.

- 3 **Select the Setup Complete menu, and then select "Yes".**  
 You can return to the configuration menu.

## Clock

Sub Menu	Function
<b>Date</b>	Set today's date in the projector.
<b>Time</b>	Set the current time in the projector.
<b>Time Difference (UTC)</b>	Set the time difference from Coordinated Universal Time.
<b>Change DST Settings</b>	Displays the screen to set the daylight saving time.
<b>Use Internet Time</b>	Set to <b>On</b> to update the time automatically through an Internet time server.
<b>Internet Time Server</b>	Input the IP address for an Internet time server.

## Daylight Saving Time screen

Sub Menu	Function
<b>Daylight Saving Time</b>	Set whether or not ( <b>On/Off</b> ) to activate the daylight saving time.
<b>DST Start</b>	Set the date and time to start the daylight saving time.
<b>DST End</b>	Set the date and time to end the daylight saving time.
<b>DST Adjustment (min)</b>	Adjusts the time difference between the standard time and the daylight saving time.

## Schedule

You can display the list of registered schedules.  
 When you select **Edit** on a registered schedule or **New Event**, the Clock / Schedule Setting screen is displayed.

You can register up to 30 events.

## Clock / Schedule Setting screen

Sub Menu	Function
<b>Event Settings</b>	Select an operation of the projector when the event is executed.
<b>Date / Time Settings</b>	Set the date and time to execute the event.

## Connecting to External Equipment

### Connecting a LAN Cable

Connect with a commercially available 100BASE-TX or 10BASE-T LAN cable.

Connected equipment	Connecting cable	Projector port
LAN port on network hub	LAN cable (commercially available)	LAN port 

### Caution

To prevent malfunctions, use a category 5 shielded LAN cable.

### Connecting to an External Monitor

You can display computer on an external monitor connected to the projector and the projection screen at the same time. You can check projected images on an external monitor when giving presentations even if you cannot see the screen. Connect using the cable supplied with the external monitor.

Connected equipment	Connecting cable	Projector port
Monitor	Cable supplied with monitor	Monitor Out port 



- Only analog RGB signals from a computer connected to the Computer input port or the BNC input port can be displayed on an external monitor. Images from equipment connected to other ports and component video signals cannot be displayed.
- The image cannot be displayed on an external monitor when the projector is on standby.
- Setting gauges such as Keystone, the configuration menu, or Help screens are not output to the external monitor.

## Installing Optional and Supplied Accessories

Prepare #2 plus-driver in advance.

## Removing and Attaching the Projector Lens Unit

### Removing

#### Caution

- Only remove the lens unit when necessary. If dust or dirt enter the projector, projection quality deteriorates and it could cause a malfunction.
- Try not to touch the lens with your hand or fingers. If fingerprints or oils are left on the surface of the lens, projection quality deteriorates.
- Before replacing the lens unit, use the lens shift function to horizontally and vertically center the lens. 🖱️ [p.161](#)

## Procedure

- 1 Remove the interface cover.

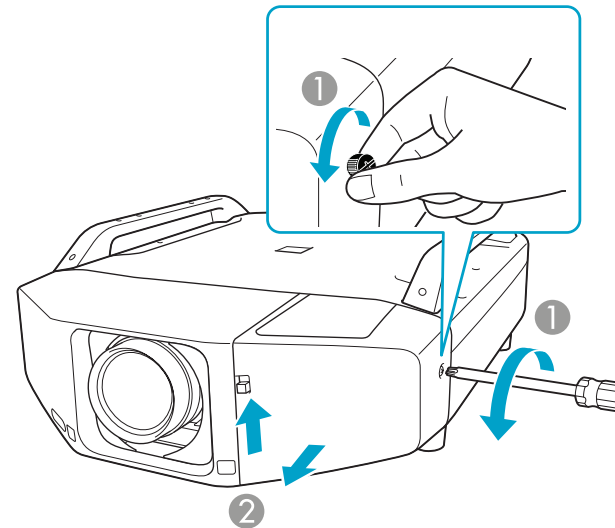

- 1 Loosen the screw. (Thumb screw available on PowerLite Pro Z8255NL/Z8455WUNL only.)
- 2 While pulling up the interface cover open switch, pull the interface cover straight out.

## 2 Remove the front cover.

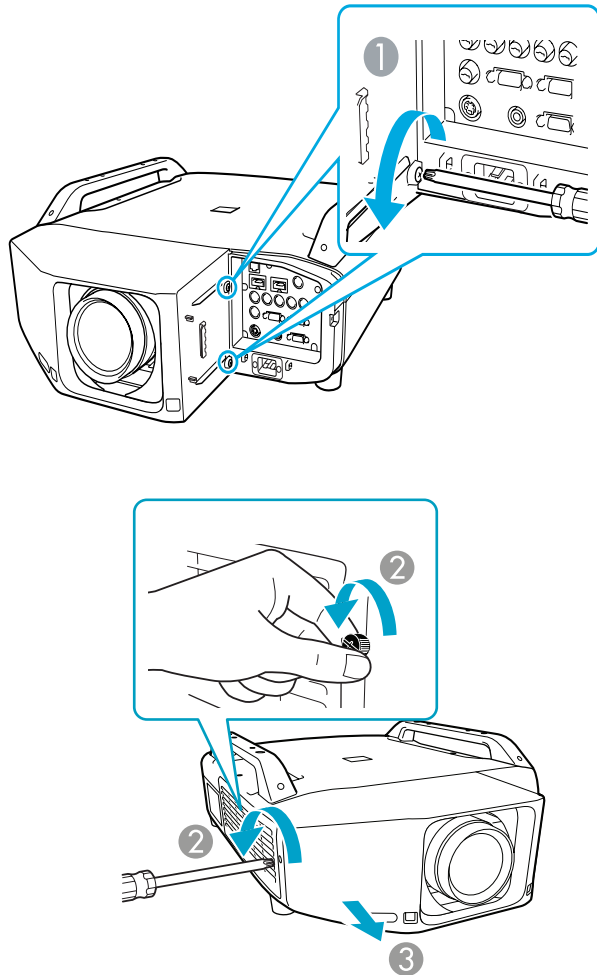

- 1 Loosen the two screws.
- 2 Loosen the screw. (Thumb screw available on PowerLite Pro Z8255NL/Z8455WUNL only.)
- 3 Pull the cover straight out.

## 3 Pinch the lock lever of the lens unit and turn it counterclockwise.

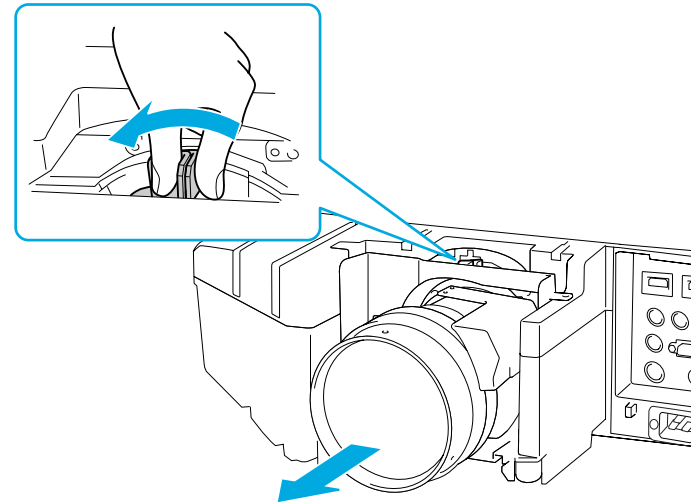

## 4 Once it is released, pull the lens unit straight out.

### Attaching

#### Caution

*Do not remove or attach the lens unit when the projector's lens area is facing up. Dust or dirt could enter the projector.*

## Procedure

- 1 Insert the lens unit straight into the lens insertion section with the white circle on the lens on top.

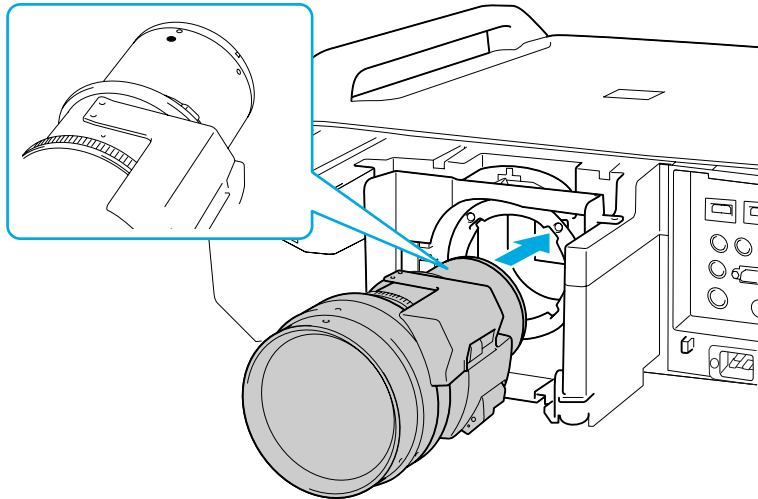

- 2 While holding the lens unit firmly, turn the lock lever clockwise until it is locked. Check that the lens cannot be detached.

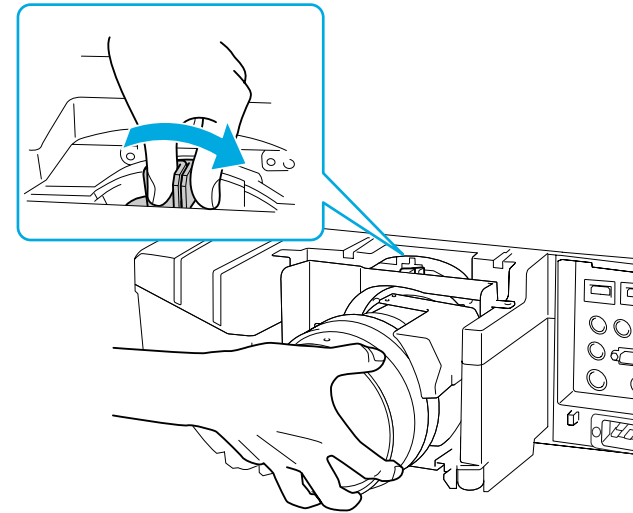

**3** Replace the front cover.

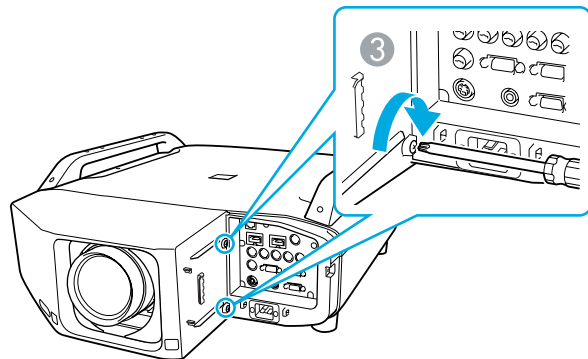
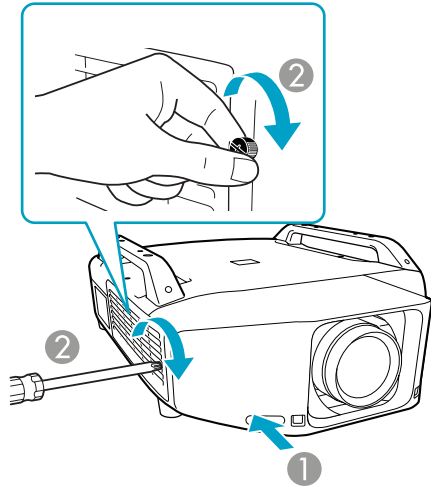

- 1 Install the cover along the guide.
- 2 Tighten the screw. (Thumb screw available on the PowerLite Pro Z8255NL/Z8455WUNL only.)

**3** Tighten the two screws.

**4** Replace the interface cover.

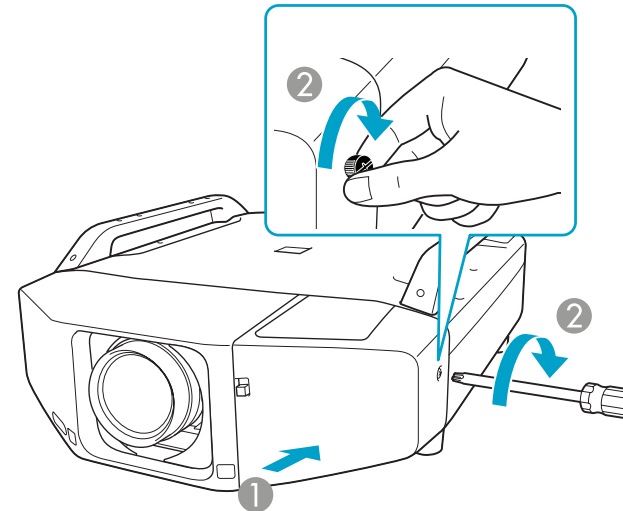

- 1 Install the cover along the guide.
- 2 Tighten the screw.

**Caution**

- Install the front cover before using the projector.
- Store the projector with the lens unit installed.  
If the projector is stored without the lens unit, dust and dirt may get inside the projector and cause malfunctions or lower the quality of projection.

## Installing the Wireless LAN Unit (V12H418P12)

### Attaching

#### Procedure

- 1 Remove the interface cover.

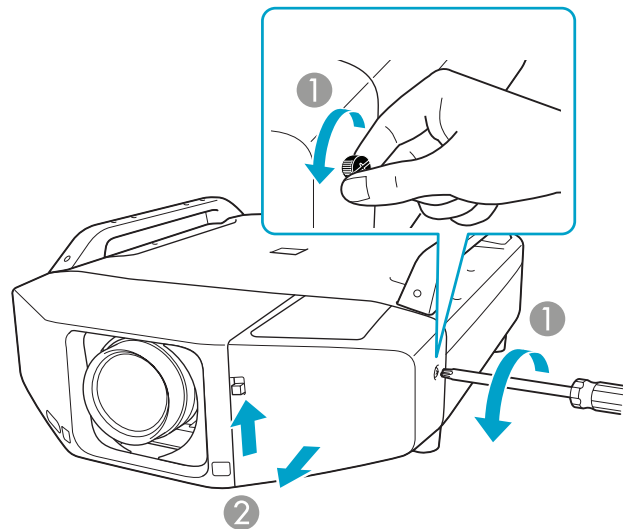

- 1 Loosen the screw. (Thumb screw available on the PowerLite Pro Z8255NL/Z8455WUNL only.)
- 2 While pulling up the interface cover open switch, pull the interface cover straight out.

- 2 Install the Wireless LAN unit.

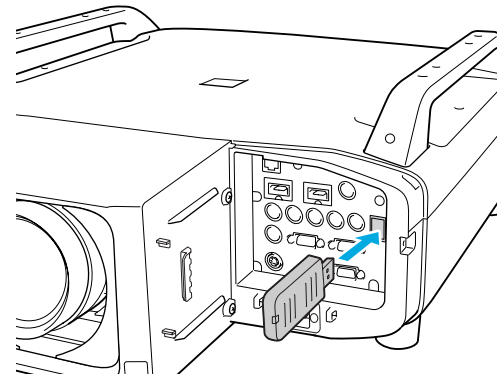

After connecting the wireless LAN module to the projector, set the **Wireless LAN Power** setting on the **Wireless LAN** menu to **On**. (The default setting is **On**.) [p.74](#)





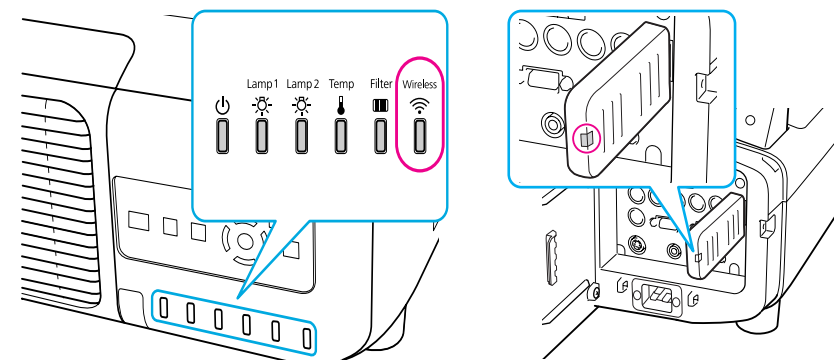

### Reading the wireless LAN indicators

There are two wireless LAN indicators, one on the projector and one on the Wireless LAN unit.





 : Flashing  
  : Lit  
  : Off

Status	Indicator on projector	Indicator on Wireless LAN unit
The Wireless LAN unit not connected or the <b>Wireless LAN Power</b> setting on the <b>Wireless LAN</b> menu is <b>Off</b>		
The Wireless LAN unit connected to the projector but not connected to the network		
The Wireless LAN unit connected to the projector and connected to the network		
The Wireless LAN unit connected to the projector, connected to the network, and communicating		

## Attaching and Removing the Interface Cover

### Removing

#### Procedure

-  **Loosen the screw. (Thumb screw available on the PowerLite Pro Z8255NL/Z8455WUNL only.)**

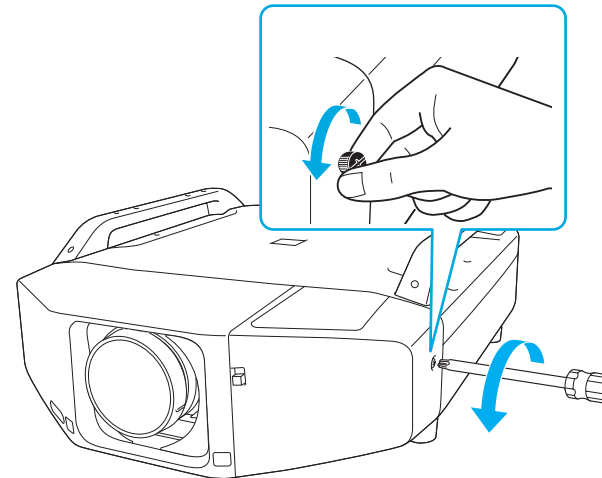

- 2 While pulling up the interface cover open switch, pull the interface cover straight out.

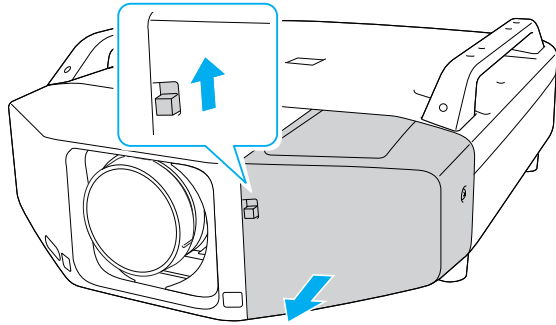

- 2 Install the cover along the guide.

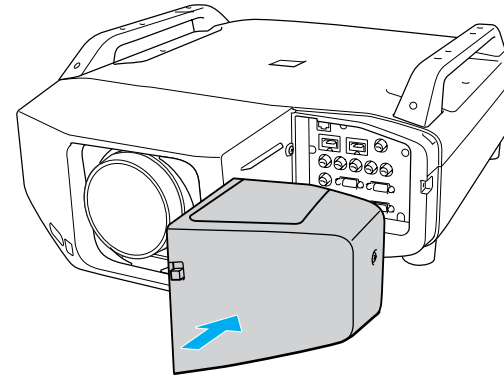

## Attaching

### Procedure

- 1 Remove the top cover when ejecting the connected cables upward. Remove the bottom cover when ejecting the connected cables downward.

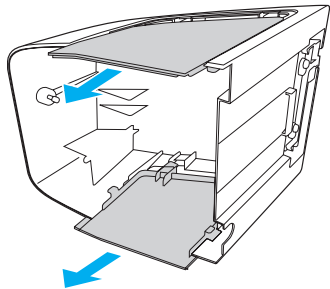

- 3 Tighten the screw. (Thumb screw available on the PowerLite Pro Z8255NL/Z8455WUNL only.)

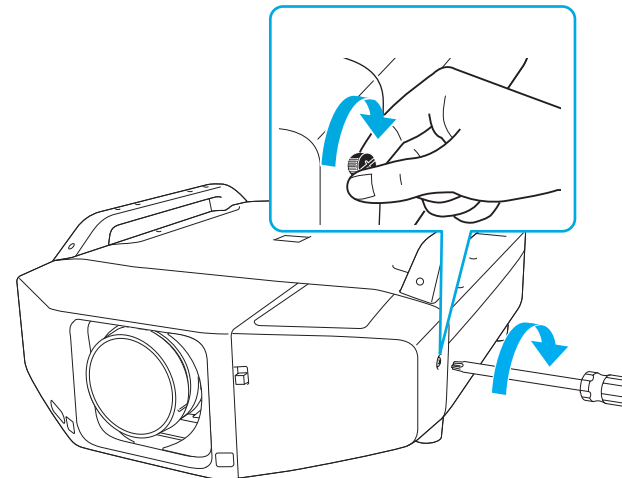

## Removing the Feet

When mounting the projector on the ceiling, you can remove the feet and attach the supplied foot covers for clean appearance.

### Procedure

- 1 Remove the feet.**

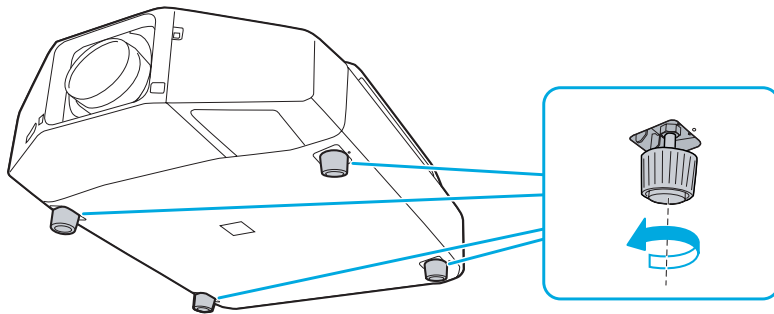

- 2 Attach the supplied foot covers.**

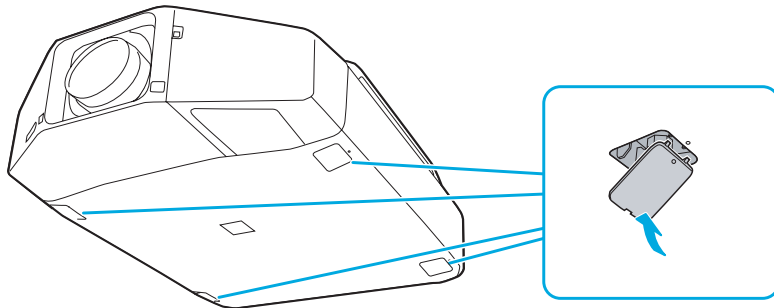

# Appendix

Optional Accessories and Consumables

## Optional Accessories

The following optional accessories and consumables are available.

Product	Part Number
<b>Standard zoom lens (ELPLS04)</b>	V12H004S04
<b>Long throw zoom lens (ELPLL07)</b>	V12H004L07
<b>Middle throw zoom lens 1 (ELPLM06)</b>	V12H004M06
<b>Middle throw zoom lens 2 (ELPLM07)</b>	V12H004M07
<b>Rear projection wide lens (ELPLR04)</b>	V12H004R04
<b>Wide zoom lens (ELPLW04)</b>	V12H004W04
<b>Flush Ceiling Mount Bracket</b>	V12H003B25
<b>Mount Bracket with Extended Pipe</b>	V12H003B26
<b>Kensington security lock</b>	ELPSL01
<b>Remote control cable set</b>	V12H005C28
<b>Replacement remote control</b>	1558838
<b>Wireless IR mouse receiver for remote control</b>	V12H007T16
<b>Wireless LAN module</b>	V12H418P12

## Consumables

Product	Part Number
<b>Air filter</b>	V13H134A23
<b>Replacement lamp unit one-pack (ELPLP72)</b>	V13H010L72

Product	Part Number
<b>Replacement lamp unit two-pack (ELPLP73)</b>	V13H010L73

## Screen Size and Projection Distance

Use the tables below to help you determine placement. Image size increases with distance, but can vary depending on which lens you're using and whether you've adjusted the image with zoom or any other settings. For more precise measurements, you can also use the Projection Distance Calculator on the Epson website.

### PowerLite Pro Z8150NL/Z8250NL/Z8255NL (4:3 image)

Lens	Screen or image size	Throw Ratio	Zoom Ratio	Focal Length	F-number
Standard zoom lens (ELPLS04)	60 to 500 inches	1.63 - 2.65	1 - 1.61	36.00 to 57.35 mm	1.65 - 2.51
Wide zoom lens (ELPLW04)	60 to 500 inches	1.23 - 1.68	1 - 1.37	27.32 - 37.04 mm	1.8 - 2.26
Rear projection wide lens (ELPLR04)	60 to 500 inches	0.72	–	16.15 mm	1.85
Middle throw zoom lens (ELPLM06)	60 to 500 inches	2.51 - 3.85	1 - 1.5	55.43 to 83.3 mm	1.81 - 2.4
Middle throw zoom lens (ELPLM07)	60 to 500 inches	3.66 - 5.60	1 - 1.5	80.59 to 121.1 mm	1.81 - 2.34
Long throw zoom lens (ELPLL07)	60 to 500 inches	5.45 - 7.67	1 - 1.39	118.98 to 165.39 mm	1.8 - 2.45

### PowerLite Pro Z8350WNL (16:10 image)

Lens	Screen or image size	Throw Ratio	Zoom Ratio	Focal Length	F-number
Standard zoom lens (ELPLS04)	60 to 500 inches	1.71 - 2.78	1 - 1.61	36.00 to 57.35 mm	1.65 - 2.51
Wide zoom lens (ELPLW04)	60 to 500 inches	1.29 - 1.77	1 - 1.37	27.32 - 37.04 mm	1.8 - 2.26
Rear projection wide lens (ELPLR04)	60 to 500 inches	0.76	–	16.15 mm	1.85
Middle throw zoom lens (ELPLM06)	60 to 500 inches	2.64 - 4.03	1 - 1.5	55.43 to 83.3 mm	1.81 - 2.4

Lens	Screen or image size	Throw Ratio	Zoom Ratio	Focal Length	F-number
Middle throw zoom lens (ELPLM07)	60 to 500 inches	3.85 - 5.88	1 - 1.5	80.59 to 121.1 mm	1.81 - 2.34
Long throw zoom lens (ELPLL07)	60 to 500 inches	5.76 - 8.09	1 - 1.39	118.98 to 165.39 mm	1.8 - 2.45

### PowerLite Pro Z8450WUNL/Z8455WUNL (16:10 image)

Lens	Screen or image size	Throw Ratio	Zoom Ratio	Focal Length	F-number
Standard zoom lens (ELPLS04)	60 to 500 inches	1.74 - 2.82	1 - 1.61	36.00 to 57.35 mm	1.65 - 2.51
Wide zoom lens (ELPLW04)	60 to 500 inches	1.31 - 1.80	1 - 1.37	27.32 - 37.04 mm	1.8 - 2.26
Rear projection wide lens (ELPLR04)	60 to 500 inches	0.77	–	16.15 mm	1.85
Middle throw zoom lens (ELPLM06)	60 to 500 inches	2.68 - 4.10	1 - 1.5	55.43 to 83.3 mm	1.81 - 2.4
Middle throw zoom lens (ELPLM07)	60 to 500 inches	3.92 - 5.97	1 - 1.5	80.59 to 121.1 mm	1.81 - 2.34
Long throw zoom lens (ELPLL07)	60 to 500 inches	5.83 - 8.18	1 - 1.39	118.98 to 165.39 mm	1.8 - 2.45

## Supported Monitor Displays

## Supported Monitor Displays

## Computer signals (analog RGB)

Signal	Refresh Rate (Hz)	Resolution (dots)
VGA	60/72/75/85	640x480
SVGA	56/60/72/75/85	800x600
XGA	60/70/75/85	1024x768
WXGA	60	1280x768
	60	1366x768
	60/75/85	1280x800
WXGA+	60/75/85	1440x900
WSXGA+ <sup>*1</sup>	60	1680x1050
WXGA++	60	1600x900
SXGA	70/75/85	1152x864
	60/75/85	1280x1024
	60/75/85	1280x960
SXGA+	60/75	1400x1050
UXGA	60	1600x1200
WUXGA <sup>*2</sup>	60	1920x1200

\*1 PowerLite Pro Z8350WNL/Z8450WUNL/Z8455WUNL only. Only compatible when Wide is selected as the Resolution from the configuration menu.

\*2 PowerLite Pro Z8450WUNL/Z8455WUNL only. Only compatible when

VESA CVT-RB (Reduced Blanking) signal is input.

Even when signals other than those mentioned above are input, it is likely that the image can be projected. However, not all functions may be supported.

## Component Video

Signal	Refresh Rate (Hz)	Resolution (dots)
SDTV(480i)	60	720x480
SDTV(576i)	50	720x576
SDTV(480p)	60	720x480
SDTV(576p)	50	720x576
HDTV(720p)	50/60	1280x720
HDTV(1080i)	50/60	1920x1080
HDTV(1080p) <sup>*</sup>	50/60	1920x1080

\* PowerLite Pro Z8450WUNL/Z8455WUNL only

## Composite Video/S-Video

Signal	Refresh Rate (Hz)	Resolution (dots)
TV(NTSC)	60	720x480
TV(PAL,SECAM)	50/60	720x576



## Input signals from HDMI1/2 input port

Signal	Refresh Rate (Hz)	Resolution (dots)
VGA	60	640x480
SVGA	60	800x600
XGA	60	1024x768
WXGA	60	1280x800
SXGA	60	1280x960
	60	1280x1024
SXGA+	60	1400x1050
WXGA++	60	1600x900
WXGA	60	1366x768
WXGA+	60	1440x900
UXGA	60	1600x1200
WSXGA+ <sup>*1</sup>	60	1680x1050
WUXGA <sup>*2</sup>	60	1920x1200
SDTV(480i)	60	720x480
SDTV(480p)	60	720x480
SDTV(576i)	50	720x576
SDTV(576p)	50	720x576
HDTV(720p)	50/60	1280x720
HDTV(1080i)	50/60	1920x1080
HDTV(1080p)	24/30/50/60	1920x1080

\*1 PowerLite Pro Z8350WNL/Z8450WUNL/Z8455WUNL only.

\*2 PowerLite Pro Z8450WUNL/Z8455WUNL only. Only compatible when VESA CVT-RB (Reduced Blanking) signal is input.

Input signals from SDI input port  
(PowerLite Pro Z8450WUNL/Z8455WUNL only)

Signal	Refresh Rate (Hz)	Resolution (dots)
SDTV(480i)	60	720x480
SDTV(576i)	50	720x576
HDTV(720p)	50/60	1280x720
HDTV(1080i)	50/60	1920x1080
HDTV(1080p)	24/25/30	1920x1080

## Supported Certificates

**Client Certificate (PEAP-TLS/EAP-TLS)**

Item	Explanation
Supported format	PKCS#12
Extension	PKCS, P12
Encryption	RSA
Hashes	MD5/SHA-1/SHA-256/SHA-384/SHA-512
Key length	512/1024/2048/4096 bit
Password	Required (up to 32 alphanumeric characters)

**Server Certificate (PEAP/PEAP-TLS/EAP-TLS/EAP-Fast)**

Item	Explanation
Supported format	X509v3
Extension	DER/CER/PEM
Encryption	RSA
Hashes	MD5/SHA-1/SHA-256/SHA-384/SHA-512
Key length	512/1024/2048/4096 bit
Encode	BASE64/Binary

**Web Server Certificate (Secure HTTP)**

Item	Explanation
Supported format	PKCS#12
Extension	PKCS, P12

Item	Explanation
Encryption	RSA
Hashes	MD5/SHA-1/SHA-256/SHA-384/SHA-512
Key length	512/1024/2048/4096 bit
Common Name	Network host name
Organization	Optional
Password	Required (up to 32 alphanumeric characters)

Specifications

## Projector General Specifications

Product name	PowerLite Pro Z8450WUNL/ Z8455WUNL	PowerLite Pro Z8350WNL	PowerLite Pro Z8250NL/Z8255NL	PowerLite Pro Z8150NL
<b>Dimensions</b>	21.0 inches (534 mm) (W) × 6.6 inches (167 mm) (H) × 28.9 inches (734 mm) (D) (not including feet, projection lens, and handle)			
<b>Panel size</b>	0.94" Wide	0.95" Wide	1.06"	
<b>Display method</b>	Polysilicon TFT active matrix			
<b>Resolution</b>	2,304,000 pixels WUXGA (1920 (W) × 1200 (H) dots) × 3	1,024,000 pixels WXGA (1280 (W) × 800 (H) dots) × 3	786,432 pixels XGA (1024 (W) × 768 (H) dots) × 3	
<b>Light output (brightness)</b>	Normal mode: White light output 7000 lumens (ISO 21118 standard), Color light output 7000 lumens  ECO mode: Light output 5300 lumens	Normal mode: White light output 8500 lumens (ISO 21118 standard), Color light output 8500 lumens  ECO mode: Light output 6500 lumens	Normal mode: White light output 10000 lumens (ISO 21118 standard), Color light output 10000 lumens  ECO mode: Light output 7600 lumens	White light output 8000 lumens (ISO 21118 standard), Color light output 8000 lumens
<b>Focus adjustment</b>	Automatic			
<b>Zoom adjustment<sup>*1</sup></b>	Automatic (1-1.6)			
<b>Lens shift<sup>*1</sup></b>	Automatic (Vertical direction: Maximum approx. 70%, Horizontal direction: Maximum approx. 20%)		Automatic (Vertical direction: Maximum approx. 56%, Horizontal direction: Maximum approx. 6%)	
<b>Lamp</b>	UHE lamp, 340 W Two-lamps			
<b>Lamp life<sup>*2</sup></b>	Up to about 2500 hours (Normal mode), Up to about 3500 hours (ECO mode)			Up to about 2500 hours
<b>Noise level</b>	40 dB (Normal mode), 35 dB (ECO mode)			37 dB
<b>Power supply</b>	100-240V AC ±10%, 50/60 Hz 9.8 to 4.3A			100-240V AC ±10%, 50/60 Hz 8.3 to 3.5A

<b>Power consumption</b>	<b>100 to 120 V area</b>	Operating: 968 W (Normal mode), 773 W (ECO mode) Standby: 4.3 W (Communication On), 0.4 W (Communication Off)	Operating: 822 W Standby: 4.3 W (Communication On), 0.4 W (Communication Off)
	<b>220 to 240 V area</b>	Operating: 911 W (Normal mode), 738 W (ECO mode) Standby: 5.1 W (Communication On), 0.5 W (Communication Off)	Operating: 786 W Standby: 5.1 W (Communication On), 0.5 W (Communication Off)
<b>Operating altitude</b>		0 to 10000 ft (0 to 3048 m) (Set High Altitude Mode to <b>On</b> when using the projector above 4921 ft (1500 m).)	
<b>Operating temperature</b> <sup>*3</sup>		32 to 122 <sup>*</sup> F (0 to 50°C (No condensation)	
<b>Storage temperature</b>		14 to 140 <sup>*</sup> F (-10 to 60°C) (No condensation)	
<b>Weight</b> <sup>*1</sup>		Approx. 48.4 lb (22 kg) (including lens)	
<b>Safety and Approvals</b>		United States: FCC 47CFR Part 15B Class B (DoC), UL60950-1 2nd edition (cTUVus Mark) Canada: ICES-003 Class B, CSA C22.2 No. 60950-1 CE Marking: EMC Directive (2004/108/EC), IEC 60950-1 2nd edition (CE Marking)	

- \*1 The specifications are when a standard lens is attached. When an optional lens is attached, check the User's Guide supplied with the optional lenses.
- \*2 Turn off this product when not in use to prolong the life of the projector. Lamp life will vary depending upon mode selected, environmental conditions, and usage. Brightness decreases over time.
- \*3 The operating temperature is 32 to 122°F (0 to 50°C) when Power Consumption is set to Normal 2, and 32 to 113°F (0 to 45°C) when it is set to Normal 1 at an altitude of 0 to 4921 ft (0 to 1500m).  
The operating temperature is 32 to 113°F (0 to 45°C) when Power Consumption is set to Normal 2, and 32 to 104°F (0 to 40°C) when it is set to Normal 1 at an altitude of 4921 to 10000 ft (1500 to 3048m).

Product name			PowerLite Pro Z8450WUNL/ Z8455WUNL	PowerLite Pro Z8350WNL	PowerLite Pro Z8250NL/Z8255NL	PowerLite Pro Z8150NL
<b>Connectors</b>	<b>Computer Input Port</b>	<b>1</b>	Mini D-Sub15-pin (female) blue			
	<b>BNC input port</b>	<b>1</b>	5BNC (female)			
	<b>Video input port</b>	<b>1</b>	1BNC (female)			
	<b>S-Video input port</b>	<b>1</b>	Mini DIN 4-pin			
	<b>HDMI1 input port</b>	<b>1</b>	HDMI HDCP compatible			
	<b>HDMI2 input port</b>	<b>1</b>	HDMI HDCP compatible			
	<b>SDI input port</b>	<b>1</b>	1BNC (female)	-		
	<b>Monitor Out port</b>	<b>1</b>	Mini D-Sub15-pin (female) black			
	<b>USB port (Only for Wireless LAN unit)*</b>	<b>1</b>	USB connector (Type A)			
	<b>LAN port</b>	<b>1</b>	RJ-45			
	<b>RS-232C port</b>	<b>1</b>	Mini D-Sub 9-pin (male)			
	<b>Remote port</b>	<b>1</b>	Stereo mini jack			

- \* USB 2.0 is supported. However, the operation of all USB compatible devices is not guaranteed.

## Angle of tilt

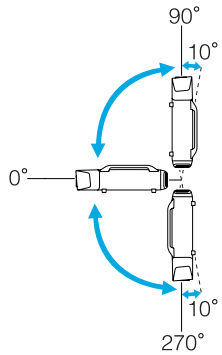

Using the projector at angles not shown in the illustrations above may damage it or cause an accident.

## Appearance

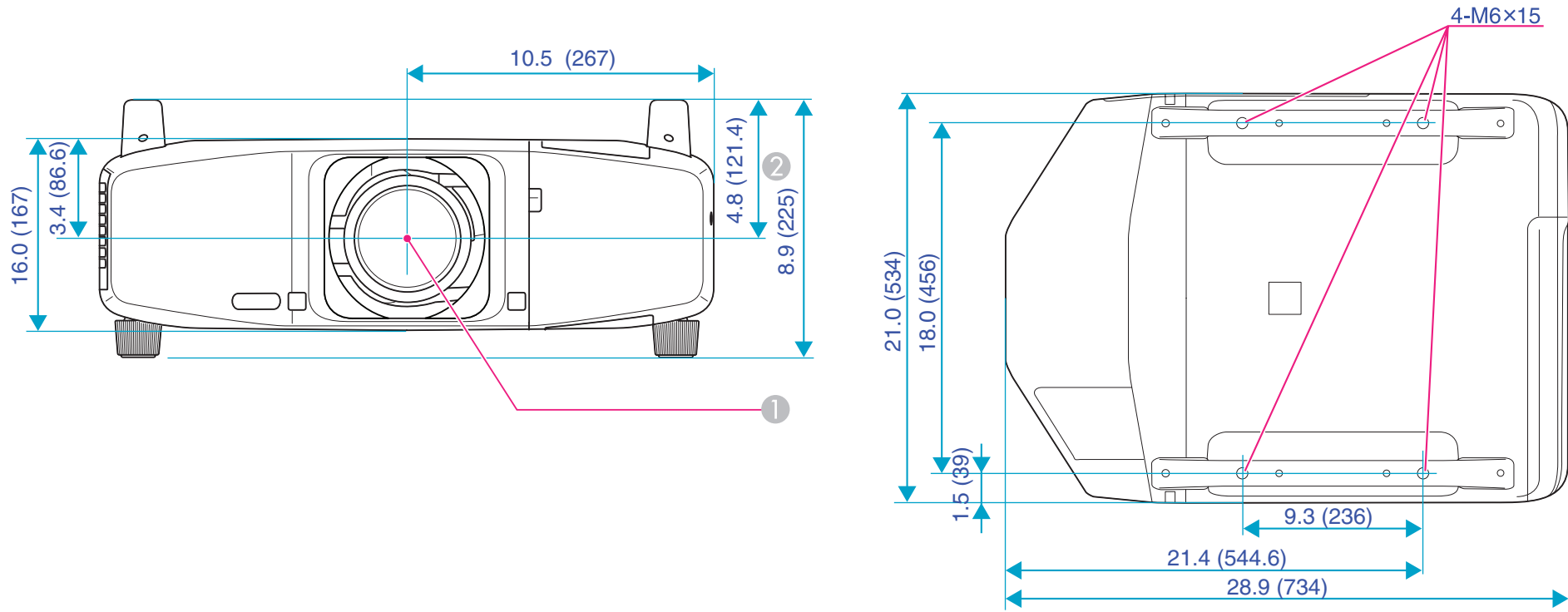

Units: inches (mm)



- ① Center of lens
- ② Distance from center of lens to suspension bracket point

## Glossary

This section explains easily terms that are used with the projector and difficult terms that are not explained in the text of this guide. For details, refer to other commercially available publications.

<b>AMX Device Discovery</b>	AMX Device Discovery is a technology developed by AMX to facilitate AMX control systems for easy operation of the target equipment. Epson has implemented this protocol technology, and has provided a setting to enable the protocol function (ON). See the AMX Web site ( <a href="http://www.amx.com/">http://www.amx.com/</a> ) for more details.
<b>DHCP</b>	An abbreviation of Dynamic Host Configuration Protocol, this protocol automatically assigns an <a href="#">IP Address</a> to equipment connected to a Network.
<b>DICOM</b>	An acronym for Digital Imaging and Communications in Medicine. An international standard that defines image standards and a communications protocol for medical images.
<b>HDCP</b>	HDCP is an abbreviation for High-bandwidth Digital Content Protection. It is used to prevent illegal copying and protect copyrights by encrypting digital signals sent over DVI and HDMI input ports. Digital images protected by HDCP technology can be projected with this projector because the projector's HDMI input ports are compatible with HDCP. However, the projector may not be able to project images protected with updated or revised versions of HDCP encryption.
<b>HDTV</b>	An abbreviation for High-Definition Television that refers to high-definition systems which satisfy the following conditions. <ul style="list-style-type: none"> <li>• Vertical resolution of 720p or 1080i or greater (p = <a href="#">Progressive</a>, i = <a href="#">Interlace</a>)</li> <li>• Screen <a href="#">Aspect Ratio</a> of 16:9</li> </ul>
<b>IP Address</b>	A number to identify a computer connected to a Network.
<b>S-Video</b>	A Video signal which has the luminance component and color component separated to provide better image quality. Refers to images that consist of two independent signals: Y (luminance signal) and C (color signal).
<b>SDI</b>	An abbreviation for Serial Digital Interface. The projector is compatible with both SD-SDI (Standard Definition) and HD-SDI (High Definition) methods.
<b>SDTV</b>	An abbreviation for Standard Definition Television that refers to standard television systems which do not satisfy the conditions for <a href="#">HDTV</a> High-Definition Television.
<b>SNMP</b>	An abbreviation for Simple Network Management Protocol, which is the protocol for monitoring and controlling devices such as routers and computers connected to a TCP/IP Network.
<b>sRGB</b>	An international standard for color intervals that was formulated so that colors that are reproduced by video equipment can be handled easily by computer operating systems (OS) and the Internet. If the connected source has an sRGB mode, set both the projector and the connected signal source to sRGB.



<b>SVGA</b>	A type of video signal with a resolution of 800 (horizontal) × 600 (vertical) dots that is used by IBM PC/AT-compatible computers.
<b>SXGA</b>	A type of video signal with a resolution of 1,280 (horizontal) × 1,024 (vertical) dots that is used by IBM PC/AT-compatible computers.
<b>VGA</b>	A type of video signal with a resolution of 640 (horizontal) × 480 (vertical) dots that is used by IBM PC/AT-compatible computers.
<b>WPS (Wi-Fi Protected Setup)</b>	Wi-Fi Protected Setup has been devised by the Wi-Fi Alliance as a means of easily setting up and securing a wireless LAN.
<b>XGA</b>	A type of video signal with a resolution of 1,024 (horizontal) × 768 (vertical) dots that is used by IBM PC/AT-compatible computers.
<b>Aspect Ratio (Aspect Ratio)</b>	The ratio between an image's length and its height. HDTV images have an aspect ratio of 16:9 and appear elongated. The aspect ratio for standard images is 4:3.
<b>Ad hoc mode</b>	A method of wireless LAN connection that communicates with wireless LAN clients without using an access point.
<b>Interlace</b>	A method of image scanning whereby the image data is divided into fine horizontal lines that are displayed in sequence starting from left to right and then from top to bottom. The even-numbered lines and odd-numbered lines are displayed alternately.
<b>Infrastructure mode</b>	A method for wireless LAN connection in which devices communicate through access points.
<b>Gateway address (Gateway Address)</b>	This is a server (router) for communicating across a network (subnet) divided according to <a href="#">subnet masks</a>  .
<b>Contrast</b>	The relative brightness of the light and dark areas of an image can be increased or decreased to make text and graphics stand out more clearly, or to make them appear softer. Adjusting this particular property of an image is called Contrast adjustment.
<b>Component Video</b>	A Video signal which has the luminance component and color component separated to provide better image quality. Refers to images that consist of three independent signals: Y (luminance signal), Pb and Pr (color difference signals).
<b>Composite video</b>	Video signals that have the video brightness signals and color signals mixed together. The type of signals commonly used by household video equipment (NTSC, PAL, and SECAM formats). The carrier signal Y (luminance signal) and chroma (color) signal that are contained in the color bar are overlapped to form a single signal.
<b>Subnet mask (Subnet Mask)</b>	This is a numerical value that defines the number of bits used for the network address on a divided network (subnet) from the <a href="#">IP Address</a>  .
<b>Sync.</b>	The signals output from computers have a specific frequency. If the projector frequency does not match this frequency, the resulting images are not of a good quality. The process of matching the phases of these signals (the relative position of the crests and the troughs in the signal) is called Synchronization. If the signals are not synchronized, flickering, blurriness, and horizontal interference occur.

<b>Tracking</b>	The signals output from computers have a specific frequency. If the projector frequency does not match this frequency, the resulting images are not of a good quality. The process of matching the frequency of these signals (the number of crests in the signal) is called Tracking. If Tracking is not carried out correctly, wide vertical stripes appear in the signal.
<b>Trap IP Address</b>	This is the <a href="#">IP Address</a> for the destination computer used for error notification in SNMP.
<b>Progressive</b>	A method of image scanning whereby the image data from a single image is scanned sequentially from top to bottom to create a single image.
<b>Refresh Rate</b>	The light-emitting element of a display maintains the same luminosity and color for an extremely short time. Because of this, the image must be scanned many times per second to refresh the light-emitting element. The number of refresh operations per second is called the Refresh Rate and is expressed in hertz (Hz).

## General Notes

---

## About Notations

Microsoft® Windows® 2000 operating system

Microsoft® Windows® XP Professional operating system

Microsoft® Windows® XP Home Edition operating system

Microsoft® Windows Vista® operating system

Microsoft® Windows® 7 operating system

In this guide, the operating systems above are referred to as "Windows 2000," "Windows XP," "Windows Vista," and "Windows 7". Furthermore, the collective term Windows may be used to refer to Windows 2000, Windows XP, Windows Vista, and Windows 7, and multiple versions of Windows may be referred to as, for example, Windows 2000/XP/Vista, with the Windows notation omitted.

Mac OS X 10.3.x

Mac OS X 10.4.x

Mac OS X 10.5.x

Mac OS X 10.6.x

Mac OS X 10.7.x

In this guide, the operating systems above are referred to as "Mac OS X 10.3.9," "Mac OS X 10.4.x," "Mac OS X 10.5.x," "Mac OS X 10.6.x" and "Mac OS X 10.7.x". Furthermore, the collective term "Mac OS" is used to refer to them.

---

## Recycling

Epson offers a recycling program for end of life products. Please go to [www.epson.com/recycle](http://www.epson.com/recycle) for information on how to return your products for proper disposal.

---

## Important Safety Instructions

- Do not look into the lens when the projector is on. The bright light can damage your eyes.

- Do not carry the projector by yourself. Two people should use the handles to carry the projector when unpacking or moving it.
- Do not place the projector on an unstable cart, stand, or table. When projecting images vertically, install the projector correctly and appropriately to prevent it from turning over and falling.
- Do not operate the projector on its side, while tilted to one side, or upside down. Do not tilt the projector forward or back at a greater angle than that specified for vertical keystone correction. 🖱️ [p.166](#)
- If the projector is mounted on a ceiling, it should be installed by qualified technicians using mounting hardware designed for use with this projector. Also, when mounting the projector on the ceiling, make sure to pass a wire through the handles to prevent it from falling.
- If you use a ceiling mount and apply adhesives to the mount to prevent the screws from loosening, or if you use lubricants or oils on the projector, the projector case may crack and the projector may fall from its ceiling mount. This could cause serious injury to anyone under the mount and could damage the projector. When installing or adjusting a ceiling mount, do not use adhesives to prevent the screws from loosening and do not use oils or lubricants.
- Do not stand on the projector or place heavy objects on it.
- Do not use the projector where it may be exposed to rain, water, or excessive humidity.
- Unplug the projector from the wall outlet before cleaning. Use a dry cloth (or, for stubborn dirt or stains, a moist cloth that has been wrung dry) for cleaning. Do not use liquid, aerosol cleaners, or solvents such as alcohol, thinner or benzene.
- Do not use any spray containing a flammable gas to remove dirt or dust that is adhering to parts such as the lens or filter of the projector.
- Contact your dealer to clean the interior of the projector. If the interior of the projector has not been cleaned for a long time, dust may build up, which could cause fire or electric shock.
- Never spill liquid of any kind into the projector.
- Do not use the projector where it may be exposed to excessive dust or smoke.
- Do not use the projector where it may be exposed to flammable, corrosive, or explosive gases. Because the lamp inside the projector becomes very hot during use, the gases may ignite and result in a fire.
- Never push objects of any kind through the cabinet slots or openings.
- Do not use or store the projector or remote control in a hot location, such as near a heater, in direct sunlight, or in a closed vehicle.
- Incorrect battery usage may cause leakage of battery fluid and battery rupture, which could result in fire, injury or corrosion of the projector. When replacing batteries, take the following precautions: Insert batteries so that the polarities (+ and -) are correct, do not use batteries of different types, do not mix old and new batteries, and do not use any batteries other than those specified in this User's Guide. Replace the batteries as soon as they run out and remove the batteries if you will not be using the projector for a long period of time. Do not expose batteries to heat or flame and do not put them in water. Dispose of used batteries according to local regulations. Keep these batteries out of the reach of children. Batteries are choking hazards and are very dangerous if swallowed. If the batteries leak, wipe away battery fluid with a soft cloth. If battery fluid gets on your hands, wash them immediately.

- Do not use or store the projector in places where high and low temperature extremes occur, or where the temperature can change suddenly.
- Do not set up the projector in places where it might be subjected to vibration or shock.
- Do not set up the projector near high-voltage electrical wires or sources of magnetic fields.
- Do not store the projector standing on its side.
- Do not block the slots and openings in the projector case. They provide ventilation and prevent the projector from overheating. If you are setting up the projector near a wall, leave at least 19.7 inches (50 cm) of space between the wall and the air exhaust vent.
- Do not operate the projector in a closed-in cabinet unless proper ventilation is provided.
- You may need to clean the air filter and intake vent. A clogged air filter or vent can block ventilation needed to cool the projector.
- Do not use or store the projector outdoors for an extended length of time.
- Do not use the projector outside the required temperature range (👉 p.203). Doing so may cause an unstable display and could lead to projector damage.
- Do not store the projector outside the required temperature range (👉 p.203) or in direct sunlight for long periods of time. Doing so may cause damage to the case.
- Do not touch the plug during an electrical storm. Otherwise, you may receive an electric shock.
- Unplug the projector when it will not be used for extended periods. Place the projector near an outlet where the plug can be easily unplugged.
- Unplug the projector from the wall outlet and refer servicing to qualified service personnel under the following conditions: If it does not operate normally when you follow the operating instructions, or exhibits a distinct change in performance; If smoke, strange odors, or strange noises come from the projector; If the power cord or plug is damaged or frayed; If liquid or foreign objects get inside the projector, or if it has been exposed to rain or water; If it has been dropped or the housing has been damaged.
- Except as specifically explained in this User's Guide, do not attempt to service this product yourself. Refer all servicing to qualified personnel. Opening or removing covers may expose you to dangerous voltages and other hazards.
- Never open any covers on the projector except as specifically explained in this User's Guide. Never attempt to disassemble or modify the projector. Refer all repairs to qualified service personnel.
- Use the type of power source indicated on the projector. Use of a different power source may result in fire or electric shock. If you are not sure of the power available, consult your dealer or power company.
- If you use the projector in the country where it was purchased, only use the power cable that came with the projector. If you use the projector in a country other than where you purchased it, use the correct power cord for that country.
- Do not overload wall outlets, extension cords, or power strips. Do not insert the plug into a dusty outlet. This can cause fire or electric shock.

- Take the following precautions when handling the plug: Do not hold the plug with wet hands. Insert the plug firmly into the outlet. Do not pull the power cord when disconnecting the plug; always be sure to hold the plug when disconnecting it. Failure to comply with these precautions could result in fire or electric shock.
- Do not place the projector where the cord can be walked on.
-  The lamp(s) in this product contain mercury. Please consult your state and local regulations regarding disposal or recycling. Do not put in the trash.
- Do not place anything that can become warped or damaged by heat near the exhaust vents. Do not bring your hands or face close to the vents while projection is in progress.
- Do not bring your face close to the projector while it is in use.
- Do not disassemble or damage the lamp or subject it to any impacts.
- Before you move the projector, make sure its power is turned off, the plug is disconnected from the outlet, and all cables are disconnected.
- Do not project images while the detachable lens cover is still attached. Heat may cause the lens cover to melt, and if you touch the lens cover you could get burned.
- Do not touch the lens with bare hands.
- Always attach the lens cover to the lens when not using the projector, to prevent the lens from becoming dirty or damaged.
- Never try to remove the lamp immediately after use because it will be extremely hot. Before removing the lamp, turn off the power and wait at least an hour to allow the lamp to cool completely.
- Do not place the source of an open flame, such as a lit candle, on or near the projector.
- Do not modify the power cord. Do not place heavy objects on top of the power cord or bend, twist, or pull it excessively. Keep the power cord away from hot electrical appliances.
- If the lamp breaks, ventilate the room to prevent gases contained in the lamp from being inhaled or coming in contact with your eyes or mouth. If you do inhale gases or gases come in contact with your eyes or mouth, seek medical advice immediately.
- If the projector is mounted overhead and the lamp breaks, be careful to prevent pieces of glass from falling into your eyes when you open the lamp cover.

**WARNING:** The cords included with this product contain chemicals, including lead, known to the State of California to cause birth defects or other reproductive harm. ***Wash hands after handling.*** (This notice is provided in accordance with Proposition 65 in Cal. Health & Safety Code § 25249.5 and following.)

## Restriction of Use

When this product is used for applications requiring high reliability/safety such as transportation devices related to aviation, rail, marine, automotive; disaster prevention devices; various safety devices; or functional/precision devices, you should use this product only after giving consideration to including failsafes and redundancies into your design to maintain safety and total system reliability.

Because this product was not intended for use in applications requiring extremely high reliability/safety such as aerospace equipment, main communication equipment, nuclear power control equipment, or medical equipment related to direct medical care, please make your own judgment on this product's suitability after a full evaluation.

---

## FCC Compliance Statement

### For United States Users

This equipment has been tested and found to comply with the limits for a Class B digital device, pursuant to Part 15 of the FCC Rules. These limits are designed to provide reasonable protection against harmful interference in a residential installation. This equipment generates, uses and can radiate radio frequency energy and, if not installed and used in accordance with the instructions, may cause harmful interference to radio communications. However, there is no guarantee that interference will not occur in a particular installation. If this equipment does cause harmful interference to radio or television reception, which can be determined by turning the equipment off and on, the user is encouraged to try to correct the interference by one or more of the following measures:

- Reorient or relocate the receiving antenna.
- Increase the separation between the equipment and receiver.
- Connect the equipment into an outlet on a circuit different from that to which the receiver is connected.
- Consult the dealer or an experienced radio/TV technician for help.

### WARNING:

*The connection of a non-shielded equipment interface cable to this equipment will invalidate the FCC Certification or Declaration of this device and may cause interference levels which exceed the limits established by the FCC for this equipment. It is the responsibility of the user to obtain and use a shielded equipment interface cable with this device. If this equipment has more than one interface connector, do not leave cables connected to unused interfaces. Changes or modifications not expressly approved by the manufacturer could void the user's authority to operate the equipment.*

## For Canadian Users

This Class B digital apparatus meets all requirements of the Canadian Interference-Causing Equipment Regulations.

*Cet appareil numérique de la classe B respecte toutes les exigences du Règlement sur le matériel brouilleur du Canada.*

---

## Wireless Telegraphy Act Regulations

The following acts are prohibited by the Wireless Telegraphy Act:

- Modifying and disassembling (including the antenna)
- Removing the label of conformance

---

## Software Copyright

### GNU GPL

This projector product includes the open source software programs which apply the GNU General Public License Version 2 or later version ("GPL Programs").

We provide the source code of the GPL Programs until five (5) years after the discontinuation of same model of this projector product.

If you desire to receive the source code of the GPL Programs, contact Epson as described in the *User's Guide*.

These GPL Programs are WITHOUT ANY WARRANTY; without even the implied warranty of MERCHANTABILITY AND FITNESS FOR A PARTICULAR PURPOSE.

See the GNU General Public License for more details.

The list of GPL Programs is as follows and the names of author are described in the source code of the GPL Programs

The list of GPL Programs

- **busybox-1.13.4**
- **iptables-1.4.4**
- **libgcc1(gcc-4.3.3)**
- **libstdc++-6.0.10**



- **linux-2.6.27**
- **patches**
- **udhcp 0.9.8**
- **uvc rev.219**
- **wireless\_tools 29**
- **EPSON original drivers**

The GNU General Public License Version 2 is as follows. You also can see the GNU General Public License Version 2 at <http://www.gnu.org/licenses>.

### **GNU GENERAL PUBLIC LICENSE**

Version 2, June 1991

Copyright (C) 1989, 1991 Free Software Foundation, Inc., 51 Franklin Street, Fifth Floor, Boston, MA 02110-1301 USA Everyone is permitted to copy and distribute verbatim copies of this license document, but changing it is not allowed.

#### Preamble

The licenses for most software are designed to take away your freedom to share and change it. By contrast, the GNU General Public License is intended to guarantee your freedom to share and change free software--to make sure the software is free for all its users. This General Public License applies to most of the Free Software Foundation's software and to any other program whose authors commit to using it. (Some other Free Software Foundation software is covered by the GNU Lesser General Public License instead.) You can apply it to your programs, too.

When we speak of free software, we are referring to freedom, not price. Our General Public Licenses are designed to make sure that you have the freedom to distribute copies of free software (and charge for this service if you wish), that you receive source code or can get it if you want it, that you can change the software or use pieces of it in new free programs; and that you know you can do these things.

To protect your rights, we need to make restrictions that forbid anyone to deny you these rights or to ask you to surrender the rights. These restrictions translate to certain responsibilities for you if you distribute copies of the software, or if you modify it.

For example, if you distribute copies of such a program, whether gratis or for a fee, you must give the recipients all the rights that you have. You must make sure that they, too, receive or can get the source code. And you must show them these terms so they know their rights.

We protect your rights with two steps: (1) copyright the software, and (2) offer you this license which gives you legal permission to copy, distribute and/or modify the software.

Also, for each author's protection and ours, we want to make certain that everyone understands that there is no warranty for this free software. If the software is modified by someone else and passed on, we want its recipients to know that what they have is not the original, so that any problems introduced by others will not reflect on the original authors' reputations.

Finally, any free program is threatened constantly by software patents. We wish to avoid the danger that redistributors of a free program will individually obtain patent licenses, in effect making the program proprietary. To prevent this, we have made it clear that any patent must be licensed for everyone's free use or not licensed at all.

The precise terms and conditions for copying, distribution and modification follow.

### **GNU GENERAL PUBLIC LICENSE TERMS AND CONDITIONS FOR COPYING, DISTRIBUTION AND MODIFICATION**

0. This License applies to any program or other work which contains a notice placed by the copyright holder saying it may be distributed under the terms of this General Public License. The "Program", below, refers to any such program or work, and a "work based on the Program" means either the Program or any derivative work under copyright law: that is to say, a work containing the Program or a portion of it, either verbatim or with modifications and/or translated into another language. (Hereinafter, translation is included without limitation in the term "modification".) Each licensee is addressed as "you".

Activities other than copying, distribution and modification are not covered by this License; they are outside its scope. The act of running the Program is not restricted, and the output from the Program is covered only if its contents constitute a work based on the Program (independent of having been made by running the Program). Whether that is true depends on what the Program does.

1. You may copy and distribute verbatim copies of the Program's source code as you receive it, in any medium, provided that you conspicuously and appropriately publish on each copy an appropriate copyright notice and disclaimer of warranty; keep intact all the notices that refer to this License and to the absence of any warranty; and give any other recipients of the Program a copy of this License along with the Program.

You may charge a fee for the physical act of transferring a copy, and you may at your option offer warranty protection in exchange for a fee.

2. You may modify your copy or copies of the Program or any portion of it, thus forming a work based on the Program, and copy and distribute such modifications or work under the terms of Section 1 above, provided that you also meet all of these conditions:

- a) You must cause the modified files to carry prominent notices stating that you changed the files and the date of any change.
- b) You must cause any work that you distribute or publish, that in whole or in part contains or is derived from the Program or any part thereof, to be licensed as a whole at no charge to all third parties under the terms of this License.
- c) If the modified program normally reads commands interactively when run, you must cause it, when started running for such interactive use in the most ordinary way, to print or display an announcement including an appropriate copyright notice and a notice that there is no warranty (or else, saying that you provide a warranty) and that users may redistribute the program under these conditions, and telling the user how to view a copy of this License. (Exception: if the Program itself is interactive but does not normally print such an announcement, your work based on the Program is not required to print an announcement.)

These requirements apply to the modified work as a whole. If identifiable sections of that work are not derived from the Program, and can be reasonably considered independent and separate works in themselves, then this License, and its terms, do not apply to those sections when you distribute them as separate works. But when you distribute the same sections as part of a whole which is a work based on the Program, the distribution of the whole must be on the terms of this License, whose permissions for other licensees extend to the entire whole, and thus to each and every part regardless of who wrote it.

Thus, it is not the intent of this section to claim rights or contest your rights to work written entirely by you; rather, the intent is to exercise the right to control the distribution of derivative or collective works based on the Program.

In addition, mere aggregation of another work not based on the Program with the Program (or with a work based on the Program) on a volume of a storage or distribution medium does not bring the other work under the scope of this License.

3. You may copy and distribute the Program (or a work based on it, under Section 2) in object code or executable form under the terms of Sections 1 and 2 above provided that you also do one of the following:

- a) Accompany it with the complete corresponding machine-readable source code, which must be distributed under the terms of Sections 1 and 2 above on a medium customarily used for software interchange; or,
- b) Accompany it with a written offer, valid for at least three years, to give any third party, for a charge no more than your cost of physically performing source distribution, a complete machine-readable copy of the corresponding source code, to be distributed under the terms of Sections 1 and 2 above on a medium customarily used for software interchange; or,
- c) Accompany it with the information you received as to the offer to distribute corresponding source code. (This alternative is allowed only for noncommercial distribution and only if you received the program in object code or executable form with such an offer, in accord with Subsection b above.)

The source code for a work means the preferred form of the work for making modifications to it. For an executable work, complete source code means all the source code for all modules it contains, plus any associated interface definition files, plus the scripts used to control compilation and installation of the executable. However, as a special exception, the source code distributed need not include anything that is normally distributed (in either source or binary form) with the major components (compiler, kernel, and so on) of the operating system on which the executable runs, unless that component itself accompanies the executable.

If distribution of executable or object code is made by offering access to copy from a designated place, then offering equivalent access to copy the source code from the same place counts as distribution of the source code, even though third parties are not compelled to copy the source along with the object code.

4. You may not copy, modify, sublicense, or distribute the Program except as expressly provided under this License. Any attempt otherwise to copy, modify, sublicense or distribute the Program is void, and will automatically terminate your rights under this License. However, parties who have received copies, or rights, from you under this License will not have their licenses terminated so long as such parties remain in full compliance.

5. You are not required to accept this License, since you have not signed it. However, nothing else grants you permission to modify or distribute the Program or its derivative works. These actions are prohibited by law if you do not accept this License. Therefore, by modifying or distributing the Program (or any work based on the Program), you indicate your acceptance of this License to do so, and all its terms and conditions for copying, distributing or modifying the Program or works based on it.

6. Each time you redistribute the Program (or any work based on the Program), the recipient automatically receives a license from the original licensor to copy, distribute or modify the Program subject to these terms and conditions. You may not impose any further restrictions on the recipients' exercise of the rights granted herein. You are not responsible for enforcing compliance by third parties to this License.

7. If, as a consequence of a court judgment or allegation of patent infringement or for any other reason (not limited to patent issues), conditions are imposed on you (whether by court order, agreement or otherwise) that contradict the conditions of this License, they do not excuse you from the conditions of this License. If you cannot distribute so as to satisfy simultaneously your obligations under this License and any other pertinent obligations, then as a consequence you may not distribute the Program at all. For example, if a patent license would not permit royalty-free redistribution of the Program by all those who receive copies directly or indirectly through you, then the only way you could satisfy both it and this License would be to refrain entirely from distribution of the Program.

If any portion of this section is held invalid or unenforceable under any particular circumstance, the balance of the section is intended to apply and the section as a whole is intended to apply in other circumstances.

It is not the purpose of this section to induce you to infringe any patents or other property right claims or to contest validity of any such claims; this section has the sole purpose of protecting the integrity of the free software distribution system, which is implemented by public license practices. Many people have made generous contributions to the wide range of software distributed through that system in reliance on consistent application of that system; it is up to the author/ donor to decide if he or she is willing to distribute software through any other system and a licensee cannot impose that choice.

This section is intended to make thoroughly clear what is believed to be a consequence of the rest of this License.

8. If the distribution and/or use of the Program is restricted in certain countries either by patents or by copyrighted interfaces, the original copyright holder who places the Program under this License may add an explicit geographical distribution limitation excluding those countries, so that distribution is permitted only in or among countries not thus excluded. In such case, this License incorporates the limitation as if written in the body of this License.

9. The Free Software Foundation may publish revised and/or new versions of the General Public License from time to time. Such new versions will be similar in spirit to the present version, but may differ in detail to address new problems or concerns.

Each version is given a distinguishing version number. If the Program specifies a version number of this License which applies to it and "any later version", you have the option of following the terms and conditions either of that version or of any later version published by the Free Software Foundation. If the Program does not specify a version number of this License, you may choose any version ever published by the Free Software Foundation.

10. If you wish to incorporate parts of the Program into other free programs whose distribution conditions are different, write to the author to ask for permission. For software which is copyrighted by the Free Software Foundation, write to the Free Software Foundation; we sometimes make exceptions for this. Our decision will be guided by the two goals of preserving the free status of all derivatives of our free software and of promoting the sharing and reuse of software generally.

**NO WARRANTY**

11. BECAUSE THE PROGRAM IS LICENSED FREE OF CHARGE, THERE IS NO WARRANTY FOR THE PROGRAM, TO THE EXTENT PERMITTED BY APPLICABLE LAW. EXCEPT WHEN OTHERWISE STATED IN WRITING THE COPYRIGHT HOLDERS AND/OR OTHER PARTIES PROVIDE THE PROGRAM "AS IS" WITHOUT WARRANTY OF ANY KIND, EITHER EXPRESSED OR IMPLIED, INCLUDING, BUT NOT LIMITED TO, THE IMPLIED WARRANTIES OF MERCHANTABILITY AND FITNESS FOR A PARTICULAR PURPOSE. THE ENTIRE RISK AS TO THE QUALITY AND PERFORMANCE OF THE PROGRAM IS WITH YOU. SHOULD THE PROGRAM PROVE DEFECTIVE, YOU ASSUME THE COST OF ALL NECESSARY SERVICING, REPAIR OR CORRECTION.

12. IN NO EVENT UNLESS REQUIRED BY APPLICABLE LAW OR AGREED TO IN WRITING WILL ANY COPYRIGHT HOLDER, OR ANY OTHER PARTY WHO MAY MODIFY AND/OR REDISTRIBUTE THE PROGRAM AS PERMITTED ABOVE, BE LIABLE TO YOU FOR DAMAGES, INCLUDING ANY GENERAL, SPECIAL, INCIDENTAL OR CONSEQUENTIAL DAMAGES ARISING OUT OF THE USE OR INABILITY TO USE THE PROGRAM (INCLUDING BUT NOT LIMITED TO LOSS OF DATA OR DATA BEING RENDERED INACCURATE OR LOSSES SUSTAINED BY YOU OR THIRD PARTIES OR A FAILURE OF THE PROGRAM TO OPERATE WITH ANY OTHER PROGRAMS), EVEN IF SUCH HOLDER OR OTHER PARTY HAS BEEN ADVISED OF THE POSSIBILITY OF SUCH DAMAGES.

## END OF TERMS AND CONDITIONS

### How to Apply These Terms to Your New Programs

If you develop a new program, and you want it to be of the greatest possible use to the public, the best way to achieve this is to make it free software which everyone can redistribute and change under these terms.

To do so, attach the following notices to the program. It is safest to attach them to the start of each source file to most effectively convey the exclusion of warranty; and each file should have at least the "copyright" line and a pointer to where the full notice is found.

<one line to give the program's name and a brief idea of what it does.>

Copyright (C) <year> <name of author>

This program is free software; you can redistribute it and/or modify it under the terms of the GNU General Public License as published by the Free Software Foundation; either version 2 of the License, or (at your option) any later version.

This program is distributed in the hope that it will be useful, but WITHOUT ANY WARRANTY; without even the implied warranty of MERCHANTABILITY or FITNESS FOR A PARTICULAR PURPOSE. See the GNU General Public License for more details.

You should have received a copy of the GNU General Public License along with this program; if not, write to the Free Software Foundation, Inc., 51 Franklin Street, Fifth Floor, Boston, MA 02110-1301 USA.

Also add information on how to contact you by electronic and paper mail.

If the program is interactive, make it output a short notice like this when it starts in an interactive mode:

Gnomovision version 69, Copyright (C) year name of author Gnomovision comes with ABSOLUTELY NO WARRANTY; for details type `show w'. This is free software, and you are welcome to redistribute it under certain conditions; type `show c' for details.

The hypothetical commands `show w` and `show c` should show the appropriate parts of the General Public License. Of course, the commands you use may be called something other than `show w` and `show c`; they could even be mouse-clicks or menu items--whatever suits your program.

You should also get your employer (if you work as a programmer) or your school, if any, to sign a "copyright disclaimer" for the program, if necessary. Here is a sample; alter the names:

Yoyodyne, Inc., hereby disclaims all copyright interest in the program `Gnomovision' (which makes passes at compilers) written by James Hacker.

<signature of Ty Coon>, 1 April 1989

Ty Coon, President of Vice

This General Public License does not permit incorporating your program into proprietary programs. If your program is a subroutine library, you may consider it more useful to permit linking proprietary applications with the library. If this is what you want to do, use the GNU Lesser General Public License instead of this License.

### **GNU LGPL**

This projector product includes the open source software programs which apply the GNU Lesser General Public License Version 2 or later version ("LGPL Programs").

We provide the source code of the LGPL Programs until five (5) years after the discontinuation of same model of this projector product.

If you desire to receive the source code of the LGPL Programs, contact Epson as described in the *User's Guide*.

These LGPL Programs are WITHOUT ANY WARRANTY; without even the implied warranty of MERCHANTABILITY AND FITNESS FOR A PARTICULAR PURPOSE. See the GNU General Public License for more details.

The list of LGPL Programs is as follows and the names of author are described in the source code of the LGPL Programs.

LGPL Programs

- **glibc-2.8**
- **SDL-1.2.13**
- **SDL-Image**

The GNU Lesser General Public License Version 2 is as follows. You also can see the GNU Lesser General Public License Version 2 at <http://www.gnu.org/licenses>.

### **GNU LESSER GENERAL PUBLIC LICENSE**

Version 2.1, February 1999

Copyright (C) 1991, 1999 Free Software Foundation, Inc. 51 Franklin Street, Fifth Floor, Boston, MA 02110-1301 USA Everyone is permitted to copy and distribute verbatim copies of this license document, but changing it is not allowed.

[This is the first released version of the Lesser GPL. It also counts as the successor of the GNU Library Public License, version 2, hence the version number 2.1.]

### Preamble

The licenses for most software are designed to take away your freedom to share and change it. By contrast, the GNU General Public Licenses are intended to guarantee your freedom to share and change free software--to make sure the software is free for all its users.

This license, the Lesser General Public License, applies to some specially designated software packages--typically libraries--of the Free Software Foundation and other authors who decide to use it. You can use it too, but we suggest you first think carefully about whether this license or the ordinary General Public License is the better strategy to use in any particular case, based on the explanations below.

When we speak of free software, we are referring to freedom of use, not price. Our General Public Licenses are designed to make sure that you have the freedom to distribute copies of free software (and charge for this service if you wish); that you receive source code or can get it if you want it; that you can change the software and use pieces of it in new free programs; and that you are informed that you can do these things.

To protect your rights, we need to make restrictions that forbid distributors to deny you these rights or to ask you to surrender these rights. These restrictions translate to certain responsibilities for you if you distribute copies of the library or if you modify it.

For example, if you distribute copies of the library, whether gratis or for a fee, you must give the recipients all the rights that we gave you. You must make sure that they, too, receive or can get the source code. If you link other code with the library, you must provide complete object files to the recipients, so that they can relink them with the library after making changes to the library and recompiling it. And you must show them these terms so they know their rights.

We protect your rights with a two-step method: (1) we copyright the library, and (2) we offer you this license, which gives you legal permission to copy, distribute and/or modify the library.

To protect each distributor, we want to make it very clear that there is no warranty for the free library. Also, if the library is modified by someone else and passed on, the recipients should know that what they have is not the original version, so that the original author's reputation will not be affected by problems that might be introduced by others.

Finally, software patents pose a constant threat to the existence of any free program. We wish to make sure that a company cannot effectively restrict the users of a free program by obtaining a restrictive license from a patent holder. Therefore, we insist that any patent license obtained for a version of the library must be consistent with the full freedom of use specified in this license.

Most GNU software, including some libraries, is covered by the ordinary GNU General Public License. This license, the GNU Lesser General Public License, applies to certain designated libraries, and is quite different from the ordinary General Public License. We use this license for certain libraries in order to permit linking those libraries into nonfree programs.

When a program is linked with a library, whether statically or using a shared library, the combination of the two is legally speaking a combined work, a derivative of the original library. The ordinary General Public License therefore permits such linking only if the entire combination fits its criteria of freedom. The Lesser General Public License permits more lax criteria for linking other code with the library.

We call this license the "Lesser" General Public License because it does Less to protect the user's freedom than the ordinary General Public License. It also provides other free software developers Less of an advantage over competing non-free programs. These disadvantages are the reason we use the ordinary General Public License for many libraries. However, the Lesser license provides advantages in certain special circumstances.

For example, on rare occasions, there may be a special need to encourage the widest possible use of a certain library, so that it becomes a de-facto standard. To achieve this, non-free programs must be allowed to use the library. A more frequent case is that a free library does the same job as widely used non-free libraries. In this case, there is little to gain by limiting the free library to free software only, so we use the Lesser General Public License.

In other cases, permission to use a particular library in non-free programs enables a greater number of people to use a large body of free software. For example, permission to use the GNU C Library in non-free programs enables many more people to use the whole GNU operating system, as well as its variant, the GNU/Linux operating system.

Although the Lesser General Public License is Less protective of the users' freedom, it does ensure that the user of a program that is linked with the Library has the freedom and the wherewithal to run that program using a modified version of the Library.

The precise terms and conditions for copying, distribution and modification follow. Pay close attention to the difference between a "work based on the library" and a "work that uses the library". The former contains code derived from the library, whereas the latter must be combined with the library in order to run.

#### **GNU LESSER GENERAL PUBLIC LICENSE TERMS AND CONDITIONS FOR COPYING, DISTRIBUTION AND MODIFICATION**

0. This License Agreement applies to any software library or other program which contains a notice placed by the copyright holder or other authorized party saying it may be distributed under the terms of this Lesser General Public License (also called "this License"). Each licensee is addressed as "you".

A "library" means a collection of software functions and/or data prepared so as to be conveniently linked with application programs (which use some of those functions and data) to form executables.

The "Library", below, refers to any such software library or work which has been distributed under these terms. A "work based on the Library" means either the Library or any derivative work under copyright law: that is to say, a work containing the Library or a portion of it, either verbatim or with modifications and/or translated straightforwardly into another language. (Hereinafter, translation is included without limitation in the term "modification".)

"Source code" for a work means the preferred form of the work for making modifications to it. For a library, complete source code means all the source code for all modules it contains, plus any associated interface definition files, plus the scripts used to control compilation and installation of the library.

Activities other than copying, distribution and modification are not covered by this License; they are outside its scope. The act of running a program using the Library is not restricted, and output from such a program is covered only if its contents constitute a work based on the Library (independent of the use of the Library in a tool for writing it). Whether that is true depends on what the Library does and what the program that uses the Library does.

1. You may copy and distribute verbatim copies of the Library's complete source code as you receive it, in any medium, provided that you conspicuously and appropriately publish on each copy an appropriate copyright notice and disclaimer of warranty; keep intact all the notices that refer to this License and to the absence of any warranty; and distribute a copy of this License along with the Library.



You may charge a fee for the physical act of transferring a copy, and you may at your option offer warranty protection in exchange for a fee.

2. You may modify your copy or copies of the Library or any portion of it, thus forming a work based on the Library, and copy and distribute such modifications or work under the terms of Section 1 above, provided that you also meet all of these conditions:

- a) The modified work must itself be a software library.
- b) You must cause the files modified to carry prominent notices stating that you changed the files and the date of any change.
- c) You must cause the whole of the work to be licensed at no charge to all third parties under the terms of this License.
- d) If a facility in the modified Library refers to a function or a table of data to be supplied by an application program that uses the facility, other than as an argument passed when the facility is invoked, then you must make a good faith effort to ensure that, in the event an application does not supply such function or table, the facility still operates, and performs whatever part of its purpose remains meaningful.

(For example, a function in a library to compute square roots has a purpose that is entirely well-defined independent of the application. Therefore, Subsection 2d requires that any application-supplied function or table used by this function must be optional: if the application does not supply it, the square root function must still compute square roots.)

These requirements apply to the modified work as a whole. If identifiable sections of that work are not derived from the Library, and can be reasonably considered independent and separate works in themselves, then this License, and its terms, do not apply to those sections when you distribute them as separate works. But when you distribute the same sections as part of a whole which is a work based on the Library, the distribution of the whole must be on the terms of this License, whose permissions for other licensees extend to the entire whole, and thus to each and every part regardless of who wrote it.

Thus, it is not the intent of this section to claim rights or contest your rights to work written entirely by you; rather, the intent is to exercise the right to control the distribution of derivative or collective works based on the Library.

In addition, mere aggregation of another work not based on the Library with the Library (or with a work based on the Library) on a volume of a storage or distribution medium does not bring the other work under the scope of this License.

3. You may opt to apply the terms of the ordinary GNU General Public License instead of this License to a given copy of the Library. To do this, you must alter all the notices that refer to this License, so that they refer to the ordinary GNU General Public License, version 2, instead of to this License. (If a newer version than version 2 of the ordinary GNU General Public License has appeared, then you can specify that version instead if you wish.) Do not make any other change in these notices.

Once this change is made in a given copy, it is irreversible for that copy, so the ordinary GNU General Public License applies to all subsequent copies and derivative works made from that copy.

This option is useful when you wish to copy part of the code of the Library into a program that is not a library.

4. You may copy and distribute the Library (or a portion or derivative of it, under Section 2) in object code or executable form under the terms of Sections 1 and 2 above provided that you accompany it with the complete corresponding machinereadable source code, which must be distributed under the terms of Sections 1 and 2 above on a medium customarily used for software interchange.

If distribution of object code is made by offering access to copy from a designated place, then offering equivalent access to copy the source code from the same place satisfies the requirement to distribute the source code, even though third parties are not compelled to copy the source along with the object code.

5. A program that contains no derivative of any portion of the Library, but is designed to work with the Library by being compiled or linked with it, is called a "work that uses the Library". Such a work, in isolation, is not a derivative work of the Library, and therefore falls outside the scope of this License.

However, linking a "work that uses the Library" with the Library creates an executable that is a derivative of the Library (because it contains portions of the Library), rather than a "work that uses the library". The executable is therefore covered by this License. Section 6 states terms for distribution of such executables.

When a "work that uses the Library" uses material from a header file that is part of the Library, the object code for the work may be a derivative work of the Library even though the source code is not. Whether this is true is especially significant if the work can be linked without the Library, or if the work is itself a library. The threshold for this to be true is not precisely defined by law.

If such an object file uses only numerical parameters, data structure layouts and accessors, and small macros and small inline functions (ten lines or less in length), then the use of the object file is unrestricted, regardless of whether it is legally a derivative work. (Executables containing this object code plus portions of the Library will still fall under Section 6.)

Otherwise, if the work is a derivative of the Library, you may distribute the object code for the work under the terms of Section 6. Any executables containing that work also fall under Section 6, whether or not they are linked directly with the Library itself.

6. As an exception to the Sections above, you may also combine or link a "work that uses the Library" with the Library to produce a work containing portions of the Library, and distribute that work under terms of your choice, provided that the terms permit modification of the work for the customer's own use and reverse engineering for debugging such modifications.

You must give prominent notice with each copy of the work that the Library is used in it and that the Library and its use are covered by this License. You must supply a copy of this License. If the work during execution displays copyright notices, you must include the copyright notice for the Library among them, as well as a reference directing the user to the copy of this License. Also, you must do one of these things:

- a) Accompany the work with the complete corresponding machine-readable source code for the Library including whatever changes were used in the work (which must be distributed under Sections 1 and 2 above); and, if the work is an executable linked with the Library, with the complete machine-readable "work that uses the Library", as object code and/or source code, so that the user can modify the Library and then relink to produce a modified executable containing the modified Library. (It is understood that the user who changes the contents of definitions files in the Library will not necessarily be able to recompile the application to use the modified definitions.)
- b) Use a suitable shared library mechanism for linking with the Library. A suitable mechanism is one that (1) uses at run time a copy of the library already present on the user's computer system, rather than copying library functions into the executable, and (2) will operate properly with a modified version of the library, if the user installs one, as long as the modified version is interface-compatible with the version that the work was made with.
- c) Accompany the work with a written offer, valid for at least three years, to give the same user the materials specified in Subsection 6a, above, for a charge no more than the cost of performing this distribution.
- d) If distribution of the work is made by offering access to copy from a designated place, offer equivalent access to copy the above specified materials from the same place.
- e) Verify that the user has already received a copy of these materials or that you have already sent this user a copy.

For an executable, the required form of the "work that uses the Library" must include any data and utility programs needed for reproducing the executable from it. However, as a special exception, the materials to be distributed need not include anything that is normally distributed (in either source or binary form) with the major components (compiler, kernel, and so on) of the operating system on which the executable runs, unless that component itself accompanies the executable.

It may happen that this requirement contradicts the license restrictions of other proprietary libraries that do not normally accompany the operating system. Such a contradiction means you cannot use both them and the Library together in an executable that you distribute.

7. You may place library facilities that are a work based on the Library side-by-side in a single library together with other library facilities not covered by this License, and distribute such a combined library, provided that the separate distribution of the work based on the Library and of the other library facilities is otherwise permitted, and provided that you do these two things:

- a) Accompany the combined library with a copy of the same work based on the Library, uncombined with any other library facilities. This must be distributed under the terms of the Sections above.
- b) Give prominent notice with the combined library of the fact that part of it is a work based on the Library, and explaining where to find the accompanying uncombined form of the same work.

8. You may not copy, modify, sublicense, link with, or distribute the Library except as expressly provided under this License. Any attempt otherwise to copy, modify, sublicense, link with, or distribute the Library is void, and will automatically terminate your rights under this License. However, parties who have received copies, or rights, from you under this License will not have their licenses terminated so long as such parties remain in full compliance.

9. You are not required to accept this License, since you have not signed it. However, nothing else grants you permission to modify or distribute the Library or its derivative works. These actions are prohibited by law if you do not accept this License. Therefore, by modifying or distributing the Library (or any work based on the Library), you indicate your acceptance of this License to do so, and all its terms and conditions for copying, distributing or modifying the Library or works based on it.

10. Each time you redistribute the Library (or any work based on the Library), the recipient automatically receives a license from the original licensor to copy, distribute, link with or modify the Library subject to these terms and conditions. You may not impose any further restrictions on the recipients' exercise of the rights granted herein. You are not responsible for enforcing compliance by third parties with this License.

11. If, as a consequence of a court judgment or allegation of patent infringement or for any other reason (not limited to patent issues), conditions are imposed on you (whether by court order, agreement or otherwise) that contradict the conditions of this License, they do not excuse you from the conditions of this License. If you cannot distribute so as to satisfy simultaneously your obligations under this License and any other pertinent obligations, then as a consequence you may not distribute the Library at all. For example, if a patent license would not permit royalty-free redistribution of the Library by all those who receive copies directly or indirectly through you, then the only way you could satisfy both it and this License would be to refrain entirely from distribution of the Library.

If any portion of this section is held invalid or unenforceable under any particular circumstance, the balance of the section is intended to apply, and the section as a whole is intended to apply in other circumstances.

It is not the purpose of this section to induce you to infringe any patents or other property right claims or to contest validity of any such claims; this section has the sole purpose of protecting the integrity of the free software distribution system which is implemented by public license practices. Many people have made generous contributions to the wide range of software distributed through that system in reliance on consistent application of that system; it is up to the author/donor to decide if he or she is willing to distribute software through any other system and a licensee cannot impose that choice.

This section is intended to make thoroughly clear what is believed to be a consequence of the rest of this License.

12. If the distribution and/or use of the Library is restricted in certain countries either by patents or by copyrighted interfaces, the original copyright holder who places the Library under this License may add an explicit geographical distribution limitation excluding those countries, so that distribution is permitted only in or among countries not thus excluded. In such case, this License incorporates the limitation as if written in the body of this License.

13. The Free Software Foundation may publish revised and/or new versions of the Lesser General Public License from time to time. Such new versions will be similar in spirit to the present version, but may differ in detail to address new problems or concerns.

Each version is given a distinguishing version number. If the Library specifies a version number of this License which applies to it and "any later version", you have the option of following the terms and conditions either of that version or of any later version published by the Free Software Foundation. If the Library does not specify a license version number, you may choose any version ever published by the Free Software Foundation.

14. If you wish to incorporate parts of the Library into other free programs whose distribution conditions are incompatible with these, write to the author to ask for permission. For software which is copyrighted by the Free Software Foundation, write to the Free Software Foundation; we sometimes make exceptions for this. Our decision will be guided by the two goals of preserving the free status of all derivatives of our free software and of promoting the sharing and reuse of software generally.

#### **NO WARRANTY**

15. BECAUSE THE LIBRARY IS LICENSED FREE OF CHARGE, THERE IS NO WARRANTY FOR THE LIBRARY, TO THE EXTENT PERMITTED BY APPLICABLE LAW. EXCEPT WHEN OTHERWISE STATED IN WRITING THE COPYRIGHT HOLDERS AND/OR OTHER PARTIES PROVIDE THE LIBRARY "AS IS" WITHOUT WARRANTY OF ANY KIND, EITHER EXPRESSED OR IMPLIED, INCLUDING, BUT NOT LIMITED TO, THE IMPLIED WARRANTIES OF MERCHANTABILITY AND FITNESS FOR A PARTICULAR PURPOSE. THE ENTIRE RISK AS TO THE QUALITY AND PERFORMANCE OF THE LIBRARY IS WITH YOU. SHOULD THE LIBRARY PROVE DEFECTIVE, YOU ASSUME THE COST OF ALL NECESSARY SERVICING, REPAIR OR CORRECTION.

16. IN NO EVENT UNLESS REQUIRED BY APPLICABLE LAW OR AGREED TO IN WRITING WILL ANY COPYRIGHT HOLDER, OR ANY OTHER PARTY WHO MAY MODIFY AND/OR REDISTRIBUTE THE LIBRARY AS PERMITTED ABOVE, BE LIABLE TO YOU FOR DAMAGES, INCLUDING ANY GENERAL, SPECIAL, INCIDENTAL OR CONSEQUENTIAL DAMAGES ARISING OUT OF THE USE OR INABILITY TO USE THE LIBRARY (INCLUDING BUT NOT LIMITED TO LOSS OF DATA OR DATA BEING RENDERED INACCURATE OR LOSSES SUSTAINED BY YOU OR THIRD PARTIES OR A FAILURE OF THE LIBRARY TO OPERATE WITH ANY OTHER SOFTWARE), EVEN IF SUCH HOLDER OR OTHER PARTY HAS BEEN ADVISED OF THE POSSIBILITY OF SUCH DAMAGES.

#### **END OF TERMS AND CONDITIONS**

##### How to Apply These Terms to Your New Libraries

If you develop a new library, and you want it to be of the greatest possible use to the public, we recommend making it free software that everyone can redistribute and change. You can do so by permitting redistribution under these terms (or, alternatively, under the terms of the ordinary General Public License).

To apply these terms, attach the following notices to the library. It is safest to attach them to the start of each source file to most effectively convey the exclusion of warranty; and each file should have at least the "copyright" line and a pointer to where the full notice is found.

<one line to give the library's name and a brief idea of what it does.>

Copyright (C) <year> <name of author>

This library is free software; you can redistribute it and/or modify it under the terms of the GNU Lesser General Public License as published by the Free Software Foundation; either version 2.1 of the License, or (at your option) any later version.

This library is distributed in the hope that it will be useful, but WITHOUT ANY WARRANTY; without even the implied warranty of MERCHANTABILITY or FITNESS FOR A PARTICULAR PURPOSE. See the GNU Lesser General Public License for more details.

You should have received a copy of the GNU Lesser General Public License along with this library; if not, write to the Free Software Foundation, Inc., 51 Franklin Street, Fifth Floor, Boston, MA 02110-1301 USA

Also add information on how to contact you by electronic and paper mail.

You should also get your employer (if you work as a programmer) or your school, if any, to sign a "copyright disclaimer" for the library, if necessary. Here is a sample; alter the names:

Yoyodyne, Inc., hereby disclaims all copyright interest in the library 'Frob' (a library for tweaking knobs) written by James Random Hacker.

<signature of Ty Coon>, 1 April 1990

Ty Coon, President of Vice

That's all there is to it!

### **BSD License (Berkeley Software Distribution License)**

This projector product includes the open source software program "University of California, Berkeley License (Berkeley Software Distribution License)" which applies the terms and conditions provided by owner of the copyright to the "BSD License".

The "BSD License" are WITHOUT ANY WARRANTY; without even the implied warranty of MERCHANTABILITY AND FITNESS FOR A PARTICULAR PURPOSE.

List of BSD License programs

#### **busybox-1.13.4**

License terms of conditions of each program which are provided by owner of the copyright to the "BSD License" are as follows.

Copyright (c) The Regents of the University of California. All rights reserved.

This code is derived from software contributed to Berkeley by Kenneth Almquist.

Redistribution and use in source and binary forms, with or without modification, are permitted provided that the following conditions are met:

1. Redistributions of source code must retain the above copyright notice, this list of conditions and the following disclaimer.
2. Redistributions in binary form must reproduce the above copyright notice, this list of conditions and the following disclaimer in the documentation and/or other materials provided with the distribution.
3. Neither the name of the University nor the names of its contributors may be used to endorse or promote products derived from this software without specific prior written permission.

THIS SOFTWARE IS PROVIDED BY THE REGENTS AND CONTRIBUTORS "AS IS" AND ANY EXPRESS OR IMPLIED WARRANTIES, INCLUDING, BUT NOT LIMITED TO, THE IMPLIED WARRANTIES OF MERCHANTABILITY AND FITNESS FOR A PARTICULAR PURPOSE ARE DISCLAIMED. IN NO EVENT SHALL THE REGENTS OR CONTRIBUTORS BE LIABLE FOR ANY DIRECT, INDIRECT, INCIDENTAL, SPECIAL, EXEMPLARY, OR CONSEQUENTIAL DAMAGES (INCLUDING, BUT NOT LIMITED TO, PROCUREMENT OF SUBSTITUTE GOODS OR SERVICES; LOSS OF USE, DATA, OR PROFITS; OR BUSINESS INTERRUPTION) HOWEVER CAUSED AND ON ANY THEORY OF LIABILITY, WHETHER IN CONTRACT, STRICT LIABILITY, OR TORT (INCLUDING NEGLIGENCE OR OTHERWISE) ARISING IN ANY WAY OUT OF THE USE OF THIS SOFTWARE, EVEN IF ADVISED OF THE POSSIBILITY OF SUCH DAMAGE.

### **libjpeg**

This projector product includes the open source software program "libjpeg" which applies the terms and conditions provided by owner of the copyright to the "libjpeg".

The "libjpeg" are WITHOUT ANY WARRANTY; without even the implied warranty of MERCHANTABILITY AND FITNESS FOR A PARTICULAR PURPOSE.

List of libjpeg programs

#### **libjpeg-6b**

License terms of conditions of each program which are provided by owner of the copyright to the "libjpeg" are as follows.

Copyright (C) 1994-1997, Thomas G. Lane. This file is part of the Independent JPEG Group's software. For conditions of distribution and use, see the accompanying README file.

This distribution contains the sixth public release of the Independent JPEG Group's free JPEG software. You are welcome to redistribute this software and to use it for any purpose, subject to the conditions under LEGAL ISSUES, below.

#### LEGAL ISSUES

=====

In plain English:

1. We don't promise that this software works. (But if you find any bugs, please let us know!)
2. You can use this software for whatever you want. You don't have to pay us.

3. You may not pretend that you wrote this software. If you use it in a program, you must acknowledge somewhere in your documentation that you've used the IJG code.

In legalese:

The authors make NO WARRANTY or representation, either express or implied, with respect to this software, its quality, accuracy, merchantability, or fitness for a particular purpose. This software is provided "AS IS", and you, its user, assume the entire risk as to its quality and accuracy.

This software is copyright (C) 1991-1998, Thomas G. Lane. All Rights Reserved except as specified below.

Permission is hereby granted to use, copy, modify, and distribute this software (or portions thereof) for any purpose, without fee, subject to these conditions:

(1) If any part of the source code for this software is distributed, then this README file must be included, with this copyright and no-warranty notice unaltered; and any additions, deletions, or changes to the original files must be clearly indicated in accompanying documentation.

(2) If only executable code is distributed, then the accompanying documentation must state that "this software is based in part on the work of the Independent JPEG Group".

(3) Permission for use of this software is granted only if the user accepts full responsibility for any undesirable consequences; the authors accept NO LIABILITY for damages of any kind.

These conditions apply to any software derived from or based on the IJG code, not just to the unmodified library. If you use our work, you ought to acknowledge us.

Permission is NOT granted for the use of any IJG author's name or company name in advertising or publicity relating to this software or products derived from it. This software may be referred to only as "the Independent JPEG Group's software".

We specifically permit and encourage the use of this software as the basis of commercial products, provided that all warranty or liability claims are assumed by the product vendor.

ansi2knr.c is included in this distribution by permission of L. Peter Deutsch, sole proprietor of its copyright holder, Aladdin Enterprises of Menlo Park, CA. ansi2knr.c is NOT covered by the above copyright and conditions, but instead by the usual distribution terms of the Free Software Foundation; principally, that you must include source code if you redistribute it. (See the file ansi2knr.c for full details.) However, since ansi2knr.c is not needed as part of any program generated from the IJG code, this does not limit you more than the foregoing paragraphs do.

The Unix configuration script "configure" was produced with GNU Autoconf. It is copyright by the Free Software Foundation but is freely distributable. The same holds for its supporting scripts (config.guess, config.sub, ltconfig, ltmain.sh). Another support script, install-sh, is copyright by M.I.T. but is also freely distributable.



It appears that the arithmetic coding option of the JPEG spec is covered by patents owned by IBM, AT&T, and Mitsubishi. Hence arithmetic coding cannot legally be used without obtaining one or more licenses. For this reason, support for arithmetic coding has been removed from the free JPEG software. (Since arithmetic coding provides only a marginal gain over the unpatented Huffman mode, it is unlikely that very many implementations will support it.) So far as we are aware, there are no patent restrictions on the remaining code.

The IJG distribution formerly included code to read and write GIF files. To avoid entanglement with the Unisys LZW patent, GIF reading support has been removed altogether, and the GIF writer has been simplified to produce "uncompressed GIFs". This technique does not use the LZW algorithm; the resulting GIF files are larger than usual, but are readable by all standard GIF decoders.

We are required to state that

"The Graphics Interchange Format(c) is the Copyright property of CompuServe Incorporated. GIF(sm) is a Service Mark property of CompuServe Incorporated."

### **libpng**

This projector product includes the open source software program "libpng" which applies the terms and conditions provided by owner of the copyright to the "libpng".

The "libpng" are WITHOUT ANY WARRANTY; without even the implied warranty of MERCHANTABILITY AND FITNESS FOR A PARTICULAR PURPOSE.

List of libpng programs

- **libpng-1.2.7**
- **libpng-1.2.44**

License terms of conditions of each program which are provided by owner of the copyright to the "libpng" are as follows.

For conditions of distribution and use, see copyright notice in png.h Copyright (c) 1998-2004 Glenn Randers-Pehrson (Version 0.96 Copyright (c) 1996, 1997 Andreas Dilger) (Version 0.88 Copyright (c) 1995, 1996 Guy Eric Schalnat, Group 42, Inc.)

This copy of the libpng notices is provided for your convenience. In case of any discrepancy between this copy and the notices in the file png.h that is included in the libpng distribution, the latter shall prevail.

COPYRIGHT NOTICE, DISCLAIMER, and LICENSE:

If you modify libpng you may insert additional notices immediately following this sentence.

libpng version 1.2.6, September 12, 2004, is Copyright (c) 2004 Glenn Randers-Pehrson, and is distributed according to the same disclaimer and license as libpng-1.2.5 with the following individual added to the list of Contributing Authors

Cosmin Truta

libpng versions 1.0.7, July 1, 2000, through 1.2.5 - October 3, 2002, are Copyright (c) 2000-2002 Glenn Randers-Pehrson, and are distributed according to the same disclaimer and license as libpng-1.0.6 with the following individuals added to the list of Contributing Authors

Simon-Pierre Cadieux

Eric S. Raymond

Gilles Vollant

and with the following additions to the disclaimer:

There is no warranty against interference with your enjoyment of the library or against infringement. There is no warranty that our efforts or the library will fulfill any of your particular purposes or needs. This library is provided with all faults, and the entire risk of satisfactory quality, performance, accuracy, and effort is with the user.

libpng versions 0.97, January 1998, through 1.0.6, March 20, 2000, are Copyright (c) 1998, 1999 Glenn Randers-Pehrson, and are distributed according to the same disclaimer and license as libpng-0.96, with the following individuals added to the list of Contributing Authors:

Tom Lane

Glenn Randers-Pehrson

Willem van Schaik

libpng versions 0.89, June 1996, through 0.96, May 1997, are Copyright (c) 1996, 1997 Andreas Dilger Distributed according to the same disclaimer and license as libpng-0.88, with the following individuals added to the list of Contributing Authors:

John Bowler

Kevin Bracey

Sam Bushell

Magnus Holmgren

Greg Roelofs

Tom Tanner

libpng versions 0.5, May 1995, through 0.88, January 1996, are Copyright (c) 1995, 1996 Guy Eric Schalnat, Group 42, Inc.

For the purposes of this copyright and license, "Contributing Authors" is defined as the following set of individuals:

Andreas Dilger

Dave Martindale

Guy Eric Schalnat

Paul Schmidt

Tim Wegner

The PNG Reference Library is supplied "AS IS". The Contributing Authors and Group 42, Inc. disclaim all warranties, expressed or implied, including, without limitation, the warranties of merchantability and of fitness for any purpose. The Contributing Authors and Group 42, Inc. assume no liability for direct, indirect, incidental, special, exemplary, or consequential damages, which may result from the use of the PNG Reference Library, even if advised of the possibility of such damage.

Permission is hereby granted to use, copy, modify, and distribute this source code, or portions hereof, for any purpose, without fee, subject to the following restrictions:

1. The origin of this source code must not be misrepresented.
2. Altered versions must be plainly marked as such and must not be misrepresented as being the original source.
3. This Copyright notice may not be removed or altered from any source or altered source distribution.

The Contributing Authors and Group 42, Inc. specifically permit, without fee, and encourage the use of this source code as a component to supporting the PNG file format in commercial products. If you use this source code in a product, acknowledgment is not required but would be appreciated.

A "png\_get\_copyright" function is available, for convenient use in "about" boxes and the like:

```
printf("%s",png_get_copyright(NULL));
```

Also, the PNG logo (in PNG format, of course) is supplied in the files "pngbar.png" and "pngbar.jpg (88x31) and "pngnow.png" (98x31).

Libpng is OSI Certified Open Source Software. OSI Certified Open Source is a certification mark of the Open Source Initiative.

Glenn Randers-Pehrson

glennrp@users.sourceforge.net

September 12, 2004

### **zlib**

This projector product includes the open source software program "zlib" which applies the terms and conditions provided by owner of the copyright to the "zlib".

The "zlib" are WITHOUT ANY WARRANTY; without even the implied warranty of MERCHANTABILITY AND FITNESS FOR A PARTICULAR PURPOSE.

List of zlib programs

- **zlib-1.1.4**
- **zlib-1.2.3**

License terms of conditions of each program which are provided by owner of the copyright to the "zlib" are as follows.

Copyright notice:

(C) 1995-1998 Jean-loup Gailly and Mark Adler

This software is provided 'as-is', without any express or implied warranty. In no event will the authors be held liable for any damages arising from the use of this software.

Permission is granted to anyone to use this software for any purpose, including commercial applications, and to alter it and redistribute it freely, subject to the following restrictions:

1. The origin of this software must not be misrepresented; you must not claim that you wrote the original software. If you use this software in a product, an acknowledgment in the product documentation would be appreciated but is not required.
2. Altered source versions must be plainly marked as such, and must not be misrepresented as being the original software.
3. This notice may not be removed or altered from any source distribution.

Jean-loup Gailly  
jloup@gzip.org

Mark Adler  
madler@alumni.caltech.edu

If you use the zlib library in a product, we would appreciate \*not\* receiving lengthy legal documents to sign. The sources are provided for free but without warranty of any kind. The library has been entirely written by Jean-loup Gailly and Mark Adler; it does not include third-party code.

If you redistribute modified sources, we would appreciate that you include in the file ChangeLog history information documenting your changes.

### **mDNSResponder**

This projector product includes the open source software program "mDNSResponder" which applies the following license terms "Apache License Version 2.0, January 2004".

List of "mDNSResponder"

**mDNSResponder-107.6 (only mDNSResponderPosix is used)**

License terms “Apache License Version 2.0, January 2004” are as follows.

Apache License

Version 2.0, January 2004

<http://www.apache.org/licenses/>

## **TERMS AND CONDITIONS FOR USE, REPRODUCTION, AND DISTRIBUTION**

### 1. Definitions.

"License" shall mean the terms and conditions for use, reproduction, and distribution as defined by Sections 1 through 9 of this document.

"Licensor" shall mean the copyright owner or entity authorized by the copyright owner that is granting the License.

"Legal Entity" shall mean the union of the acting entity and all other entities that control, are controlled by, or are under common control with that entity. For the purposes of this definition, "control" means (i) the power, direct or indirect, to cause the direction or management of such entity, whether by contract or otherwise, or (ii) ownership of fifty percent (50%) or more of the outstanding shares, or (iii) beneficial ownership of such entity.

"You" (or "Your") shall mean an individual or Legal Entity exercising permissions granted by this License.

"Source" form shall mean the preferred form for making modifications, including but not limited to software source code, documentation source, and configuration files.

"Object" form shall mean any form resulting from mechanical transformation or translation of a Source form, including but not limited to compiled object code, generated documentation, and conversions to other media types.

"Work" shall mean the work of authorship, whether in Source or Object form, made available under the License, as indicated by a copyright notice that is included in or attached to the work (an example is provided in the Appendix below).

"Derivative Works" shall mean any work, whether in Source or Object form, that is based on (or derived from) the Work and for which the editorial revisions, annotations, elaborations, or other modifications represent, as a whole, an original work of authorship. For the purposes of this License, Derivative Works shall not include works that remain separable from, or merely link (or bind by name) to the interfaces of, the Work and Derivative Works thereof.

"Contribution" shall mean any work of authorship, including the original version of the Work and any modifications or additions to that Work or Derivative Works thereof, that is intentionally submitted to Licensor for inclusion in the Work by the copyright owner or by an individual or Legal Entity authorized to submit on behalf of the copyright owner. For the purposes of this definition, "submitted" means any form of electronic, verbal, or written communication sent to the Licensor or its representatives, including but not limited to communication on electronic mailing lists, source code control systems, and issue tracking systems that are managed by, or on behalf of, the Licensor for the purpose of discussing and improving the Work, but excluding communication that is conspicuously marked or otherwise designated in writing by the copyright owner as "Not a Contribution."

"Contributor" shall mean Licensor and any individual or Legal Entity on behalf of whom a Contribution has been received by Licensor and subsequently incorporated within the Work.

2. Grant of Copyright License. Subject to the terms and conditions of this License, each Contributor hereby grants to You a perpetual, worldwide, non-exclusive, no-charge, royalty-free, irrevocable copyright license to reproduce, prepare Derivative Works of, publicly display, publicly perform, sublicense, and distribute the Work and such Derivative Works in Source or Object form.
3. Grant of Patent License. Subject to the terms and conditions of this License, each Contributor hereby grants to You a perpetual, worldwide, non-exclusive, nocharge, royalty-free, irrevocable (except as stated in this section) patent license to make, have made, use, offer to sell, sell, import, and otherwise transfer the Work, where such license applies only to those patent claims licensable by such Contributor that are necessarily infringed by their Contribution(s) alone or by combination of their Contribution(s) with the Work to which such Contribution(s) was submitted. If You institute patent litigation against any entity (including a cross-claim or counterclaim in a lawsuit) alleging that the Work or a Contribution incorporated within the Work constitutes direct or contributory patent infringement, then any patent licenses granted to You under this License for that Work shall terminate as of the date such litigation is filed.
4. Redistribution. You may reproduce and distribute copies of the Work or Derivative Works thereof in any medium, with or without modifications, and in Source or Object form, provided that You meet the following conditions:
  - (a) You must give any other recipients of the Work or Derivative Works a copy of this License; and
  - (b) You must cause any modified files to carry prominent notices stating that You changed the files; and
  - (c) You must retain, in the Source form of any Derivative Works that You distribute, all copyright, patent, trademark, and attribution notices from the Source form of the Work, excluding those notices that do not pertain to any part of the Derivative Works; and
  - (d) If the Work includes a "NOTICE" text file as part of its distribution, then any Derivative Works that You distribute must include a readable copy of the attribution notices contained within such NOTICE file, excluding those notices that do not pertain to any part of the Derivative Works, in at least one of the following places: within a NOTICE text file distributed as part of the Derivative Works; within the Source form or documentation, if provided along with the Derivative Works; or, within a display generated by theDerivative Works, if and wherever such third-party notices normally appear. The contents of the NOTICE file are for informational purposes only and do not modify the License. You may add Your own attribution notices within Derivative Works that You distribute, alongside or as an addendum to the NOTICE text from the Work, provided that such additional attribution notices cannot be construed as modifying the License.

You may add Your own copyright statement to Your modifications and may provide additional or different license terms and conditions for use, reproduction, or distribution of Your modifications, or for any such Derivative Works as a whole, provided Your use, reproduction, and distribution of the Work otherwise complies with the conditions stated in this License.

5. Submission of Contributions. Unless You explicitly state otherwise, any Contribution intentionally submitted for inclusion in the Work by You to the Licensor shall be under the terms and conditions of this License, without any additional terms or conditions.

Notwithstanding the above, nothing herein shall supersede or modify the terms of any separate license agreement you may have executed with Licensor regarding such Contributions.

6. Trademarks. This License does not grant permission to use the trade names, trademarks, service marks, or product names of the Licensor, except as required for reasonable and customary use in describing the origin of the Work and reproducing the content of the NOTICE file.
7. Disclaimer of Warranty. Unless required by applicable law or agreed to in writing, Licensor provides the Work (and each Contributor provides its Contributions) on an "AS IS" BASIS, WITHOUT WARRANTIES OR CONDITIONS OF ANY KIND, either express or implied, including, without limitation, any warranties or conditions of TITLE, NON-INFRINGEMENT, MERCHANTABILITY, or FITNESS FOR A PARTICULAR PURPOSE. You are solely responsible for determining the appropriateness of using or redistributing the Work and assume any risks associated with Your exercise of permissions under this License.
8. Limitation of Liability. In no event and under no legal theory, whether in tort (including negligence), contract, or otherwise, unless required by applicable law (such as deliberate and grossly negligent acts) or agreed to in writing, shall any Contributor be liable to You for damages, including any direct, indirect, special, incidental, or consequential damages of any character arising as a result of this License or out of the use or inability to use the Work (including but not limited to damages for loss of goodwill, work stoppage, computer failure or malfunction, or any and all other commercial damages or losses), even if such Contributor has been advised of the possibility of such damages.
9. Accepting Warranty or Additional Liability. While redistributing the Work or Derivative Works thereof, You may choose to offer, and charge a fee for, acceptance of support, warranty, indemnity, or other liability obligations and/or rights consistent with this License. However, in accepting such obligations, You may act only on Your own behalf and on Your sole responsibility, not on behalf of any other Contributor, and only if You agree to indemnify, defend, and hold each Contributor harmless for any liability incurred by, or claims asserted against, such Contributor by reason of your accepting any such warranty or additional liability.

## END OF TERMS AND CONDITIONS

APPENDIX: How to apply the Apache License to your work.

To apply the Apache License to your work, attach the following boilerplate notice, with the fields enclosed by brackets "[ ]" replaced with your own identifying information. (Don't include the brackets!) The text should be enclosed in the appropriate comment syntax for the file format. We also recommend that a file or class name and description of purpose be included on the same "printed page" as the copyright notice for easier identification within third-party archives.

Copyright [yyyy] [name of copyright owner]

Licensed under the Apache License, Version 2.0 (the "License"); you may not use this file except in compliance with the License.

You may obtain a copy of the License at

<http://www.apache.org/licenses/LICENSE-2.0>

Unless required by applicable law or agreed to in writing, software distributed under the License is distributed on an "AS IS" BASIS, WITHOUT WARRANTIES OR CONDITIONS OF ANY KIND, either express or implied.

See the License for the specific language governing permissions and limitations under the License.

**newlib**

This projector product includes the open source software program "newlib" which applies the terms and conditions provided by owner of the copyright to the "newlib".

The "newlib" are WITHOUT ANY WARRANTY; without even the implied warranty of MERCHANTABILITY AND FITNESS FOR A PARTICULAR PURPOSE.

List of newlib programs

**newlib 1.17.0**

License terms of conditions of each program which are provided by owner of the copyright to the "newlib" are as follows.

The newlib subdirectory is a collection of software from several sources.

Each file may have its own copyright/license that is embedded in the source file. Unless otherwise noted in the body of the source file(s), the following copyright notices will apply to the contents of the newlib subdirectory:

(1) Red Hat Incorporated

Copyright (c) 1994-2007 Red Hat, Inc. All rights reserved.

This copyrighted material is made available to anyone wishing to use, modify, copy, or redistribute it subject to the terms and conditions of the BSD License. This program is distributed in the hope that it will be useful, but WITHOUT ANY WARRANTY expressed or implied, including the implied warranties of MERCHANTABILITY or FITNESS FOR A PARTICULAR PURPOSE. A copy of this license is available at <http://www.opensource.org/licenses>. Any Red Hat trademarks that are incorporated in the source code or documentation are not subject to the BSD License and may only be used or replicated with the express permission of Red Hat, Inc.

(2) University of California, Berkeley

Copyright (c) 1981-2000 The Regents of the University of California.

All rights reserved.

Redistribution and use in source and binary forms, with or without modification, are permitted provided that the following conditions are met:

- \* Redistributions of source code must retain the above copyright notice, this list of conditions and the following disclaimer.
- \* Redistributions in binary form must reproduce the above copyright notice, this list of conditions and the following disclaimer in the documentation and/or other materials provided with the distribution.
- \* Neither the name of the University nor the names of its contributors may be used to endorse or promote products derived from this software without specific prior written permission.



THIS SOFTWARE IS PROVIDED BY THE COPYRIGHT HOLDERS AND CONTRIBUTORS "AS IS" AND ANY EXPRESS OR IMPLIED WARRANTIES, INCLUDING, BUT NOT LIMITED TO, THE IMPLIED WARRANTIES OF MERCHANTABILITY AND FITNESS FOR A PARTICULAR PURPOSE ARE DISCLAIMED. IN NO EVENT SHALL THE COPYRIGHT OWNER OR CONTRIBUTORS BE LIABLE FOR ANY DIRECT, INDIRECT, INCIDENTAL, SPECIAL, EXEMPLARY, OR CONSEQUENTIAL DAMAGES (INCLUDING, BUT NOT LIMITED TO, PROCUREMENT OF SUBSTITUTE GOODS OR SERVICES; LOSS OF USE, DATA, OR PROFITS; OR BUSINESS INTERRUPTION) HOWEVER CAUSED AND ON ANY THEORY OF LIABILITY, WHETHER IN CONTRACT, STRICT LIABILITY, OR TORT (INCLUDING NEGLIGENCE OR OTHERWISE) ARISING IN ANY WAY OUT OF THE USE OF THIS SOFTWARE, EVEN IF ADVISED OF THE POSSIBILITY OF SUCH DAMAGE.

(3) David M. Gay (AT&T 1991, Lucent 1998)

The author of this software is David M. Gay.

Copyright (c) 1991 by AT&T.

Permission to use, copy, modify, and distribute this software for any purpose without fee is hereby granted, provided that this entire notice is included in all copies of any software which is or includes a copy or modification of this software and in all copies of the supporting documentation for such software.

THIS SOFTWARE IS BEING PROVIDED "AS IS", WITHOUT ANY EXPRESS OR IMPLIED WARRANTY. IN PARTICULAR, NEITHER THE AUTHOR NOR AT&T MAKES ANY REPRESENTATION OR WARRANTY OF ANY KIND CONCERNING THE MERCHANTABILITY OF THIS SOFTWARE OR ITS FITNESS FOR ANY PARTICULAR PURPOSE.

-----

The author of this software is David M. Gay.

Copyright (C) 1998-2001 by Lucent Technologies

All Rights Reserved

Permission to use, copy, modify, and distribute this software and its documentation for any purpose and without fee is hereby granted, provided that the above copyright notice appear in all copies and that both that the copyright notice and this permission notice and warranty disclaimer appear in supporting documentation, and that the name of Lucent or any of its entities not be used in advertising or publicity pertaining to distribution of the software without specific, written prior permission.

LUCENT DISCLAIMS ALL WARRANTIES WITH REGARD TO THIS SOFTWARE, INCLUDING ALL IMPLIED WARRANTIES OF MERCHANTABILITY AND FITNESS. IN NO EVENT SHALL LUCENT OR ANY OF ITS ENTITIES BE LIABLE FOR ANY SPECIAL, INDIRECT OR CONSEQUENTIAL DAMAGES OR ANY DAMAGES WHATSOEVER RESULTING FROM LOSS OF USE, DATA OR PROFITS, WHETHER IN AN ACTION OF CONTRACT, NEGLIGENCE OR OTHER TORTIOUS ACTION, ARISING OUT OF OR IN CONNECTION WITH THE USE OR PERFORMANCE OF THIS SOFTWARE.

(4) Advanced Micro Devices

Copyright 1989, 1990 Advanced Micro Devices, Inc.

This software is the property of Advanced Micro Devices, Inc (AMD) which specifically grants the user the right to modify, use and distribute this software provided this notice is not removed or altered. All other rights are reserved by AMD.

AMD MAKES NO WARRANTY OF ANY KIND, EXPRESS OR IMPLIED, WITH REGARD TO THIS SOFTWARE. IN NO EVENT SHALL AMD BE LIABLE FOR INCIDENTAL OR CONSEQUENTIAL DAMAGES IN CONNECTION WITH OR ARISING FROM THE FURNISHING, PERFORMANCE, OR USE OF THIS SOFTWARE.

So that all may benefit from your experience, please report any problems or suggestions about this software to the 29K Technical Support Center at 800-29-29-AMD (800-292-9263) in the USA, or 0800-89-1131 in the UK, or 0031-11-1129 in Japan, toll free. The direct dial number is 512-462-4118.

Advanced Micro Devices, Inc.

29K Support Products

Mail Stop 573

5900 E. Ben White Blvd.

Austin, TX 78741

800-292-9263

(5) C.W. Sandmann

Copyright (C) 1993 C.W. Sandmann

This file may be freely distributed as long as the author's name remains.

(6) Eric Backus

(C) Copyright 1992 Eric Backus

This software may be used freely so long as this copyright notice is left intact. There is no warrantee on this software.

(7) Sun Microsystems

Copyright (C) 1993 by Sun Microsystems, Inc. All rights reserved.

Developed at SunPro, a Sun Microsystems, Inc. business. Permission to use, copy, modify, and distribute this software is freely granted, provided that this notice is preserved.

(8) Hewlett Packard

(c) Copyright 1986 HEWLETT-PACKARD COMPANY

To anyone who acknowledges that this file is provided "AS IS" without any express or implied warranty: permission to use, copy, modify, and distribute this file for any purpose is hereby granted without fee, provided that the above copyright notice and this notice appears in all copies, and that the name of Hewlett-Packard Company not be used in advertising or publicity pertaining to distribution of the software without specific, written prior permission. Hewlett-Packard Company makes no representations about the suitability of this software for any purpose.

(9) Hans-Peter Nilsson

Copyright (C) 2001 Hans-Peter Nilsson

Permission to use, copy, modify, and distribute this software is freely granted, provided that the above copyright notice, this notice and the following disclaimer are preserved with no changes.

THIS SOFTWARE IS PROVIDED "AS IS" AND WITHOUT ANY EXPRESS OR IMPLIED WARRANTIES, INCLUDING, WITHOUT LIMITATION, THE IMPLIED WARRANTIES OF MERCHANTABILITY AND FITNESS FOR A PARTICULAR PURPOSE.

(11) Christopher G. Demetriou

Copyright (c) 2001 Christopher G. Demetriou

All rights reserved.

Redistribution and use in source and binary forms, with or without modification, are permitted provided that the following conditions are met:

1. Redistributions of source code must retain the above copyright notice, this list of conditions and the following disclaimer.
2. Redistributions in binary form must reproduce the above copyright notice, this list of conditions and the following disclaimer in the documentation and/or other materials provided with the distribution.
3. The name of the author may not be used to endorse or promote products derived from this software without specific prior written permission.

THIS SOFTWARE IS PROVIDED BY THE AUTHOR "AS IS" AND ANY EXPRESS OR IMPLIED WARRANTIES, INCLUDING, BUT NOT LIMITED TO, THE IMPLIED WARRANTIES OF MERCHANTABILITY AND FITNESS FOR A PARTICULAR PURPOSE ARE DISCLAIMED. IN NO EVENT SHALL THE AUTHOR BE LIABLE FOR ANY DIRECT, INDIRECT, INCIDENTAL, SPECIAL, EXEMPLARY, OR CONSEQUENTIAL DAMAGES (INCLUDING, BUT NOT LIMITED TO, PROCUREMENT OF SUBSTITUTE GOODS OR SERVICES; LOSS OF USE, DATA, OR PROFITS; OR BUSINESS INTERRUPTION) HOWEVER CAUSED AND ON ANY THEORY OF LIABILITY, WHETHER IN CONTRACT, STRICT LIABILITY, OR TORT (INCLUDING NEGLIGENCE OR OTHERWISE) ARISING IN ANY WAY OUT OF THE USE OF THIS SOFTWARE, EVEN IF ADVISED OF THE POSSIBILITY OF SUCH DAMAGE.

(12) SuperH, Inc.

Copyright 2002 SuperH, Inc. All rights reserved

This software is the property of SuperH, Inc (SuperH) which specifically grants the user the right to modify, use and distribute this software provided this notice is not removed or altered. All other rights are reserved by SuperH.

SUPERH MAKES NO WARRANTY OF ANY KIND, EXPRESS OR IMPLIED, WITH REGARD TO THIS SOFTWARE. IN NO EVENT SHALL SUPERH BE LIABLE FOR INDIRECT, SPECIAL, INCIDENTAL OR CONSEQUENTIAL DAMAGES IN CONNECTION WITH OR ARISING FROM THE FURNISHING, PERFORMANCE, OR USE OF THIS SOFTWARE.

So that all may benefit from your experience, please report any problems or suggestions about this software to the SuperH Support Center via e-mail at [softwaresupport@superh.com](mailto:softwaresupport@superh.com) .

SuperH, Inc.  
405 River Oaks Parkway  
San Jose  
CA 95134  
USA

(13) Royal Institute of Technology

Copyright (c) 1999 Kungliga Tekniska Högskolan (Royal Institute of Technology, Stockholm, Sweden).

All rights reserved.

Redistribution and use in source and binary forms, with or without modification, are permitted provided that the following conditions are met:

1. Redistributions of source code must retain the above copyright notice, this list of conditions and the following disclaimer.
2. Redistributions in binary form must reproduce the above copyright notice, this list of conditions and the following disclaimer in the documentation and/or other materials provided with the distribution.
3. Neither the name of KTH nor the names of its contributors may be used to endorse or promote products derived from this software without specific prior written permission.

THIS SOFTWARE IS PROVIDED BY KTH AND ITS CONTRIBUTORS "AS IS" AND ANY EXPRESS OR IMPLIED WARRANTIES, INCLUDING, BUT NOT LIMITED TO, THE IMPLIED WARRANTIES OF MERCHANTABILITY AND FITNESS FOR A PARTICULAR PURPOSE ARE DISCLAIMED. IN NO EVENT SHALL KTH OR ITS CONTRIBUTORS BE LIABLE FOR ANY DIRECT, INDIRECT, INCIDENTAL, SPECIAL, EXEMPLARY, OR CONSEQUENTIAL DAMAGES (INCLUDING, BUT NOT LIMITED TO, PROCUREMENT OF SUBSTITUTE GOODS OR SERVICES; LOSS OF USE, DATA, OR PROFITS; OR BUSINESS INTERRUPTION) HOWEVER CAUSED AND ON ANY THEORY OF LIABILITY, WHETHER IN CONTRACT, STRICT LIABILITY, OR TORT (INCLUDING NEGLIGENCE OR OTHERWISE) ARISING IN ANY WAY OUT OF THE USE OF THIS SOFTWARE, EVEN IF ADVISED OF THE POSSIBILITY OF SUCH DAMAGE.

(14) Alexey Zelkin

Copyright (c) 2000, 2001 Alexey Zelkin <[phantom@FreeBSD.org](mailto:phantom@FreeBSD.org)>

All rights reserved.

Redistribution and use in source and binary forms, with or without modification, are permitted provided that the following conditions are met:

1. Redistributions of source code must retain the above copyright notice, this list of conditions and the following disclaimer.
2. Redistributions in binary form must reproduce the above copyright notice, this list of conditions and the following disclaimer in the documentation and/or other materials provided with the distribution.

THIS SOFTWARE IS PROVIDED BY THE AUTHOR AND CONTRIBUTORS "AS IS" AND ANY EXPRESS OR IMPLIED WARRANTIES, INCLUDING, BUT NOT LIMITED TO, THE IMPLIED WARRANTIES OF MERCHANTABILITY AND FITNESS FOR A PARTICULAR PURPOSE ARE DISCLAIMED. IN NO EVENT SHALL THE AUTHOR OR CONTRIBUTORS BE LIABLE FOR ANY DIRECT, INDIRECT, INCIDENTAL, SPECIAL, EXEMPLARY, OR CONSEQUENTIAL DAMAGES (INCLUDING, BUT NOT LIMITED TO, PROCUREMENT OF SUBSTITUTE GOODS OR SERVICES; LOSS OF USE, DATA, OR PROFITS; OR BUSINESS INTERRUPTION) HOWEVER CAUSED AND ON ANY THEORY OF LIABILITY, WHETHER IN CONTRACT, STRICT LIABILITY, OR TORT (INCLUDING NEGLIGENCE OR OTHERWISE) ARISING IN ANY WAY OUT OF THE USE OF THIS SOFTWARE, EVEN IF ADVISED OF THE POSSIBILITY OF SUCH DAMAGE.

(15) Andrey A. Chernov

Copyright (C) 1997 by Andrey A. Chernov, Moscow, Russia.

All rights reserved.

Redistribution and use in source and binary forms, with or without modification, are permitted provided that the following conditions are met:

1. Redistributions of source code must retain the above copyright notice, this list of conditions and the following disclaimer.
2. Redistributions in binary form must reproduce the above copyright notice, this list of conditions and the following disclaimer in the documentation and/or other materials provided with the distribution.

THIS SOFTWARE IS PROVIDED BY THE AUTHOR "AS IS" AND ANY EXPRESS OR IMPLIED WARRANTIES, INCLUDING, BUT NOT LIMITED TO, THE IMPLIED WARRANTIES OF MERCHANTABILITY AND FITNESS FOR A PARTICULAR PURPOSE ARE DISCLAIMED. IN NO EVENT SHALL THE REGENTS OR CONTRIBUTORS BE LIABLE FOR ANY DIRECT, INDIRECT, INCIDENTAL, SPECIAL, EXEMPLARY, OR CONSEQUENTIAL DAMAGES (INCLUDING, BUT NOT LIMITED TO, PROCUREMENT OF SUBSTITUTE GOODS OR SERVICES; LOSS OF USE, DATA, OR PROFITS; OR BUSINESS INTERRUPTION) HOWEVER CAUSED AND ON ANY THEORY OF LIABILITY, WHETHER IN CONTRACT, STRICT LIABILITY, OR TORT (INCLUDING NEGLIGENCE OR OTHERWISE) ARISING IN ANY WAY OUT OF THE USE OF THIS SOFTWARE, EVEN IF ADVISED OF THE POSSIBILITY OF SUCH DAMAGE.

(16) FreeBSD

Copyright (c) 1997-2002 FreeBSD Project.

All rights reserved.

Redistribution and use in source and binary forms, with or without modification, are permitted provided that the following conditions are met:

1. Redistributions of source code must retain the above copyright notice, this list of conditions and the following disclaimer.
2. Redistributions in binary form must reproduce the above copyright notice, this list of conditions and the following disclaimer in the documentation and/or other materials provided with the distribution.

THIS SOFTWARE IS PROVIDED BY THE AUTHOR AND CONTRIBUTORS "AS IS" AND ANY EXPRESS OR IMPLIED WARRANTIES, INCLUDING, BUT NOT LIMITED TO, THE IMPLIED WARRANTIES OF MERCHANTABILITY AND FITNESS FOR A PARTICULAR PURPOSE ARE DISCLAIMED. IN NO EVENT SHALL THE AUTHOR OR CONTRIBUTORS BE LIABLE FOR ANY DIRECT, INDIRECT, INCIDENTAL, SPECIAL, EXEMPLARY, OR CONSEQUENTIAL DAMAGES (INCLUDING, BUT NOT LIMITED TO, PROCUREMENT OF SUBSTITUTE GOODS OR SERVICES; LOSS OF USE, DATA, OR PROFITS; OR BUSINESS INTERRUPTION) HOWEVER CAUSED AND ON ANY THEORY OF LIABILITY, WHETHER IN CONTRACT, STRICT LIABILITY, OR TORT (INCLUDING NEGLIGENCE OR OTHERWISE) ARISING IN ANY WAY OUT OF THE USE OF THIS SOFTWARE, EVEN IF ADVISED OF THE POSSIBILITY OF SUCH DAMAGE.

(17) S. L. Moshier

Author: S. L. Moshier.

Copyright (c) 1984,2000 S.L. Moshier

Permission to use, copy, modify, and distribute this software for any purpose without fee is hereby granted, provided that this entire notice is included in all copies of any software which is or includes a copy or modification of this software and in all copies of the supporting documentation for such software.

THIS SOFTWARE IS BEING PROVIDED "AS IS", WITHOUT ANY EXPRESS OR IMPLIED WARRANTY. IN PARTICULAR, THE AUTHOR MAKES NO REPRESENTATION OR WARRANTY OF ANY KIND CONCERNING THE MERCHANTABILITY OF THIS SOFTWARE OR ITS FITNESS FOR ANY PARTICULAR PURPOSE.

(18) Citrus Project

Copyright (c)1999 Citrus Project,

All rights reserved.

Redistribution and use in source and binary forms, with or without modification, are permitted provided that the following conditions are met:

1. Redistributions of source code must retain the above copyright notice, this list of conditions and the following disclaimer.
2. Redistributions in binary form must reproduce the above copyright notice, this list of conditions and the following disclaimer in the documentation and/or other materials provided with the distribution.

THIS SOFTWARE IS PROVIDED BY THE AUTHOR AND CONTRIBUTORS "AS IS" AND ANY EXPRESS OR IMPLIED WARRANTIES, INCLUDING, BUT NOT LIMITED TO, THE IMPLIED WARRANTIES OF MERCHANTABILITY AND FITNESS FOR A PARTICULAR PURPOSE ARE DISCLAIMED. IN NO EVENT SHALL THE AUTHOR OR CONTRIBUTORS BE LIABLE FOR ANY DIRECT, INDIRECT, INCIDENTAL, SPECIAL, EXEMPLARY, OR CONSEQUENTIAL DAMAGES (INCLUDING, BUT NOT LIMITED TO, PROCUREMENT OF SUBSTITUTE GOODS OR SERVICES; LOSS OF USE, DATA, OR PROFITS; OR BUSINESS INTERRUPTION) HOWEVER CAUSED AND ON ANY THEORY OF LIABILITY, WHETHER IN CONTRACT, STRICT LIABILITY, OR TORT (INCLUDING NEGLIGENCE OR OTHERWISE) ARISING IN ANY WAY OUT OF THE USE OF THIS SOFTWARE, EVEN IF ADVISED OF THE POSSIBILITY OF SUCH DAMAGE.

(19) Todd C. Miller

Copyright (c) 1998 Todd C. Miller <Todd.Miller@courtesan.com>

All rights reserved.

Redistribution and use in source and binary forms, with or without modification, are permitted provided that the following conditions are met:

1. Redistributions of source code must retain the above copyright notice, this list of conditions and the following disclaimer.
2. Redistributions in binary form must reproduce the above copyright notice, this list of conditions and the following disclaimer in the documentation and/or other materials provided with the distribution.
3. The name of the author may not be used to endorse or promote products derived from this software without specific prior written permission.

THIS SOFTWARE IS PROVIDED "AS IS" AND ANY EXPRESS OR IMPLIED WARRANTIES, INCLUDING, BUT NOT LIMITED TO, THE IMPLIED WARRANTIES OF MERCHANTABILITY AND FITNESS FOR A PARTICULAR PURPOSE ARE DISCLAIMED. IN NO EVENT SHALL THE AUTHOR BE LIABLE FOR ANY DIRECT, INDIRECT, INCIDENTAL, SPECIAL, EXEMPLARY, OR CONSEQUENTIAL DAMAGES (INCLUDING, BUT NOT LIMITED TO, PROCUREMENT OF SUBSTITUTE GOODS OR SERVICES; LOSS OF USE, DATA, OR PROFITS; OR BUSINESS INTERRUPTION) HOWEVER CAUSED AND ON ANY THEORY OF LIABILITY, WHETHER IN CONTRACT, STRICT LIABILITY, OR TORT (INCLUDING NEGLIGENCE OR OTHERWISE) ARISING IN ANY WAY OUT OF THE USE OF THIS SOFTWARE, EVEN IF ADVISED OF THE POSSIBILITY OF SUCH DAMAGE.

(20) DJ Delorie (i386)

Copyright (C) 1991 DJ Delorie

All rights reserved.

Redistribution and use in source and binary forms is permitted provided that the above copyright notice and following paragraph are duplicated in all such forms.

This file is distributed WITHOUT ANY WARRANTY; without even the implied warranty of MERCHANTABILITY or FITNESS FOR A PARTICULAR PURPOSE.

(23) Intel (i960)

Copyright (c) 1993 Intel Corporation

Intel hereby grants you permission to copy, modify, and distribute this software and its documentation. Intel grants this permission provided that the above copyright notice appears in all copies and that both the copyright notice and this permission notice appear in supporting documentation. In addition, Intel grants this permission provided that you prominently mark as "not part of the original" any modifications made to this software or documentation, and that the name of Intel Corporation not be used in advertising or publicity pertaining to distribution of the software or the documentation without specific, written prior permission.

Intel Corporation provides this AS IS, WITHOUT ANY WARRANTY, EXPRESS OR IMPLIED, INCLUDING, WITHOUT LIMITATION, ANY WARRANTY OF MERCHANTABILITY OR FITNESS FOR A PARTICULAR PURPOSE. Intel makes no guarantee or representations regarding the use of, or the results of the use of, the software and documentation in terms of correctness, accuracy, reliability, currentness, or otherwise; and you rely on the software, documentation and results solely at your own risk.

IN NO EVENT SHALL INTEL BE LIABLE FOR ANY LOSS OF USE, LOSS OF BUSINESS, LOSS OF PROFITS, INDIRECT, INCIDENTAL, SPECIAL OR CONSEQUENTIAL DAMAGES OF ANY KIND. IN NO EVENT SHALL INTEL'S TOTAL LIABILITY EXCEED THE SUM PAID TO INTEL FOR THE PRODUCT LICENSED HEREUNDER.

(26) Mike Barcroft

Copyright (c) 2001 Mike Barcroft <mike@FreeBSD.org>

All rights reserved.

Redistribution and use in source and binary forms, with or without modification, are permitted provided that the following conditions are met:

1. Redistributions of source code must retain the above copyright notice, this list of conditions and the following disclaimer.
2. Redistributions in binary form must reproduce the above copyright notice, this list of conditions and the following disclaimer in the documentation and/or other materials provided with the distribution.

THIS SOFTWARE IS PROVIDED BY THE AUTHOR AND CONTRIBUTORS "AS IS" AND ANY EXPRESS OR IMPLIED WARRANTIES, INCLUDING, BUT NOT LIMITED TO, THE IMPLIED WARRANTIES OF MERCHANTABILITY AND FITNESS FOR A PARTICULAR PURPOSE ARE DISCLAIMED. IN NO EVENT SHALL THE AUTHOR OR CONTRIBUTORS BE LIABLE FOR ANY DIRECT, INDIRECT, INCIDENTAL, SPECIAL, EXEMPLARY, OR CONSEQUENTIAL DAMAGES (INCLUDING, BUT NOT LIMITED TO, PROCUREMENT OF SUBSTITUTE GOODS OR SERVICES; LOSS OF USE, DATA, OR PROFITS; OR BUSINESS INTERRUPTION) HOWEVER CAUSED AND ON ANY THEORY OF LIABILITY, WHETHER IN CONTRACT, STRICT LIABILITY, OR TORT (INCLUDING NEGLIGENCE OR OTHERWISE) ARISING IN ANY WAY OUT OF THE USE OF THIS SOFTWARE, EVEN IF ADVISED OF THE POSSIBILITY OF SUCH DAMAGE.

(27) Konstantin Chuguev (--enable-newlib-iconv)

Copyright (c) 1999, 2000

Konstantin Chuguev. All rights reserved.

Redistribution and use in source and binary forms, with or without modification, are permitted provided that the following conditions are met:

1. Redistributions of source code must retain the above copyright notice, this list of conditions and the following disclaimer.
2. Redistributions in binary form must reproduce the above copyright notice, this list of conditions and the following disclaimer in the documentation and/or other materials provided with the distribution.



THIS SOFTWARE IS PROVIDED BY THE AUTHOR AND CONTRIBUTORS "AS IS" AND ANY EXPRESS OR IMPLIED WARRANTIES, INCLUDING, BUT NOT LIMITED TO, THE IMPLIED WARRANTIES OF MERCHANTABILITY AND FITNESS FOR A PARTICULAR PURPOSE ARE DISCLAIMED. IN NO EVENT SHALL THE AUTHOR OR CONTRIBUTORS BE LIABLE FOR ANY DIRECT, INDIRECT, INCIDENTAL, SPECIAL, EXEMPLARY, OR CONSEQUENTIAL DAMAGES (INCLUDING, BUT NOT LIMITED TO, PROCUREMENT OF SUBSTITUTE GOODS OR SERVICES; LOSS OF USE, DATA, OR PROFITS; OR BUSINESS INTERRUPTION) HOWEVER CAUSED AND ON ANY THEORY OF LIABILITY, WHETHER IN CONTRACT, STRICT LIABILITY, OR TORT (INCLUDING NEGLIGENCE OR OTHERWISE) ARISING IN ANY WAY OUT OF THE USE OF THIS SOFTWARE, EVEN IF ADVISED OF THE POSSIBILITY OF SUCH DAMAGE.

iconv (Charset Conversion Library) v2.0

(28) Artem Bityuckiy (--enable-newlib-iconv)

Copyright (c) 2003, Artem B. Bityuckiy, SoftMine Corporation. Rights transferred to Franklin Electronic Publishers.

Redistribution and use in source and binary forms, with or without modification, are permitted provided that the following conditions are met:

1. Redistributions of source code must retain the above copyright notice, this list of conditions and the following disclaimer.
2. Redistributions in binary form must reproduce the above copyright notice, this list of conditions and the following disclaimer in the documentation and/or other materials provided with the distribution.

THIS SOFTWARE IS PROVIDED BY THE AUTHOR AND CONTRIBUTORS "AS IS" AND ANY EXPRESS OR IMPLIED WARRANTIES, INCLUDING, BUT NOT LIMITED TO, THE IMPLIED WARRANTIES OF MERCHANTABILITY AND FITNESS FOR A PARTICULAR PURPOSE ARE DISCLAIMED. IN NO EVENT SHALL THE AUTHOR OR CONTRIBUTORS BE LIABLE FOR ANY DIRECT, INDIRECT, INCIDENTAL, SPECIAL, EXEMPLARY, OR CONSEQUENTIAL DAMAGES (INCLUDING, BUT NOT LIMITED TO, PROCUREMENT OF SUBSTITUTE GOODS OR SERVICES; LOSS OF USE, DATA, OR PROFITS; OR BUSINESS INTERRUPTION) HOWEVER CAUSED AND ON ANY THEORY OF LIABILITY, WHETHER IN CONTRACT, STRICT LIABILITY, OR TORT (INCLUDING NEGLIGENCE OR OTHERWISE) ARISING IN ANY WAY OUT OF THE USE OF THIS SOFTWARE, EVEN IF ADVISED OF THE POSSIBILITY OF SUCH DAMAGE.

(30) - Alex Tatmanjants (targets using libc/posix)

Copyright (c) 1995 Alex Tatmanjants <alex@elvisti.kiev.ua>

at Electronni Visti IA, Kiev, Ukraine.

All rights reserved.

Redistribution and use in source and binary forms, with or without modification, are permitted provided that the following conditions are met:

1. Redistributions of source code must retain the above copyright notice, this list of conditions and the following disclaimer.
2. Redistributions in binary form must reproduce the above copyright notice, this list of conditions and the following disclaimer in the documentation and/or other materials provided with the distribution.

THIS SOFTWARE IS PROVIDED BY THE AUTHOR "AS IS" AND ANY EXPRESS OR IMPLIED WARRANTIES, INCLUDING, BUT NOT LIMITED TO, THE IMPLIED WARRANTIES OF MERCHANTABILITY AND FITNESS FOR A PARTICULAR PURPOSE ARE DISCLAIMED. IN NO EVENT SHALL THE AUTHOR BE LIABLE FOR ANY DIRECT, INDIRECT, INCIDENTAL, SPECIAL, EXEMPLARY, OR CONSEQUENTIAL DAMAGES (INCLUDING, BUT NOT LIMITED TO, PROCUREMENT OF SUBSTITUTE GOODS OR SERVICES; LOSS OF USE, DATA, OR PROFITS; OR BUSINESS INTERRUPTION) HOWEVER CAUSED AND ON ANY THEORY OF LIABILITY, WHETHER IN CONTRACT, STRICT LIABILITY, OR TORT (INCLUDING NEGLIGENCE OR OTHERWISE) ARISING IN ANY WAY OUT OF THE USE OF THIS SOFTWARE, EVEN IF ADVISED OF THE POSSIBILITY OF SUCH DAMAGE.

(31) - M. Warner Losh (targets using libc/posix)

Copyright (c) 1998, M. Warner Losh <imp@freebsd.org>

All rights reserved.

Redistribution and use in source and binary forms, with or without modification, are permitted provided that the following conditions are met:

1. Redistributions of source code must retain the above copyright notice, this list of conditions and the following disclaimer.
2. Redistributions in binary form must reproduce the above copyright notice, this list of conditions and the following disclaimer in the documentation and/or other materials provided with the distribution.

THIS SOFTWARE IS PROVIDED BY THE AUTHOR AND CONTRIBUTORS "AS IS" AND ANY EXPRESS OR IMPLIED WARRANTIES, INCLUDING, BUT NOT LIMITED TO, THE IMPLIED WARRANTIES OF MERCHANTABILITY AND FITNESS FOR A PARTICULAR PURPOSE ARE DISCLAIMED. IN NO EVENT SHALL THE AUTHOR OR CONTRIBUTORS BE LIABLE FOR ANY DIRECT, INDIRECT, INCIDENTAL, SPECIAL, EXEMPLARY, OR CONSEQUENTIAL DAMAGES (INCLUDING, BUT NOT LIMITED TO, PROCUREMENT OF SUBSTITUTE GOODS OR SERVICES; LOSS OF USE, DATA, OR PROFITS; OR BUSINESS INTERRUPTION) HOWEVER CAUSED AND ON ANY THEORY OF LIABILITY, WHETHER IN CONTRACT, STRICT LIABILITY, OR TORT (INCLUDING NEGLIGENCE OR OTHERWISE) ARISING IN ANY WAY OUT OF THE USE OF THIS SOFTWARE, EVEN IF ADVISED OF THE POSSIBILITY OF SUCH DAMAGE.

(32) - Andrey A. Chernov (targets using libc/posix)

Copyright (C) 1996 by Andrey A. Chernov, Moscow, Russia.

All rights reserved.

Redistribution and use in source and binary forms, with or without modification, are permitted provided that the following conditions are met:

1. Redistributions of source code must retain the above copyright notice, this list of conditions and the following disclaimer.
2. Redistributions in binary form must reproduce the above copyright notice, this list of conditions and the following disclaimer in the documentation and/or other materials provided with the distribution.

THIS SOFTWARE IS PROVIDED BY THE AUTHOR "AS IS" AND ANY EXPRESS OR IMPLIED WARRANTIES, INCLUDING, BUT NOT LIMITED TO, THE IMPLIED WARRANTIES OF MERCHANTABILITY AND FITNESS FOR A PARTICULAR PURPOSE ARE DISCLAIMED. IN NO EVENT SHALL THE REGENTS OR CONTRIBUTORS BE LIABLE FOR ANY DIRECT, INDIRECT, INCIDENTAL, SPECIAL, EXEMPLARY, OR CONSEQUENTIAL DAMAGES (INCLUDING, BUT NOT LIMITED TO, PROCUREMENT OF SUBSTITUTE GOODS OR SERVICES; LOSS OF USE, DATA, OR PROFITS; OR BUSINESS INTERRUPTION) HOWEVER CAUSED AND ON ANY THEORY OF LIABILITY, WHETHER IN CONTRACT, STRICT LIABILITY, OR TORT (INCLUDING NEGLIGENCE OR OTHERWISE) ARISING IN ANY WAY OUT OF THE USE OF THIS SOFTWARE, EVEN IF ADVISED OF THE POSSIBILITY OF SUCH DAMAGE.

(33) - Daniel Eischen (targets using libc/posix)

Copyright (c) 2001 Daniel Eischen <deischen@FreeBSD.org>.

All rights reserved.

Redistribution and use in source and binary forms, with or without modification, are permitted provided that the following conditions are met:

1. Redistributions of source code must retain the above copyright notice, this list of conditions and the following disclaimer.
2. Redistributions in binary form must reproduce the above copyright notice, this list of conditions and the following disclaimer in the documentation and/or other materials provided with the distribution.

THIS SOFTWARE IS PROVIDED BY THE AUTHOR AND CONTRIBUTORS "AS IS" AND ANY EXPRESS OR IMPLIED WARRANTIES, INCLUDING, BUT NOT LIMITED TO, THE IMPLIED WARRANTIES OF MERCHANTABILITY AND FITNESS FOR A PARTICULAR PURPOSE ARE DISCLAIMED. IN NO EVENT SHALL THE REGENTS OR CONTRIBUTORS BE LIABLE FOR ANY DIRECT, INDIRECT, INCIDENTAL, SPECIAL, EXEMPLARY, OR CONSEQUENTIAL DAMAGES (INCLUDING, BUT NOT LIMITED TO, PROCUREMENT OF SUBSTITUTE GOODS OR SERVICES; LOSS OF USE, DATA, OR PROFITS; OR BUSINESS INTERRUPTION) HOWEVER CAUSED AND ON ANY THEORY OF LIABILITY, WHETHER IN CONTRACT, STRICT LIABILITY, OR TORT (INCLUDING NEGLIGENCE OR OTHERWISE) ARISING IN ANY WAY OUT OF THE USE OF THIS SOFTWARE, EVEN IF ADVISED OF THE POSSIBILITY OF SUCH DAMAGE.

(35) - ARM Ltd (arm and thumb variant targets only)

Copyright (c) 2009 ARM Ltd

All rights reserved.

Redistribution and use in source and binary forms, with or without modification, are permitted provided that the following conditions are met:

1. Redistributions of source code must retain the above copyright notice, this list of conditions and the following disclaimer.
2. Redistributions in binary form must reproduce the above copyright notice, this list of conditions and the following disclaimer in the documentation and/or other materials provided with the distribution.
3. The name of the company may not be used to endorse or promote products derived from this software without specific prior written permission.

THIS SOFTWARE IS PROVIDED BY ARM LTD "AS IS" AND ANY EXPRESS OR IMPLIED WARRANTIES, INCLUDING, BUT NOT LIMITED TO, THE IMPLIED WARRANTIES OF MERCHANTABILITY AND FITNESS FOR A PARTICULAR PURPOSE ARE DISCLAIMED. IN NO EVENT SHALL ARM LTD BE LIABLE FOR ANY DIRECT, INDIRECT, INCIDENTAL, SPECIAL, EXEMPLARY, OR CONSEQUENTIAL DAMAGES (INCLUDING, BUT NOT LIMITED TO, PROCUREMENT OF SUBSTITUTE GOODS OR SERVICES; LOSS OF USE, DATA, OR PROFITS; OR BUSINESS INTERRUPTION) HOWEVER CAUSED AND ON ANY THEORY OF LIABILITY, WHETHER IN CONTRACT, STRICT LIABILITY, OR TORT (INCLUDING NEGLIGENCE OR OTHERWISE) ARISING IN ANY WAY OUT OF THE USE OF THIS SOFTWARE, EVEN IF ADVISED OF THE POSSIBILITY OF SUCH DAMAGE.

(36) - CodeSourcery, Inc.

Copyright (c) 2009 CodeSourcery, Inc.

All rights reserved.

Redistribution and use in source and binary forms, with or without modification, are permitted provided that the following conditions are met:

- \* Redistributions of source code must retain the above copyright notice, this list of conditions and the following disclaimer.
- \* Redistributions in binary form must reproduce the above copyright notice, this list of conditions and the following disclaimer in the documentation and/or other materials provided with the distribution.
- \* Neither the name of CodeSourcery nor the names of its contributors may be used to endorse or promote products derived from this software without specific prior written permission.

THIS SOFTWARE IS PROVIDED BY CODESOURCERY, INC. "AS IS" AND ANY EXPRESS OR IMPLIED WARRANTIES, INCLUDING, BUT NOT LIMITED TO, THE IMPLIED WARRANTIES OF MERCHANTABILITY AND FITNESS FOR A PARTICULAR PURPOSE ARE DISCLAIMED. IN NO EVENT SHALL CODESOURCERY BE LIABLE FOR ANY DIRECT, INDIRECT, INCIDENTAL, SPECIAL, EXEMPLARY, OR CONSEQUENTIAL DAMAGES (INCLUDING, BUT NOT LIMITED TO, PROCUREMENT OF SUBSTITUTE GOODS OR SERVICES; LOSS OF USE, DATA, OR PROFITS; OR BUSINESS INTERRUPTION) HOWEVER CAUSED AND ON ANY THEORY OF LIABILITY, WHETHER IN CONTRACT, STRICT LIABILITY, OR TORT (INCLUDING NEGLIGENCE OR OTHERWISE) ARISING IN ANY WAY OUT OF THE USE OF THIS SOFTWARE, EVEN IF ADVISED OF THE POSSIBILITY OF SUCH DAMAGE.

(37) MIPS Technologies, Inc

/\*

\* Copyright (c) 2009 MIPS Technologies, Inc.

\*

\* All rights reserved.

\*

\* Redistribution and use in source and binary forms, with or without modification, are permitted provided that the following conditions are met:

\*

\* \* Redistributions of source code must retain the above copyright notice, this list of conditions and the following disclaimer.

\* \* Redistributions in binary form must reproduce the above copyright notice, this list of conditions and the following disclaimer in the documentation and/or other materials provided with the distribution.

\* \* Neither the name of MIPS Technologies Inc. nor the names of its contributors may be used to endorse or promote products derived from this software without specific prior written permission.

\* THIS SOFTWARE IS PROVIDED BY THE COPYRIGHT HOLDERS AND CONTRIBUTORS "AS IS" AND ANY EXPRESS OR IMPLIED WARRANTIES, INCLUDING, BUT NOT LIMITED TO, THE IMPLIED WARRANTIES OF MERCHANTABILITY AND FITNESS FOR A PARTICULAR PURPOSE ARE DISCLAIMED. IN NO EVENT SHALL THE COPYRIGHT OWNER OR CONTRIBUTORS BE LIABLE FOR ANY DIRECT, INDIRECT, INCIDENTAL, SPECIAL, EXEMPLARY, OR CONSEQUENTIAL DAMAGES (INCLUDING, BUT NOT LIMITED TO, PROCUREMENT OF SUBSTITUTE GOODS OR SERVICES; LOSS OF USE, DATA, OR PROFITS; OR BUSINESS INTERRUPTION) HOWEVER CAUSED AND ON ANY THEORY OF LIABILITY, WHETHER IN CONTRACT, STRICT LIABILITY, OR TORT (INCLUDING NEGLIGENCE OR OTHERWISE) ARISING IN ANY WAY OUT OF THE USE OF THIS SOFTWARE, EVEN IF ADVISED OF THE POSSIBILITY OF SUCH DAMAGE.

/\*

### **WPA Supplicant**

The copyright owner of the WPA Supplicant open source software provides terms and conditions (hereinafter referred to as "WPA Supplicant License"). The projector uses this product in compliance with the BSD License, as part of the WPA Supplicant License.

The "WPA Supplicant License" is WITHOUT ANY WARRANTY; without even the implied warranty of MERCHANTABILITY AND FITNESS FOR A PARTICULAR PURPOSE.

List of WPA Supplicant License programs

#### **WPA Supplicant-0.7.3**

License terms of conditions of each program which are provided by owner of the copyright to the "WPA Supplicant License" are as follows.

Copyright (c) 2003-2011, Jouni Malinen <j@w1.fi> and contributors All Rights Reserved.

Redistribution and use in source and binary forms, with or without modification, are permitted provided that the following conditions are met:

1. Redistributions of source code must retain the above copyright notice, this list of conditions and the following disclaimer.
2. Redistributions in binary form must reproduce the above copyright notice, this list of conditions and the following disclaimer in the documentation and/or other materials provided with the distribution.

3. Neither the name(s) of the above-listed copyright holder(s) nor the names of its contributors may be used to endorse or promote products derived from this software without specific prior written permission.

THIS SOFTWARE IS PROVIDED BY THE COPYRIGHT HOLDERS AND CONTRIBUTORS "AS IS" AND ANY EXPRESS OR IMPLIED WARRANTIES, INCLUDING, BUT NOT LIMITED TO, THE IMPLIED WARRANTIES OF MERCHANTABILITY AND FITNESS FOR A PARTICULAR PURPOSE ARE DISCLAIMED. IN NO EVENT SHALL THE COPYRIGHT OWNER OR CONTRIBUTORS BE LIABLE FOR ANY DIRECT, INDIRECT, INCIDENTAL, SPECIAL, EXEMPLARY, OR CONSEQUENTIAL DAMAGES (INCLUDING, BUT NOT LIMITED TO, PROCUREMENT OF SUBSTITUTE GOODS OR SERVICES; LOSS OF USE, DATA, OR PROFITS; OR BUSINESS INTERRUPTION) HOWEVER CAUSED AND ON ANY THEORY OF LIABILITY, WHETHER IN CONTRACT, STRICT LIABILITY, OR TORT (INCLUDING NEGLIGENCE OR OTHERWISE) ARISING IN ANY WAY OUT OF THE USE OF THIS SOFTWARE, EVEN IF ADVISED OF THE POSSIBILITY OF SUCH DAMAGE.

**For MPEG-4 ASP:**

With respect to a Licensee offering MPEG-4 Video Decoders and/or Encoders the following notice shall be given: THIS PRODUCT IS LICENSED UNDER THE MPEG-4 VISUAL PATENT PORTFOLIO LICENSE FOR THE PERSONAL AND NONCOMMERCIAL USE OF A CONSUMER FOR (i) ENCODING VIDEO IN COMPLIANCE WITH THE MPEG-4 VISUAL STANDARD ("MPEG-4 VIDEO") AND/OR (ii) DECODING MPEG-4 VIDEO THAT WAS ENCODED BY A CONSUMER ENGAGED IN A PERSONAL AND NON-COMMERCIAL ACTIVITY AND/OR WAS OBTAINED FROM A VIDEO PROVIDER LICENSED BY MPEG LA TO PROVIDE MPEG-4 VIDEO. NO LICENSE IS GRANTED OR SHALL BE IMPLIED FOR ANY OTHER USE. ADDITIONAL INFORMATION INCLUDING THAT RELATING TO PROMOTIONAL, INTERNAL AND COMMERCIAL USES AND LICENSING MAY BE OBTAINED FROM MPEG LA,LLC. SEE [HTTP://WWW.MPEGLA.COM](http://www.mpegla.com).

**For MPEG-4 AVC:**

THIS PRODUCT IS LICENSED UNDER THE AVC PATENT PORTFOLIO LICENSE FOR THE PERSONAL AND NON-COMMERCIAL USE OF A CONSUMER TO (i) ENCODE VIDEO IN COMPLIANCE WITH THE AVC STANDARD ("AVC VIDEO") AND/OR (ii) DECODE AVC VIDEO THAT WAS ENCODED BY A CONSUMER ENGAGED IN A PERSONAL AND NON-COMMERCIAL ACTIVITY AND/OR WAS OBTAINED FROM A VIDEO PROVIDER LICENSED TO PROVIDE AVC VIDEO. NO LICENSE IS GRANTED OR SHALL BE IMPLIED FOR ANY OTHER USE. ADDITIONAL INFORMATION MAY BE OBTAINED FROM MPEG LA, L.L.C. SEE [HTTP://WWW.MPEGLA.COM](http://www.mpegla.com)

**For WMV/WMA (Microsoft):**

This product is protected by certain intellectual property rights of Microsoft.

Use or distribution of such technology outside of this product is prohibited without a license from Microsoft.

**For VC-1**

THIS PRODUCT IS LICENSED UNDER THE VC-1 PATENT PORTFOLIO LICENSE FOR THE PERSONAL AND NON-COMMERCIAL USE OF A CONSUMER TO (i) ENCODE VIDEO IN COMPLIANCE WITH THE VC-1 STANDARD ("VC-1 VIDEO") AND/OR (ii) DECODE VC-1 VIDEO THAT WAS ENCODED BY A CONSUMER ENGAGED IN A PERSONAL AND NONCOMMERCIAL ACTIVITY AND/OR WAS OBTAINED FROM A VIDEO PROVIDER LICENSED TO PROVIDE VC-1 VIDEO. NO LICENSE IS GRANTED OR SHALL BE IMPLIED FOR ANY OTHER USE. ADDITIONAL INFORMATION MAY BE OBTAINED FROM MPEG LA, L.L.C. SEE [HTTP://WWW.MPEGLA.COM](http://www.mpegla.com)

---

## Trademarks

EPSON®, Instant Off®, PowerLite®, and Quick Corner® are registered trademarks, and EPSON Exceed Your Vision is a registered logomark of Seiko Epson Corporation.

PrivateLine® is a registered trademark, and EPSON Store<sup>SM</sup> and Extra Care<sup>SM</sup> are service marks of Epson America, Inc.

Microsoft, Windows, Windows NT, Windows Vista, Windows 7, PowerPoint, and Windows logo are trademarks or registered trademarks of Microsoft Corporation in the United States and/or other countries.

IBM, DOS/V, and XGA are trademarks or registered trademarks of International Business Machines Corp.

Macintosh and Mac are registered trademarks of Apple Inc.

Pixelworks and DNX are trademarks of Pixelworks Inc.

This product includes RSA BSAFE™ software from RSA Security Inc. RSA is a registered trademark of RSA Security Inc. BSAFE RSA Security Inc. is a registered trade mark in the United States and other countries.

WPA™, WPA2™ and Wi-Fi Protected Setup™ are registered trademarks of Wi-Fi Alliance.

PJLink trademark is a trademark applied for registration or is already registered in Japan, the United States of America and other countries and areas.

HDMI and High-Definition Multimedia Interface are the trademarks or registered trademarks of HDMI Licensing LLC.  HIGH DEFINITION MULTIMEDIA INTERFACE

Other product names used herein are also for identification purposes only and may be trademarks of their respective owners. Epson disclaims any and all rights in those marks.

---

## Copyright Notice

All rights reserved. No part of this publication may be reproduced, stored in a retrieval system, or transmitted in any form or by any means, electronic, mechanical, photocopying, recording, or otherwise, without the prior written permission of Seiko Epson Corporation. The information contained herein is designed only for use with this EPSON product. Epson is not responsible for any use of this information as applied to other products.

Neither Seiko Epson Corporation nor its affiliates shall be liable to the purchaser of this product or third parties for damages, losses, costs, or expenses incurred by purchaser or third parties as a result of: accident, misuse, or abuse of this product or unauthorized modifications, repairs, or alterations to this product, or (excluding the U.S.) failure to strictly comply with Seiko Epson Corporation's operating and maintenance instructions.

Seiko Epson Corporation shall not be liable for any damages or problems arising from the use of any options or any consumable products other than those designated as Original EPSON Products or EPSON Approved Products by Seiko Epson Corporation.

This information is subject to change without notice.

## **A Note Concerning Responsible Use of Copyrighted Materials**

Epson encourages each user to be responsible and respectful of the copyright laws when using any EPSON product. While some countries' laws permit limited copying or reuse of copyrighted material in certain circumstances, those circumstances may not be as broad as some people assume. Contact your legal advisor for any questions regarding copyright law.

## **Copyright Attribution**

This information is subject to change without notice.

©2012 Epson America, Inc.

12/12

CPD-36305R1