

**EPSON**<sup>®</sup>  
EXCEED YOUR VISION



# Epson MovieMate™ 72

---

## User's Guide



## Copyright Notice

All rights reserved. No part of this publication may be reproduced, stored in a retrieval system, or transmitted in any form or by any means, electronic, mechanical, photocopying, recording, or otherwise, without the prior written permission of Seiko Epson Corporation. The information contained herein is designed only for use with this Epson product. Epson is not responsible for any use of this information as applied to other products.

Neither Seiko Epson Corporation nor its affiliates shall be liable to the purchaser of this product or third parties for damages, losses, costs, or expenses incurred by purchaser or third parties as a result of: accident, misuse, or abuse of this product or unauthorized modifications, repairs, or alterations to this product, or (excluding the U.S.) failure to strictly comply with Seiko Epson Corporation's operating and maintenance instructions.

Seiko Epson Corporation shall not be liable for any damages or problems arising from the use of any options or any consumable products other than those designated as Original Epson Products or Epson Approved Products by Seiko Epson Corporation.

### Responsible Use

This unit is equipped with Macrovision copy protection. The intellectual property rights to the patent of this copy protection technology are owned by the Macrovision Company of America, and others. When employing this technology, a license is required from the Macrovision Company. The Macrovision Company does not authorize the use of this technology except for a limited range of intended purposes, including home use. Further, remodeling, disassembly, and reverse engineering are prohibited.

Reproduction of a disc for the purposes of broadcast, projection in public, public musical performance, or rental (regardless of compensation, remuneration, or lack thereof) without the permission of the copyright owner, is strictly prohibited. This publication and the features described herein are subject to change without notice.

### Trademarks

Epson is a registered trademark and Epson Exceed Your Vision is a trademark of Seiko Epson Corporation.

Epson MovieMate is a trademark, PrivateLine is a registered trademark, and Extra Care is a service mark of Epson America, Inc.

Pixelworks, DNX, and the DNX logo are trademarks of Pixelworks, Inc.

General Notice: Other product names used herein are for identification purposes only and may be trademarks of their respective owners. Epson disclaims any and all rights in those marks.

# Contents

<b>Welcome</b>	<b>6</b>
Registration and Warranty	<b>6</b>
Optional Accessories	<b>7</b>
About This Manual	<b>7</b>
Epson MovieMate 72 Parts and Controls	<b>8</b>
<b>Playing Movies</b>	<b>11</b>
Choosing a Location	<b>11</b>
Wall and Projection Screen Recommendations	<b>13</b>
Viewing on a Wall	<b>13</b>
Viewing on a Projection Screen	<b>13</b>
Adjusting the Picture	<b>15</b>
Adjusting the Sound	<b>18</b>
Controlling Playback	<b>18</b>
Pausing	<b>18</b>
Searching (Fast Forward or Reverse)	<b>19</b>
Playing in Slow Motion	<b>19</b>
Skipping	<b>19</b>
Zooming In or Out	<b>19</b>
Using DVD Menus	<b>20</b>
Temporarily Stopping Audio or Video	<b>20</b>
Adjusting the Color Mode	<b>20</b>
Adjusting the Sound and Audio Modes	<b>21</b>
Listening with Headphones	<b>22</b>

<b>Using Epson MovieMate with Other Equipment</b>	<b>23</b>
Viewing Video from External Devices	23
Connecting a USB Device	27
Using a Subwoofer	28
Playing Epson MovieMate Audio Through an External Audio System	29
Connecting a Computer or Laptop	30
<b>Doing More with Epson MovieMate</b>	<b>32</b>
Playing Music and DivX Videos and Viewing Photos	32
Playing Music CDs	32
Playing MP3/WMA Music or DivX Videos	33
Viewing JPEG Photos	34
Using Advanced Playback Controls	35
Repeating a Chapter, Title, Track, or File	35
Changing the Play Sequence (Program Play)	35
Selecting Language, Subtitles, and Camera Angles	36
Using the Playback Information Screen	37
Playing Video CDs with Playback Control (PBC)	37
Customizing Epson MovieMate	39
Locking DVDs	39
Locking the Power Button on the Control Panel	40
Saving Power	40
Changing Language Settings	41
Adjusting Picture Quality	41
Using the Others Setup Page	42
Adjusting Dolby Audio Settings	43
Setting Video Options	43
Viewing Status Information and Resetting the Lamp Timer	44

<b>Caring for Your Epson MovieMate</b>	<b>45</b>
Protecting Epson MovieMate	45
Cleaning the Lens	45
Cleaning the Case	46
Cleaning and Replacing the Air Filter	46
Replacing the Lamp	48
Resetting the Lamp Timer	50
Storing Epson MovieMate	51
Transporting Epson MovieMate	51
<b>Problem Solving</b>	<b>52</b>
What To Do When the Lights Flash	52
Solving MovieMate Operation Problems	54
Solving Picture and Sound Problems	55
Problems with External Video Equipment	58
Where To Get Help	59
Internet Support	59
Speak to a Support Representative	59
Purchase Supplies and Accessories	59
<b>Specifications</b>	<b>60</b>
<b>Index</b>	<b>66</b>

# Welcome

Your Epson MovieMate™ 72 is a portable, lightweight home cinema system that delivers high-quality, big-screen entertainment anywhere you want. In just a few minutes, you can set up MovieMate and watch a DVD, play a video game, or view your favorite photos.

Epson MovieMate offers these outstanding features:

- Flexibility to set up in any room (or even outdoors), from 2.4 feet to 44.9 feet away from a screen or wall
- DVD resolution of up to 720p
- Widescreen viewing with 16:9 aspect ratio
- Up to 1200 ANSI lumens of brightness, enough for viewing in daylight
- 1000:1 contrast ratio, for deep, vibrant images
- HDMI interface for connecting high-end video equipment.
- DVD player with Dolby® Digital and DTS
- Built-in speakers with DTS digital surround sound
- Long-life bulb providing up to 3000 hours of use
- Two-year home service warranty

---

## Registration and Warranty

Your Epson MovieMate comes with a basic two-year carry-in warranty. For details, see your *Quick Guide*.

In addition, Epson® offers free Extra Care<sup>SM</sup> Home Service during your warranty period. In the unlikely event of an equipment failure, you won't have to wait for your unit to be repaired. Instead, Epson will ship you a replacement unit anywhere in the United States or Canada, usually via overnight delivery. See your Extra Care Home Service brochure for details.

We encourage you to register your Epson MovieMate. You can register using the CD that came in the box. Or you can register online at <http://www.epson.com/webreg>. Registering also lets you receive special updates on new accessories, products, and service.

# Optional Accessories

Epson provides these replacement parts and optional accessories for the Epson MovieMate:

Product	Part number
Replacement lamp (ELPLP43)	V13H010L43
Replacement air filter (ELPAF15)	V13H134A15
Kensington® security lock	ELPSL01
Portable floor-standing and wall-mountable screens	For details on these and other optional accessories, see:
Ceiling-mountable screens	<a href="http://www.epson.com/homeentertainment">www.epson.com/homeentertainment</a>

You can purchase accessories from an Epson authorized reseller. To find the nearest reseller, call 800-GO-EPSON (800-463-7766). Or you can purchase online at [www.epsonstore.com](http://www.epsonstore.com) (U.S. sales) or [www.epson.ca](http://www.epson.ca) (Canadian sales).

## About This Manual

See the *Quick Guide* to set up your Epson MovieMate and start using it. This book contains information on using all the features of MovieMate, troubleshooting tips, and specifications.

Please follow these guidelines as you read through the manual:

**Warnings:** Must be followed carefully to avoid bodily injury.

**Cautions:** Must be observed to avoid damage to your equipment.

**Notes:** Contain important information about your equipment.

**Tips:** Contain helpful projection tips.

Need additional help? Visit Epson's [U.S. support website](#) or [Canadian support website](#) for solutions to common problems. You can download utilities and documentation, get FAQ's and troubleshooting advice, or e-mail Epson with your questions.

If you need more help, you can use the Epson PrivateLine® Support service. Call (800) 637-7661 and enter the PIN on the PrivateLine support card that came with MovieMate.

# Epson MovieMate 72 Parts and Controls

## Front View

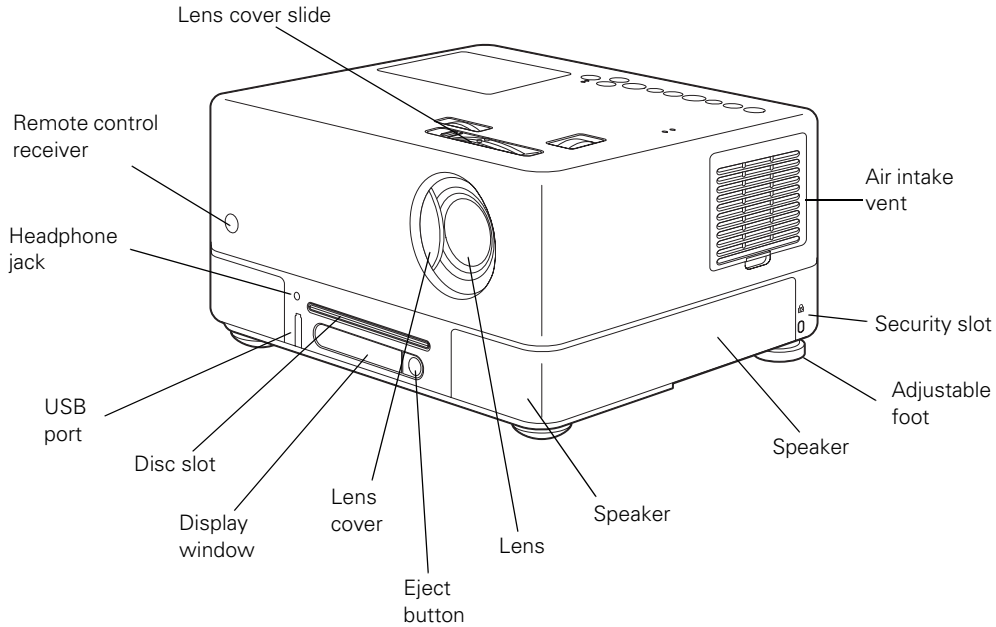

## Back View

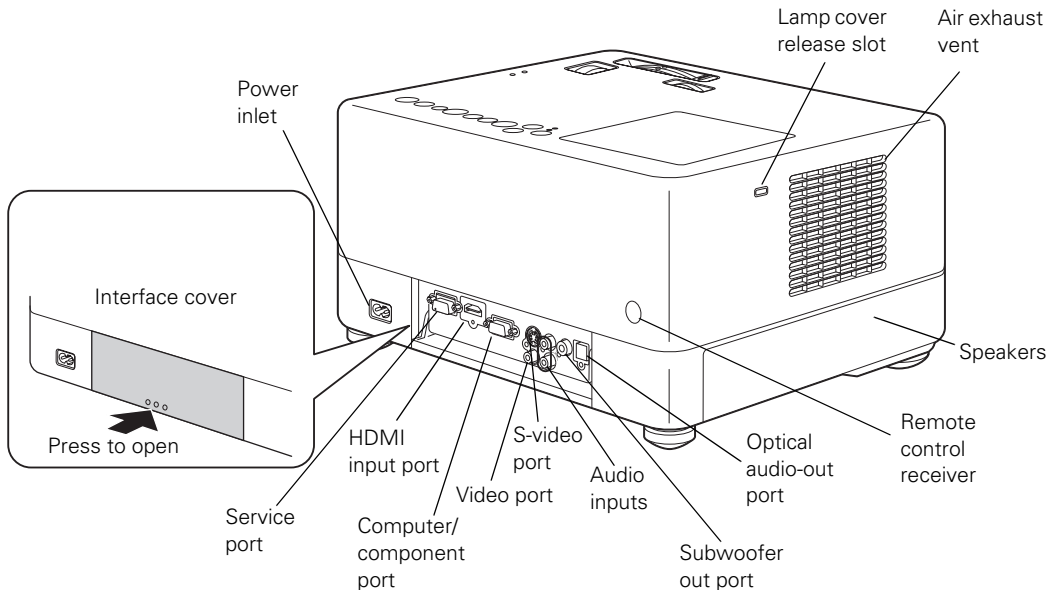



# Top View

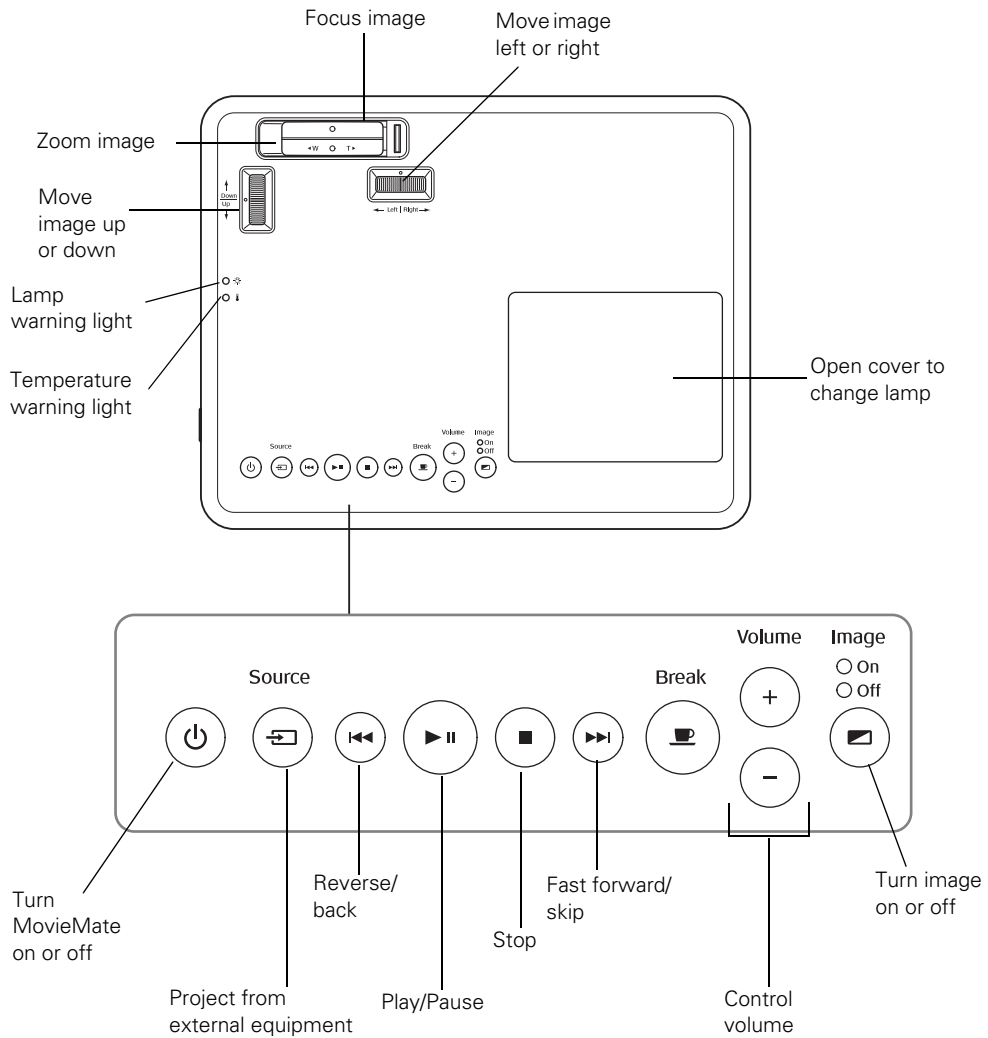

# Remote Control

**Note:** The remote control buttons glow in the dark after being exposed to light for several minutes.

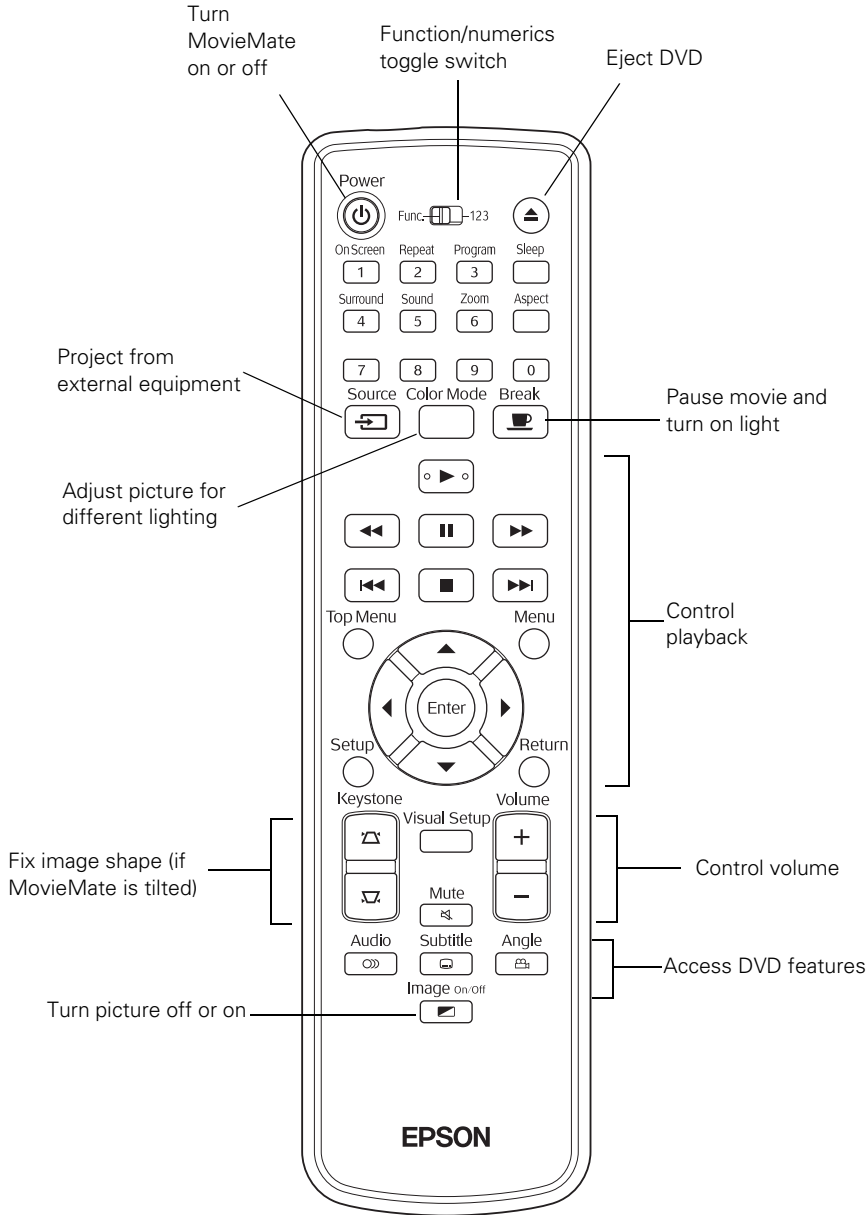

# Playing Movies

Follow the instructions in this section to choose a location, play a DVD movie, and control playback.

## Choosing a Location

You can use your Epson MovieMate just about anywhere—in the living room, bedroom, or even outside. You can use it with an optional floor-, wall-, or ceiling-mounted screen, or simply project on a flat white wall.

The following pictures show four different setups:

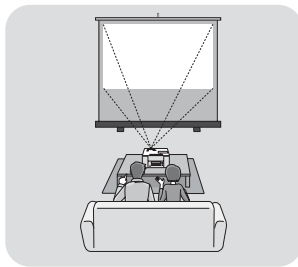

Front

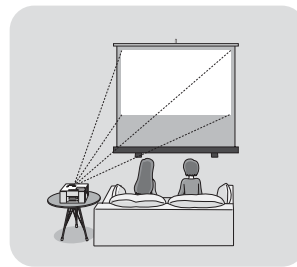

Side

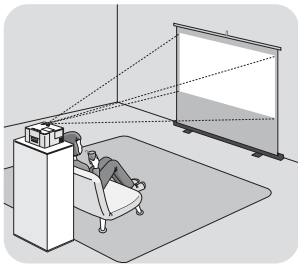

Back

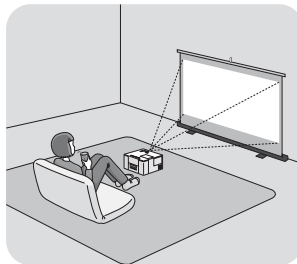

Floor

To project onto a wall, choose a flat white wall with a smooth surface. When you find a suitable wall for projection, you may want to consider coating the area with projection paint to enhance the image quality. For details, see “Wall and Projection Screen Recommendations” on page 13.

MovieMate doesn't have to be directly in front of the screen or wall, but it has to face straight ahead (at a 90-degree angle to the surface). If the image is too low, too high, or off to the side, you can use the quick image adjustment dials to adjust the position (see page 15 for instructions).

The farther you place MovieMate from the screen or wall, the larger the image will be.

The following table lists the distances required for various image sizes (measured diagonally). Note that the zoom adjustment also affects image size.

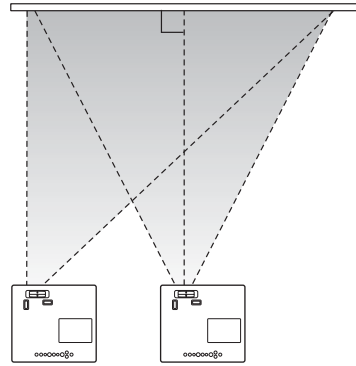

*Wide screen aspect ratio (16:9)*

Image size	Projection distance
30 in. (26 × 15 in.)	2.4 to 3.6 ft.
40 in. (35 × 20 in.)	3.2 to 4.8 ft.
60 in. (51 × 28 in.)	4.8 to 7.3 ft.
80 in. (71 × 39 in.)	6.4 to 9.7 ft.
100 in. (87 × 47 in.)	8.1 to 12.2 ft.
120 in. (106 × 59 in.)	9.7 to 14.6 ft.
150 in. (130 × 75 in.)	12.2 to 18.3 ft.

*Standard aspect ratio (4:3)*

Image size	Projection distance
30 in. (24 × 18 in.)	2.9 to 4.4 ft.
40 in. (32 × 24 in.)	3.9 to 5.9 ft.
60 in. (47 × 35 in.)	5.9 to 8.9 ft.
80 in. (63 × 47 in.)	7.9 to 11.9 ft.
100 in. (79 × 59 in.)	9.9 to 14.9 ft.
120 in. (94 × 71 in.)	11.9 to 17.9 ft.
150 in. (118 × 91 in.)	14.9 to 22.4 ft.

When setting up MovieMate, keep these considerations in mind:

- Make sure you don't block the air vents on the sides.
- Make sure you place MovieMate within 10 feet of an electrical outlet, power strip, or extension cord.
- Do not tilt MovieMate more than 15 degrees.

## Wall and Projection Screen Recommendations

To optimize viewing of MovieMate images on a wall in your home or on an optional projection screen, follow the recommendations in this section.

### ***Viewing on a Wall***

You can easily view MovieMate's high quality images on any flat white wall in your home. There is no cost or setup involved, and you can project and resize the image up to any size that fits on your wall. To enhance the image quality even further, you may want to paint the wall with projection paint that is specially designed for optimum reflectivity and contrast in your viewing environment.

### ***Viewing on a Projection Screen***

If you don't have a suitable wall in your home or want a professional quality viewing experience, you can use a projection screen. These screens have optical coatings with special reflective properties that enhance brightness, contrast, and sharpness as well as providing a frame around the image.

Projection screens are available in many shapes, sizes, mounting styles, colors, and surface qualities, as described below.

### ***Considering Screen Shape and Size***

In a home theater setting—for watching DVD movies, HDTV broadcasts, or other widescreen content—the best screen shape ratio is 16:9, where the width is almost twice the height. Most DVD movies and HDTV broadcasts will fill the screen vertically and horizontally for maximum impact. The most popular sizes are from 45 to 100 inches diagonal.

Standard screens have a 4:3 shape ratio, which is better suited for viewing computer presentations and standard TV broadcasts. Watching DVD movies or HDTV broadcasts on a 4:3 ratio screen limits the image width and leaves black bars above and below the image. Available screen sizes vary, but are usually up to 60 inches diagonal (the same height as an 80-inch diagonal 16:9 screen).

Screens are also available for wider image formats, such as CinemaScope™ (approximately 2.35:1), but are not as common.

### ***Considering Screen Mounting Style***

Most screens are either floor-standing, wall-mounted, or ceiling-mounted. Consider these characteristics as you choose which type would be best for your viewing environment:

<b>Screen mounting style</b>	<b>Characteristics</b>
Floor-standing screens	<ul style="list-style-type: none"> <li>Portable</li> <li>Can be used in multiple locations</li> <li>Can be stored out of the way</li> <li>Some may also be wall-mountable</li> </ul>
Wall-mounted screens	<ul style="list-style-type: none"> <li>Typically permanently installed</li> <li>Can be partially hidden out of the way</li> <li>Some may be disguised as artwork</li> </ul>
Ceiling-mounted screens	<ul style="list-style-type: none"> <li>Typically permanently installed</li> <li>Can be partially hidden out of the way</li> <li>Some may be recessed into the ceiling and hidden completely</li> <li>Can be manually or electronically dropped and raised</li> </ul>
Outdoor screens	<ul style="list-style-type: none"> <li>Resistant to outdoor environmental factors</li> <li>Can be used on patios, and around pools and landscaping</li> <li>Usually made of inflatable plastic or vinyl</li> </ul>

### ***Considering Color and Surface Quality***

For home theater settings, screens come in white or a shade of gray. Gray screens (sometimes called high contrast screens) increase the natural contrast of images projected in rooms with ambient light by absorbing the room light and preserving the darker blacks. If you have a dedicated home theater room with dark walls, ceiling, floor, and furniture, a gray screen may not provide better contrast than a white screen. However, if you usually project images in a typical living room or family room with some reflected light, a gray screen will provide better contrast and a truer viewing experience.

Screen surface quality can also affect the reflectivity of light in your projected image. Screen reflective properties are measured as “gain” rates, with 1.0 gain as the reflectivity of a white board. Highly reflective screen surfaces (above 1.0 gain) create a brighter image, but the brightness may not be uniform enough for a dedicated home theater environment and the colors may appear to shift from different viewing angles.

In a home theater room with darkened surroundings and controlled lighting, a screen surface with less than 1.0 gain is best. For rooms where you cannot control the light or will always have ambient light, you may want to select a screen surface with more than 1.0 gain to compensate for the additional brightness.

## Adjusting the Picture

After you set up your Epson MovieMate and start your movie, you may need to make certain adjustments.

- If the image is too low, too high, or off to the side, use the quick image adjustment dials to adjust its position.

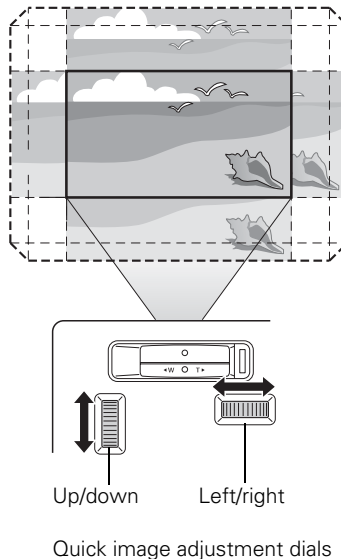

**Note:** The image adjustment feature cannot move the image both horizontally and vertically by the full amount. For example, if you have moved the image all the way up, then you cannot shift it all the way to the right or left at the same time.

- Rotate the zoom ring to reduce or enlarge the picture.

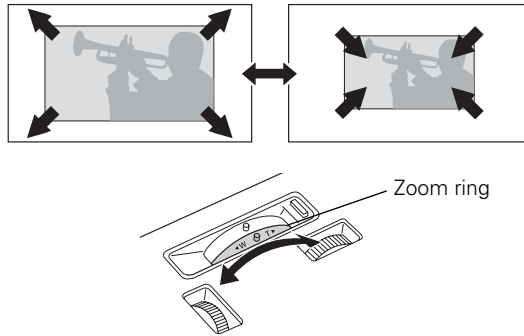

- If the picture is still not high enough, you can extend the feet and tilt MovieMate up.

If MovieMate is rotated so that the lens faces away from the disc slot, you can adjust the feet as shown:

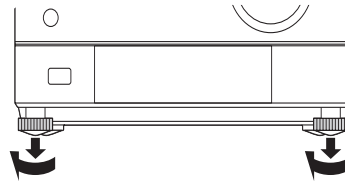
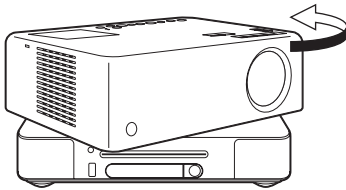
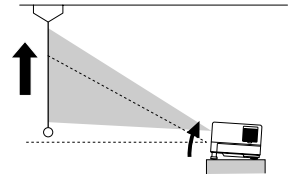

If you're using MovieMate without rotating the top section and you need to tilt it up, you can use the riser.

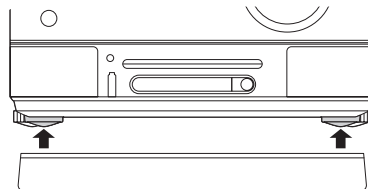



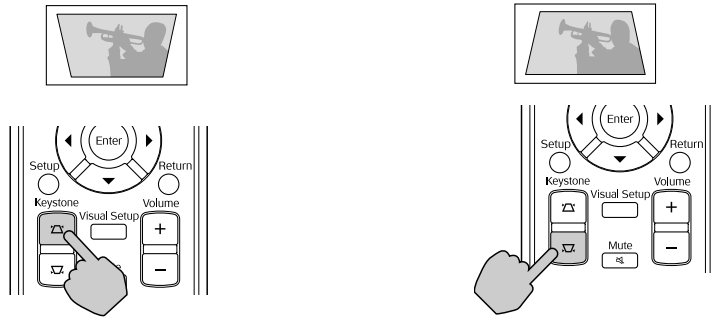

If you tilt MovieMate, the image will lose its rectangular shape. Use the **Keystone** buttons on the remote control to adjust the image shape.

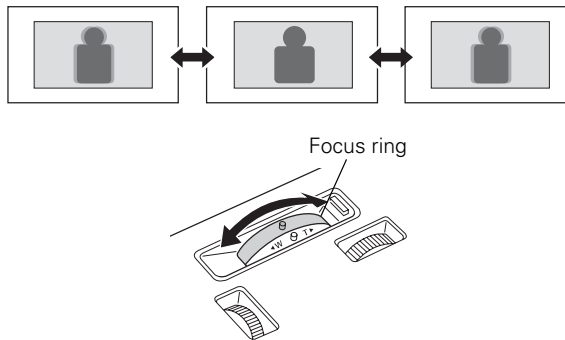

- Rotate the focus ring to sharpen the picture.



- To enlarge or reduce the aspect ratio of the picture, press the <sup>Aspect</sup>  button on the remote control to select **Normal**, **Full**, or **Zoom** (if available for the video source you're using). (Make sure the toggle switch on the remote control is set to the **Func.-** position.)

# Adjusting the Sound

To adjust the volume, use the + or – Volume buttons on the control panel or remote control.

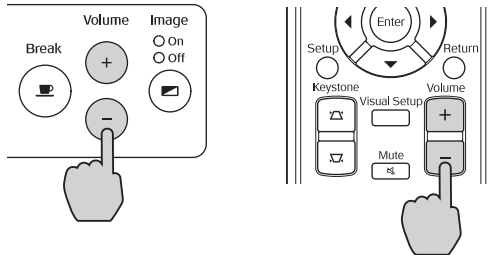

You can also press the  button on the remote control to temporarily turn off the sound.



# Controlling Playback



You can use the buttons on the remote control or the MovieMate control panel to pause, fast-forward, or replay sections of your video or audio. You can also select items on a DVD menu by using the remote control.

**Note:** DVD movies are divided into units called titles. Each title may contain any number of chapters. Music CDs and video CDs are divided into tracks.



## Pausing

There are three ways to pause a movie or audio track with MovieMate:

- To pause a movie, or a music CD or MP3 player track, press  on the remote control or  on the control panel.





To resume, press  on the remote control, or  on the control panel.

- To pause a movie and display the Epson logo, press  on the remote control or control panel.

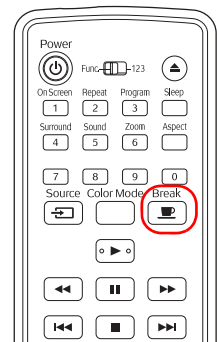
To resume, press  on the remote control, or  on the control panel.



- To pause a movie and light up the screen or wall temporarily (so you can see better in a dim or dark room), press  on the remote control or control panel.



To resume, press  again. Pressing any of the following buttons also cancels break mode: , , , or .

**Note:** After 5 minutes in break mode, the lamp turns off and the screen darkens. After 30 minutes, the power shuts off, and you need to press the  button to turn it on again.

## Searching (Fast Forward or Reverse)

- To move forward or backward through a video or music CD, press  or  on the remote control.

You can also press and hold  or  on the control panel.



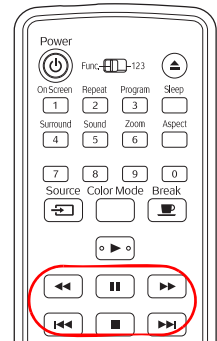

Each time you press the button, the search (or “shuttle”) speed increases.

- To return to normal play, press .





## Playing in Slow Motion







You can play a video frame by frame or in slow motion (“jog control”).

1. Press  on the remote control.
2. Press  repeatedly to advance the video frame by frame.
3. Press  or  to move forward or backward in slow motion. Each time you press the button, the speed decreases.
4. Press  to return to normal play.

## Skipping







- To skip to the next chapter or track, press  on the remote control or control panel.
- To return to the start of the current chapter or track, press  on the remote control or control panel.

## Zooming In or Out







- Press  to zoom in the image.
- Continue pressing  to zoom in or out. Use the , , , and  buttons to pan around the image if necessary.

## Using DVD Menus

Many DVDs display a top menu at startup and include submenus that let you select chapters.



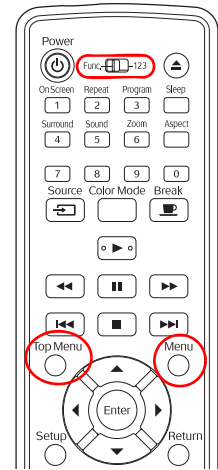

- To display a menu, press <sup>Top Menu</sup>  or <sup>Menu</sup> .
- To select items in a menu, press , , , or . Then press  if necessary.

You can also select a title or chapter by number.

- If you want to use the numeric buttons, you need to set the toggle switch on the remote control to the -123 position.
- After you set the toggle switch, you can simply press the numeric button for the numbers 1 through 9.
- To enter the number 10, press , then .
- To enter the number 15, press , then .
- To enter the number 20, press , then .
- After entering your number, you may need to press the  button.





## Temporarily Stopping Audio or Video

- To temporarily stop the soundtrack (from the built-in speakers or headphones), press . The video continues to play.  
Press  again to resume.
- To temporarily stop the picture (turn off the lamp and darken the screen), press . The soundtrack continues to play.  
Press  again to resume.

## Adjusting the Color Mode

You can select a color mode to optimize picture quality based on the lighting conditions in the room.

1. Press . The currently selected color mode is displayed on the screen.
2. Press  repeatedly until the desired color mode appears. After a few seconds, the color mode name disappears and the picture quality changes.





You can select from the following color modes:

- **Dynamic:** Use in rooms with bright light.

- **Living Room:** Use in rooms with the blinds or drapes closed.
- **Theatre:** Use in rooms with the blinds or drapes closed and the lights off; the Epson cinema filter automatically provides more natural skin tones.
- **Theatre Black:** Use in completely darkened rooms; the Epson cinema filter automatically provides more natural skin tones.
- **Game:** Use for playing games with high-speed movement in a bright room.

## ***Adjusting the Sound and Audio Modes***

You can switch between stereo sound and virtual surround sound and select from several audio modes, depending on the type of movie (or music) you're playing.

1. To display the sound mode, press the  button on the remote control. You see the current setting displayed on the screen.
2. To switch between **Stereo** and **Dolby VS** (Dolby virtual speaker mode), press  again.
3. To change the audio mode, press . You see the current setting displayed on the screen.
4. Continue pressing  to select the mode you want: **Concert**, **Drama**, **Action**, or **Sci-Fi**.

For audio CDs, the modes are: **Classic**, **Jazz**, **Rock**, and **Digital**.

# Listening with Headphones

Connect headphones as shown below:

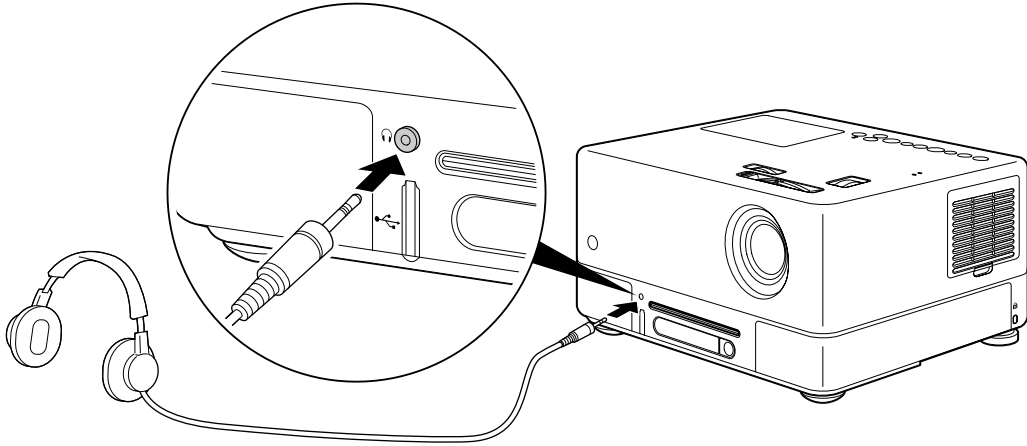

After you connect headphones, you no longer hear any sound from the built-in speakers. However, you can still adjust the volume to the headphones using MovieMate's volume controls on the control panel or remote control.

**Warning:** Make sure the volume is not set too high, especially when you first plug in the headphones. Listening to high volume sounds over an extended period can damage your hearing. Sudden high volume can also damage your headphones.

# Using Epson MovieMate with Other Equipment

You can connect a variety of video, audio, and computer equipment to MovieMate to further enhance your viewing and listening experience.

- Video equipment such as a TV, VCR, DVR, cable or satellite TV receiver, game console, video camera, digital camera, video or photo iPod, or other device that has a video output port
- A USB flash drive containing photos, music files, or DivX® videos
- Optional subwoofer for rich, powerful bass tones
- Audio input equipment such as an iPod or other MP3 player to play music through MovieMate
- Audio output equipment such as an AV amplifier or 5.1 Stereo Surround Sound System to play audio from MovieMate
- Computer or laptop to project anything you can see or hear on your computer through MovieMate.

---

## Viewing Video from External Devices

You can connect to external video devices that have composite video, S-Video, HDMI, or component video ports. To play audio from these sources, you also need to connect standard white and red audio jacks to MovieMate's L and R Audio inputs. (For HDMI equipment the audio is carried through the HDMI cable.)

**Note:** If your device has both composite and S-Video ports, use S-Video for higher quality.

When you view video from an external source, you can use most of MovieMate's controls, including adjusting color mode, volume, and sound mode.

You will need connection cables, which may be included with your external equipment, or may be purchased from an electronics store.

**Caution:** Before connecting, make sure all equipment is turned off.

Connect the external equipment as shown on the following pages.

### Composite Video Connection

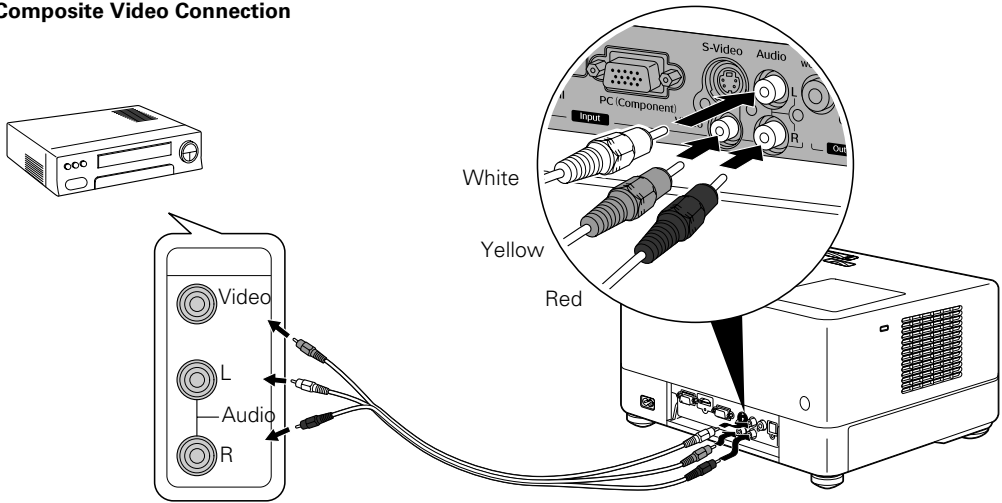

For connecting a TV, VCR, or DVD player, cable or satellite TV receiver or DVR, game console, camcorder, video or photo iPod, or digital camera.

### S-Video Connection

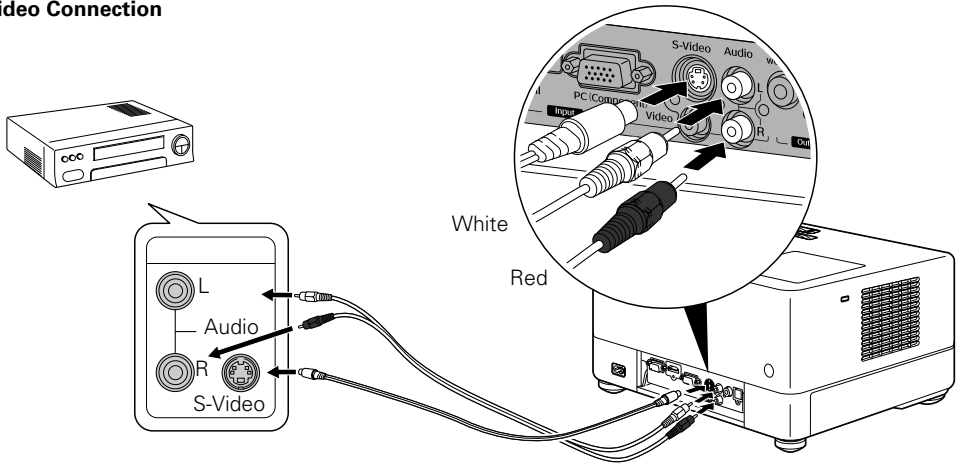

For connecting a VCR, DVD player, or camcorder.



## Component Video Connection

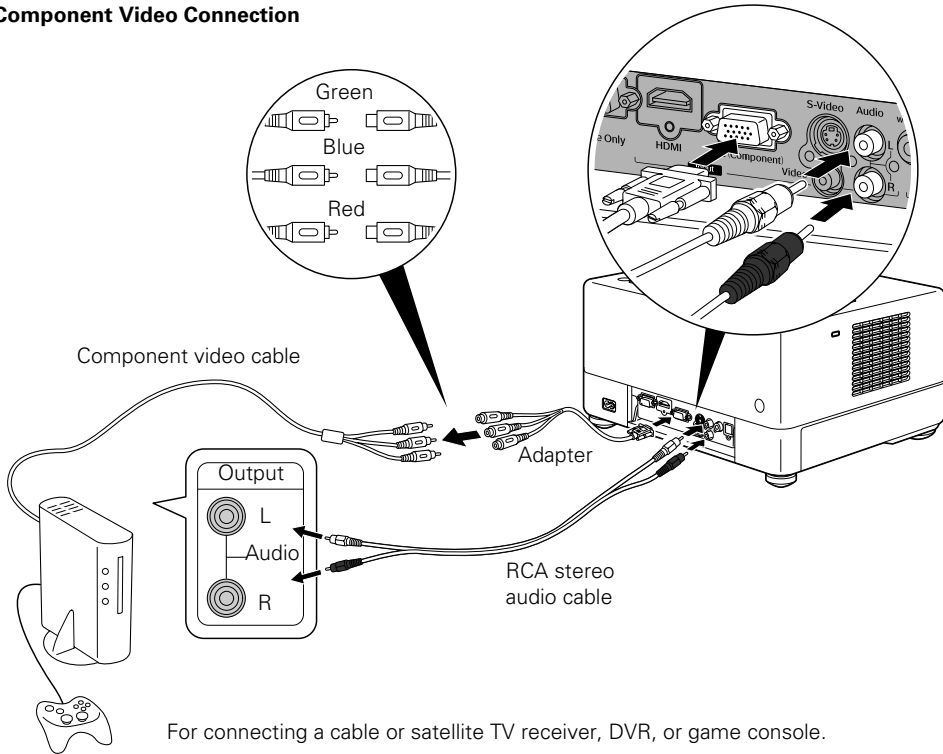



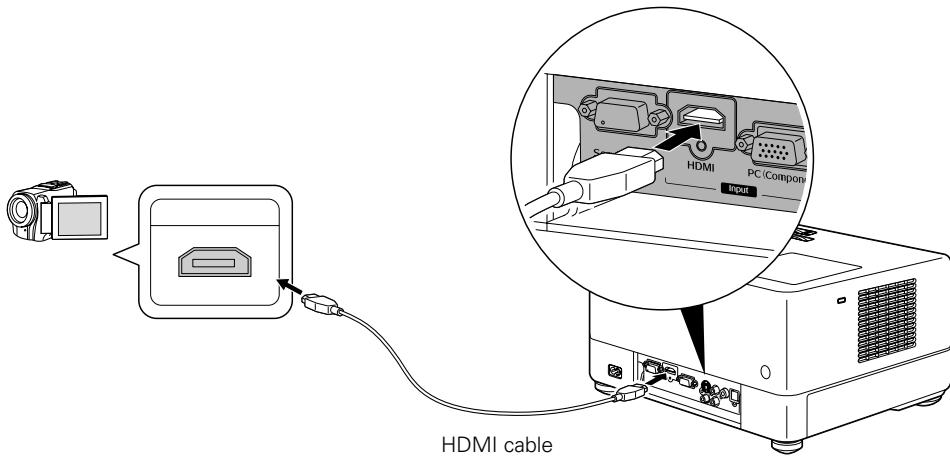

## HDMI Video Connection



For connecting an HD cable or satellite TV receiver, HD DVR, or HD camcorder.

After you connect your equipment to MovieMate, follow these steps to begin:

1. Connect the power cords and plug in all the equipment.
2. Open the lens cover and press the  button on MovieMate or on the remote control.
3. Press the  button on MovieMate or on the remote control.
4. When you see the menu, use the down-arrow or up-arrow button to select the correct source, then press .
  - If you used the HDMI connection, select **HDMI**.
  - Otherwise, select **Video**.
5. Turn on the power to the connected video equipment, then start playing the video or game.
6. Normally, MovieMate selects the correct aspect ratio automatically. If you need to change the aspect, press the  button on the remote control and select **Normal**, **Full**, or **Zoom** (if available for the video source you're using). (Make sure the toggle switch on the remote control is set to the **Func.-** position.)

## Connecting a USB Device

You can connect a USB device, such as a flash drive or memory card reader containing a memory card. You can view photos or play music or DivX videos. MovieMate supports the following types of files on USB devices:

- MP3
- WMA
- JPEG
- DivX

Connect the drive or other device to the USB port as shown below. Playback starts automatically. **When you're finished, make sure you press  before removing the device from the USB slot.**

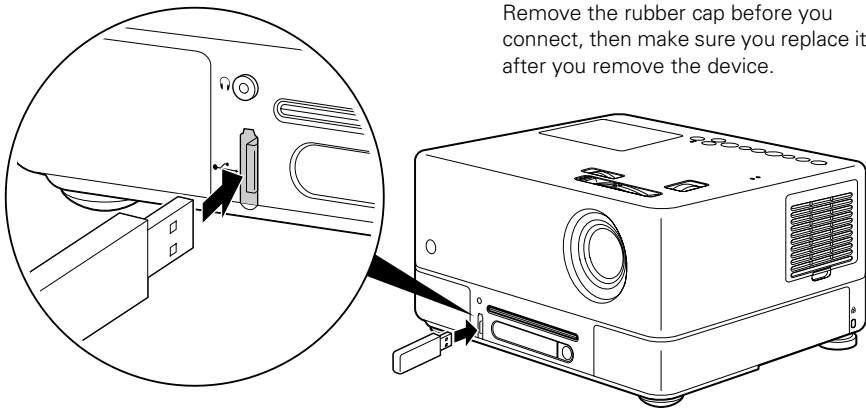

For instructions on playing MP3, WMA, JPEG, or DivX files, see page 32.

# Using a Subwoofer

You can connect a subwoofer to provide rich, deep bass sound for your movies, games, and other presentations with audio.

1. Connect the subwoofer using an RCA audio cable as shown below. See the instructions included with the subwoofer for more information.

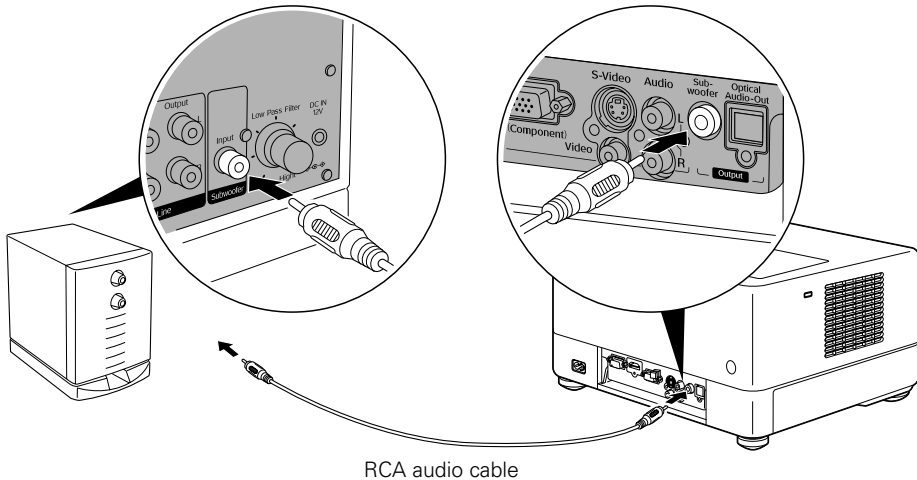

2. Plug in and turn on the subwoofer.
3. Turn the speaker side of the subwoofer toward your listeners for the best sound.
4. Play your movie, game, or other presentation.
5. See the instructions included with the subwoofer for more information. You can adjust the volume using MovieMate's control panel or remote control, and use any of MovieMate's other audio controls, as described on pages 18 and 21.

# Playing Epson MovieMate Audio Through an External Audio System

You can connect MovieMate to an audio receiver, amplifier, 5.1 Stereo Surround Sound System, or digital audio recorder. To output sound from MovieMate, the external equipment needs to have an optical audio input port.

You will also need an optical digital cable, which may be provided with your external equipment, or may be purchased from an electronics store.

1. Make sure the equipment is turned off, then connect the cable as shown:

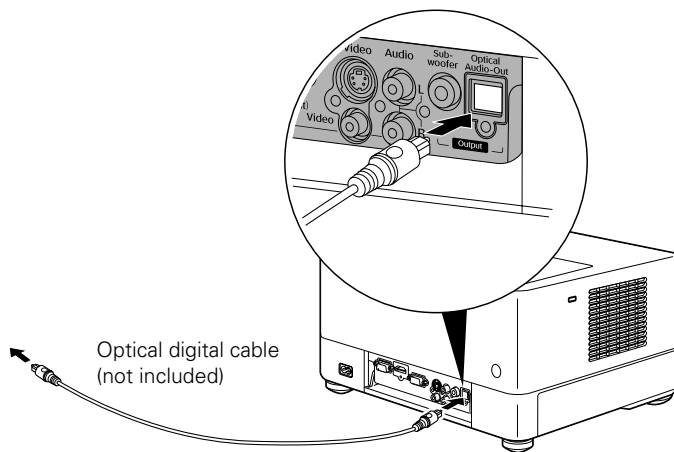

2. Turn on your audio equipment and play your movie, music, or other presentation with sound from MovieMate.
3. You may need to change the **Digital Output** setting in the Audio Setup Page. Select **All** if you are connecting a DTS/Dolby Digital Decoder or **PCM only** if you are connecting to equipment that is only compliant with linear PCM. For more information, see page 43.

You can also use any of MovieMate's audio controls, as described on pages 18 and 21.

# Connecting a Computer or Laptop



You can connect MovieMate to a computer or laptop to play videos or games, display presentations or photos, or project anything you can see and hear on your computer.

You will need a computer cable (D-sub 15-pin to D-sub 15-pin) and an RCA stereo audio cable (2-RCA to stereo mini-pin, no resistance). You can purchase these cables from an electronics store.

**Caution:** Before connecting, make sure all equipment is turned off.

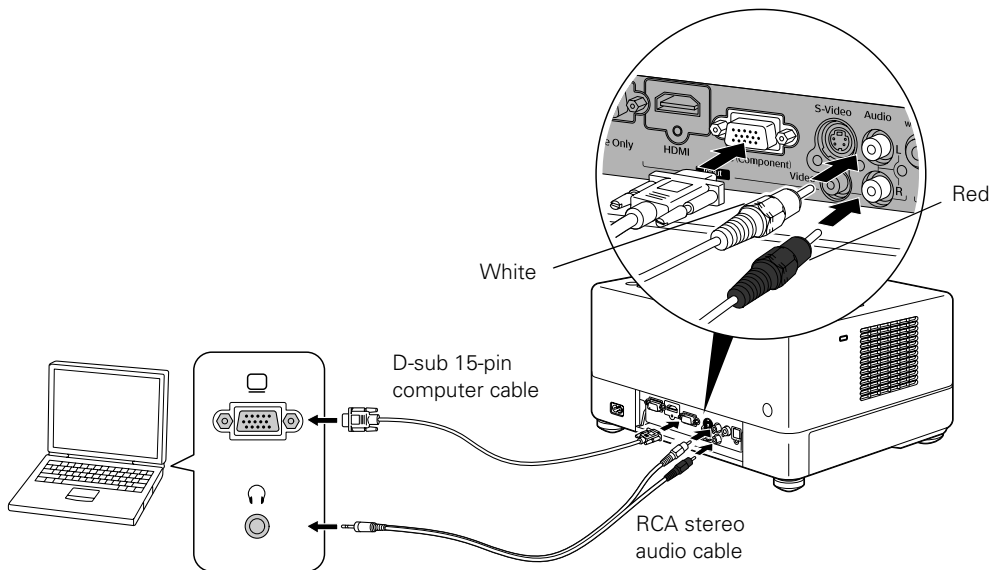
1. Connect the computer or laptop as shown.



2. Connect the power cords and plug in all the equipment.
3. Open the lens cover and press the  button on MovieMate or on the remote control.
4. Press the  button on MovieMate or on the remote control.
5. When you see the menu, use the down-arrow or up-arrow button to select **PC**, then press .
6. Turn on the power to the connected computer or laptop.
7. Switch the display on the computer or laptop to display on MovieMate, or on both MovieMate and the computer screen. Usually you do this by pressing function keys to toggle through display choices; see your computer documentation for instructions.

**Note:** If your laptop cannot play movies on both the laptop display and an external display, you may need to disable the laptop display to view movies on MovieMate. See your laptop documentation for instructions.

8. Normally, MovieMate selects the correct aspect ratio automatically. If you need to change the aspect, press the  button on the remote control and select **Normal**, **Full**, or **Zoom** (if available). Make sure the toggle switch on the remote control is set to the **Func.-** position.

# Doing More with Epson MovieMate

Follow the instructions in this section to play music and photos on your Epson MovieMate, use advanced playback controls, and adjust various MovieMate features.



## Playing Music and DivX Videos and Viewing Photos

You can play music CDs and CDs or USB devices with MP3, WMA, and DivX files. You can also view JPEG photos on CDs or USB devices.

### Playing Music CDs

- To play a music CD, simply insert it in the slot.

You can use most of the playback features, including pause, resume, fast forward, reverse, and skip to the next or previous track. See page 18 for instructions.

- You can also select a specific track by using the numeric buttons, as described on page 20. To use the numeric buttons, you need to set the toggle switch on the remote control to the -123 position.
- To turn on the lamp when playing music, press . Press  to turn the lamp off.

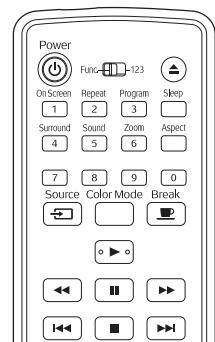

**Note:** When you play music CDs, the lamp usually turns off automatically.







## Playing MP3/WMA Music or DivX Videos



You can play MP3 or WMA music files and DivX videos on CDs, DVDs, or USB devices. See page 64 for information on the types of discs that are supported.

When you insert a disc or USB device that contains MP3, WMA, and/or DivX files, you see a list of files and/or folders:





1. Press  or  to select a folder or file.

To go to the next or previous page, press  or .

2. Press  or  to begin playing the selected track or file.

When a file is finished playing, the next file in the sequence will start automatically.

- To turn off the lamp when playing music files, press .

To turn the lamp back on, press  again.

- When you play MP3 or WMA files, scrolling through the list of songs will pause the music until you highlight the next file.



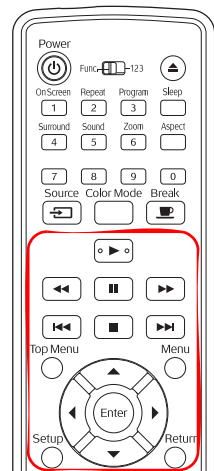



**Note:** You can use the Setup menu to change the way files are displayed. See page 42 for instructions.









## Viewing JPEG Photos

When you insert a disc or USB device that contains JPEG photo files, you see your photos displayed in a slideshow.

If your photos are saved in folders, you see a list of files and/or folders (maximum 298 folders and 648 photos).

- Press  or  to select a folder or file, then press  to begin displaying the photos.
- To rotate an image, press  or .
- To stop the slideshow and display a thumbnail screen, press .





- To display the next or previous page of thumbnails, press  or .
- To display the list of the files and folders, press .
- If your disc or USB device includes both music files and JPEG photos, you can play a slideshow with music.
  1. To display the list of files, press .
  2. Select the music file you want and press  to start playing it.
  3. Select the JPEG file you want and press  to start displaying the slideshow.

# Using Advanced Playback Controls

MovieMate provides advanced features for looping videos or music tracks and selecting titles, chapters, or tracks. On DVDs that include subtitles, multiple languages, or multiple camera angles, you can use the remote control for easy access to these features.

## Repeating a Chapter, Title, Track, or File

You can select a chapter or title on a DVD to repeat continuously (or loop). You can also repeat a track on a music CD or an MP3, WMA, JPEG, or DivX file.

1. To repeat a chapter, title, or track, press . You see an icon on the screen indicating the selected repeat option.
2. Press  again to cycle through the options for repeating.
  - On a video DVD, you can repeat a chapter or title or select random play (Shuffle).
  - On an audio or video CD, you can repeat one track or all tracks or select random play (Shuffle).
  - For MP3, WMA, JPEG, and DivX files, you can repeat a file, all files in a folder on on a disc, or select random play (Shuffle).
3. To cancel repeat play, press  until Repeat Off is displayed on the screen.

## Changing the Play Sequence (Program Play)





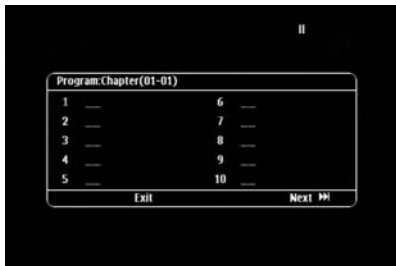



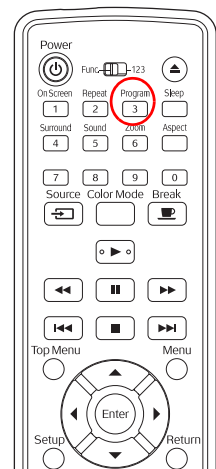



You can create your own program for playing tracks on a music CD or chapters and titles on a DVD. Programs are saved for up to 10 discs, even after you change the CD or DVD.

1. Press . You see the program screen, which allows you to set a playback sequence:





2. Set the toggle switch on the remote control to the -123 position.



3. Use the numeric buttons to set the program order (up to 99 chapters, titles, or tracks).
  - Press , , , or  to move the cursor.
  - If a disc has more than 10 chapters or tracks, press  or  to display the next or previous page. Or, select **Next** or **Previous** on the screen and press .
  - To delete a track or chapter you have entered, select it and press .
  - To close the program screen, select **Exit** on the screen and press .
4. To begin playing your programmed sequence, select **Start** on the screen and press .
5. Set the toggle switch on the remote control back to the **Func.-** position.
6. To cancel the program, press .
7. To resume normal playback, stop play and press .

## ***Selecting Language, Subtitles, and Camera Angles***

Some DVDs and DivX files allow you to display subtitles or select from several languages or camera angles. If these features are available, you can use the buttons on the remote control to select them.

1. Press the appropriate button on the remote control:
  - To change the language of the video, press  <sup>Audio</sup>.
  - To display subtitles, press  <sup>Subtitle</sup>. You may have a choice of subtitle languages or subtitle files (for DivX videos).
  - To change camera angles, press  <sup>Angle</sup>.
2. Press the button repeatedly to select the option you want.





**Note:** You can also use the Playback information screen, as described on page 37. For a list of language codes, see page 65.

## Using the Playback Information Screen

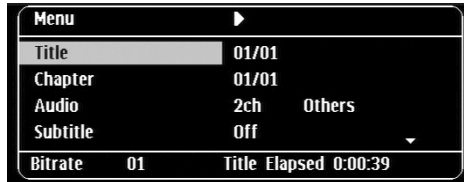
You can check the current playback status and change settings while you are playing a DVD, audio or video CD, or DivX video.

1. Press <sup>OnScreen</sup> . You see an information screen like the following below the projected image:



2. Press , or  to select the item you want to set and press .
3. Select the setting you want and press .

You can set the title, chapter, track number, or start time using the numeric keys, as described on page 20. To use the numeric buttons, you need to set the toggle switch on the remote control to the -123 position.





After you press , playback starts from the title, chapter, track, or time you selected.

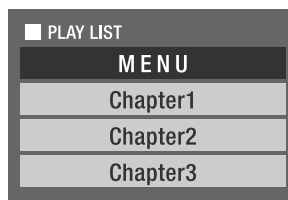

## Playing Video CDs with Playback Control (PBC)

When you insert a video CD with playback control (PBC), you see a menu like the following:





- To select the item you want to play, press , or  or set the toggle switch on the remote control to the -123 position, then use the numeric buttons as described on page 20.
- To display the next or previous menu page, press  or  when the menu is displayed.
- To open the menu during playback, press <sup>Return</sup>  repeatedly until the menu you want is displayed.

To use the Preview function, follow these steps:

1. Press  to display the preview menu:





2. Press , or  and press  to select one of the following (each displays 6 images or tracks on a single screen page):

**Track Digest:** Plays the first 3 or 4 seconds of each track sequentially.

**Disc Interval:** Divides the total disc time by 6 and plays the first 3 or 4 seconds of each interval.

**Track Interval:** Divides each track into 6 intervals and plays the first 3 or 4 seconds of each interval.



- To return to the initial menu, select **Menu** and press .
  - To close the preview menu, select **Exit** and press .
3. Select the track you want to see using the arrow buttons and press .

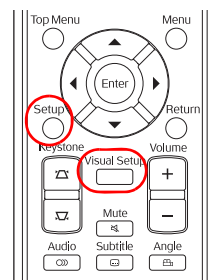

# Customizing Epson MovieMate

You can limit children's access, adjust the sound, and customize other features of MovieMate. Many of these settings are available by pressing the Setup or Visual Setup buttons on the remote control.









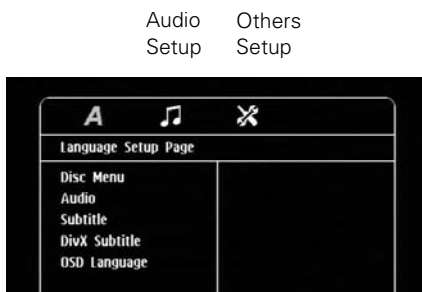

## Locking DVDs

You can lock up to 40 DVDs to prevent children from viewing them. When a disc is locked, you need to enter a password before you can play it.

1. Insert the DVD you want to lock. Press  twice to stop the video.
2. Press the  button on the remote control. You see the Language Setup Page:





3. Press  until you see the Others Setup Page.
4. Press  to highlight Disc Lock, then press  to change the setting.
5. Press  to select Lock, then press .
6. Press  to highlight Password, then press  to change it.
7. Press  to select New Password.
8. Set the toggle switch on the remote control to the -123 position, then enter 6 digits using the numeric buttons. The first time you set a password, you need to enter enter 000000 in the Old Password column first, then enter the new password.
9. Enter the same digits again for Confirm PWD using the numeric buttons.
10. Press  to save your password.

Once a password is set, you will need to enter it before you can view the locked CD or DVD. If you forget your password, enter 000000 in the Old Password column to reset the password.

11. Press  to exit the menu.







## Locking the Power Button on the Control Panel

You can lock the  button on the control panel to prevent young children from accidentally turning on MovieMate and looking into the lens. (You can still turn on MovieMate using the remote control, so you may want to place it out of children's reach. You will also be able to turn on MovieMate by holding down the  button on the control panel for at least 5 seconds.

**Warning:** Do not allow young children or pets to look into the projector lens when MovieMate is turned on. The lens projects bright light that may affect their vision.

1. Press  on the remote control. You see the Visual Setup menu:



2. Press  to highlight Option, then press  to select it.
3. Press  until you see Child Lock.
4. Press  or  to select On, then press .
5. Press  to exit the menu.

You need to restart MovieMate for the setting to take effect.

## Saving Power

The power turns off automatically when a DVD is stopped for more than 30 minutes. You can select a time to turn off MovieMate while a movie is playing, in case you fall asleep while watching.

To select a sleep setting, press . Continue pressing the button to select from the following settings:

- **SLEEP OFF:** The power switches off automatically after 30 minutes of inactivity (default setting).
- **SLEEP 10, 20, 30, 60, 90, 120, 150:** The power switches off automatically after the number of minutes specified, whether or not a movie is playing. You can select from 10 to 150 minutes.

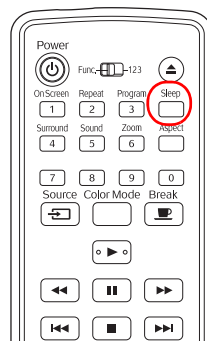



After you set the sleep timer, you can see the time remaining by pressing .



**Note:** Sleep timer settings are not saved after you turn MovieMate off.

## Changing Language Settings

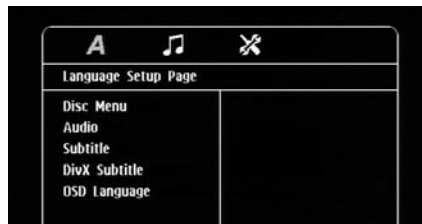

You can use the Language Setup Page to change the default language for DVDs that allow you to make this selection.

1. Press the  button on the remote control. You see the Language Setup Page:





2. Press  to highlight the setting you want, then press  to display the list of languages available.

OSD Language is the language used for MovieMate's menus. Other settings may not be available, depending on the DVD or DivX file you are playing.

3. Press  to select the language you want, then press  to save it. For a list of language codes, see page 65.
4. To exit the menu, press .



## Adjusting Picture Quality

You can use the Image page on the Visual Setup menu to adjust the brightness, contrast, color saturation, tint, sharpness, and other settings that affect image quality.

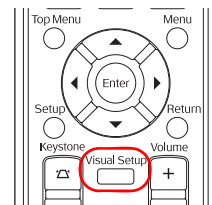
1. Press  on the remote control. You see the Visual Setup menu.
2. Press  to select Image.
3. Press  until you see the option you want to set.











You can adjust the following items for various viewing conditions and individual videos:

- **Brightness**
  - **Contrast**
  - **Color Saturation**
  - **Tint** (only works on NTSC signals)
  - **Sharpness**
  - **Progressive** (Leave this set on **Film/Auto** for most videos; switch to **Video** for camcorder output or **Off** if the picture appears jittery when you use certain external equipment. This setting is not available for some external equipment.)
4. Press  or  to increase or decrease the setting.
  5. Press  to exit the menu.

## Using the Others Setup Page







The Others Setup Page lets you select various settings, including screensaver, Video CD options, and MP3/WMA/JPEG file navigation. You can also display your code for DivX video on demand services and return all settings to their defaults.

1. Press  on the remote control.
2. Press  to display the Others Setup Page.
3. Press  to highlight the setting you want, then press  to view or change the option.
4. Press  to select the option you want, then press  to save it. You can choose from the following:
  - **Screen Saver:** By default, the screen saver starts when a still image is projected for more than 15 minutes. Select **Off** to turn off this setting.
  - **PBC:** Select **Off** to turn off playback control when you play Video CDs.
  - **Display Dim:** You can change the display window from 100% brightness to 70% or 40%.
  - **DivX VOD code:** Select this setting to display your video on demand registration code. This code allows you to purchase or rent videos through DivX video on demand services at [www.divx.com/vod](http://www.divx.com/vod) (and play them on MovieMate).
  - **MP3/JPEG Nav:** When you insert a disc or USB device that has MP3, WMA, JPEG, or DivX files, you normally see a menu showing the file and folder names. Select **Without Menu** if you don't want to see the menu (the audio or slideshow will start automatically).

- **Default:** Press  and press  to return all settings to their factory defaults (except for the Disc Lock password and lamp hours).
  - **Password:** See page 39 for instructions on setting a password for locking DVDs.
  - **Disc Lock:** See page 39 for instructions on setting a password for locking DVDs.
5. To exit the Setup menu, press .

## Adjusting Dolby Audio Settings



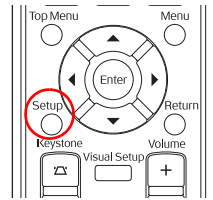

You can adjust settings for external equipment with a DTS/Dolby Digital Decoder or DVDs recorded in Dolby Digital.

1. Press the  button on the remote control. You see the **Language Setup Page**:
2. Press  to display the **Audio Setup Page**.
3. Press  to highlight **Digital Output** or **Night Mode**, then press  to select it. You can select the following settings:
  - **Digital Output:** Change to **All** if you have connected a DTS/Dolby Digital Decoder to the Audio-Out port.
  - **Night Mode:** Turn this setting on if you are watching a Dolby Digital DVD at low volume.
4. Press  to select the setting you want to change, then press  to save it.
5. To exit the menu, press .







## Setting Video Options

You can use the Visual Setup menu to adjust the signal format for external video equipment and set other video options.





1. Press  on the remote control. You see the Visual Setup menu.
2. Press  to highlight **Option**, then press  to select it.
3. Press  until you see the option you want to set.

You can adjust the following items:

- **Video Signal:** Normally, you can leave this set to **Auto** when using external equipment. If no image appears or you see interference, select the appropriate signal.
  - **Child Lock:** Turn this setting on to lock the  button on the control panel. See page 40 for more information.
  - **High Altitude Mode:** Turn this setting on if you use MovieMate at an altitude above 4,900 feet (1,500 meters), to ensure that MovieMate does not overheat.
4. Press  or  to adjust the setting.
  5. Press  to exit the menu.

## ***Viewing Status Information and Resetting the Lamp Timer***

You can use the Info page on the Visual Setup menu to view the number of hours the lamp has been used, and to reset the timer after you install a new lamp. You can also view video signal information and error codes for any problems that occur.

1. Press  on the remote control. You see the Visual Setup menu.
  2. Press  to highlight **Info**, then press  to display the lamp usage and other information.
- Note:** If the lamp has been used less than 11 hours, 0H is displayed.
3. To reset the lamp timer after replacing the lamp, press .
  4. Press  to exit.

# Caring for Your Epson MovieMate

The Epson MovieMate needs little maintenance. All you need to do on a regular basis is keep the lens clean. You also need to clean the air filter periodically to prevent overheating.

**Warning:** Before you clean any part of MovieMate, turn it off and unplug the power cord. Never open any part of MovieMate, except as described in this *User's Guide*. Dangerous electrical voltages in the projector can injure you severely. Do not try to service this product yourself, except as specifically explained in this *User's Guide*.

The only parts you should replace are the lamp and air filter. If another part needs replacing, contact Epson or a qualified servicer (see page 59).

Follow the instructions in this section to clean the lens and case, clean and replace the air filter, replace the lamp, and store or transport MovieMate.

---

## Protecting Epson MovieMate

The Epson MovieMate is designed for use virtually anywhere at home. However, MovieMate and its accessories should not be exposed to water, smoke, direct heat or sunlight, or left outside for long periods of time. As with typical electronic equipment, please avoid exposure of MovieMate to moisture, dust, smoke, and other environmental factors which may result in damage to internal electronics over time. See the warranty in the *Quick Guide* for additional details on the use of your Epson MovieMate.

---

## Cleaning the Lens

Clean the lens whenever you notice dirt or dust on the surface.

- Use a canister of compressed air to remove dust.
- To remove dirt or smears, use lens-cleaning paper. If necessary, moisten a soft cloth with lens cleaner and gently wipe the lens surface.

**Caution:** Never rub the lens with abrasive materials.

## Cleaning the Case

Before you clean the case, turn off MovieMate and unplug the power cord.

- To remove dirt or dust, wipe the case with a soft, dry, lint-free cloth.
- To remove stubborn dirt or stains, moisten a soft cloth with water and a neutral detergent. Wring the cloth as dry as possible, then wipe the case.

**Caution:** Never use wax, alcohol, benzene, thinner, or other chemical detergents. These can damage the case. Never spray cleaners directly on MovieMate.

## Cleaning and Replacing the Air Filter

Clean the air filter and air intake vent when dust builds up or when you see the following message:

The projector is overheating. Make sure nothing is blocking the air vents, and clean or replace the air filter.

If the air filter is not cleaned periodically, it can become clogged with dust, preventing proper ventilation. This can cause overheating and damage MovieMate.

1. Press the  button to turn MovieMate off and disconnect the power cable.
2. Use a small vacuum cleaner designed for computers and other office equipment to clean the filter, as shown.

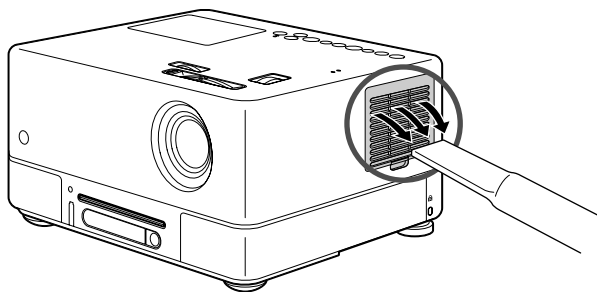

If you cannot clean the removable filter or it is broken, you need to replace it.

You can purchase a new filter (part V13H134A15) from an Epson authorized reseller. To find the nearest reseller, call 800-GO-EPSON (800-463-7766). Or you can purchase online at [www.epsonstore.com](http://www.epsonstore.com) (U.S. sales) or [www.epson.ca](http://www.epson.ca) (Canadian sales).

3. If you need to replace the filter, press up on the tab and lift off the cover.

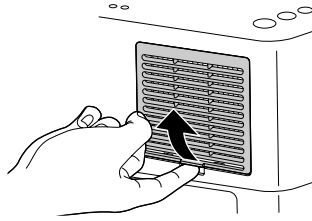

4. Remove the old filter and install the new filter.

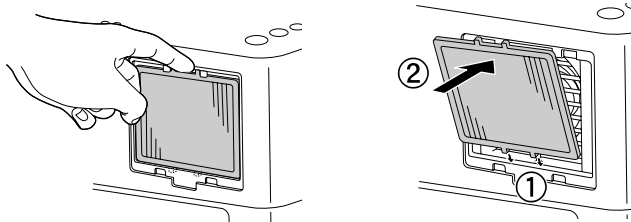

5. Replace the cover.

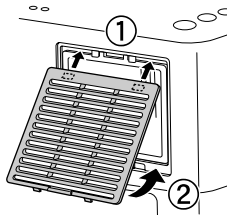

# Replacing the Lamp

The life span of the lamp is up to 3000 hours.

You can check how long the lamp has been used as described on page 44. If the number shown is close to the limit, make sure you have a spare lamp handy.

**Note:** Turn off this product when not in use to prolong the life of the projector.

It's time to replace the lamp when:

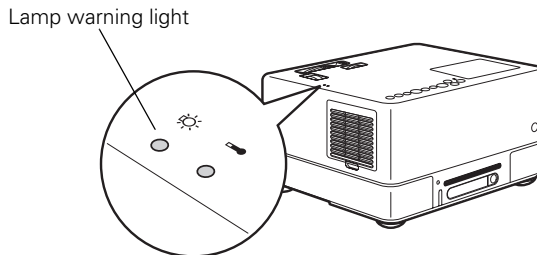

- The projected image gets darker or starts to deteriorate.
- The lamp warning light flashes orange.
- The message **Replace the lamp** appears on the screen when you start projecting.

**Caution:** If you continue to use the lamp after you see the replacement indicators, the lamp is more likely to break.

You can purchase a new lamp (part # V13H010L43) from an Epson authorized reseller. To find the nearest reseller, call 800-GO-EPSON (800-463-7766). Or you can purchase online at [www.epsonstore.com](http://www.epsonstore.com) (U.S. sales) or [www.epson.ca](http://www.epson.ca) (Canadian sales).

Be sure to read the safety instructions in the *Quick Guide* before replacing the lamp.

Follow these steps to replace the lamp:

1. Turn off the power and disconnect the power cord.
2. If the projector has been on, let it cool for at least an hour.

**Warning:** Let the lamp cool before replacing it. If the lamp breaks, handle the shards carefully to avoid injury.



3. Insert the screwdriver that came with the replacement lamp into the lamp cover release slot, pushing it in gently to release the lamp cover.

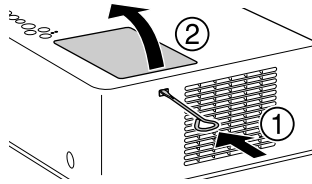

4. Loosen the two silver screws holding the lamp in place. (You can't remove these screws.)

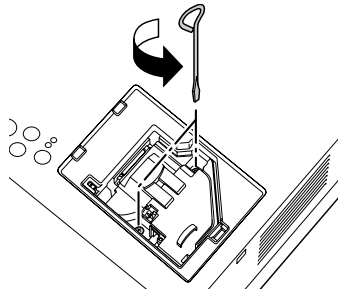

5. Grasp the lamp as shown and pull it straight out.

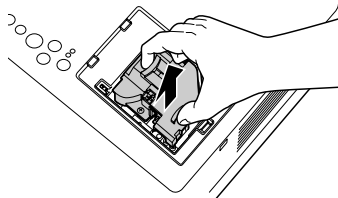

**Note:**  $\text{Hg}$  The lamp in this product contains mercury. Please consult your state and local regulations regarding disposal or recycling. Do not put in the trash.

6. Gently insert the new lamp and tighten its screws.

**Caution:** Don't touch the glass portion of the lamp with your bare hands; the invisible residue left by the oil on your hands may shorten the lamp life. Use a cloth or gloves to handle the new lamp assembly.

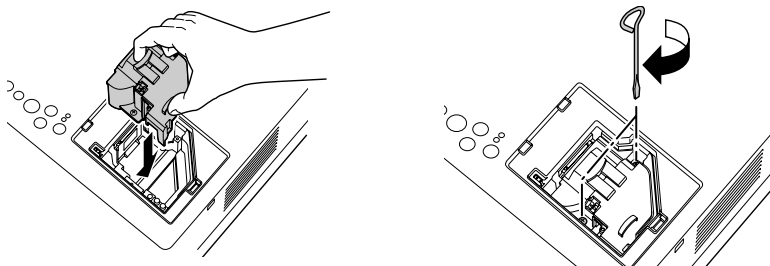



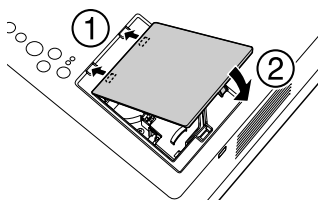

7. To replace the lamp cover, insert the tabs and then snap the cover into place. (MovieMate won't work if the lamp cover is loose.)



8. After replacing the lamp, you need to reset the lamp timer, as described in the next section.

## ***Resetting the Lamp Timer***

1. Connect the power cable and press the  button to turn MovieMate on.
2. Press  on the remote control. You see the Visual Setup menu.
3. Press  to highlight Info, then press  to select it.
4. Press  again. You see the following on the screen:

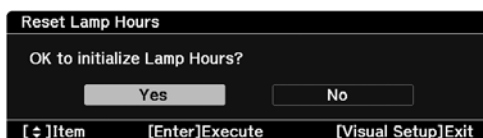

5. Select **Yes** and press  to reset the timer.

The lamp usage timer displays 0 H (zero hours) until you've used the lamp for at least 10 hours.

## Storing Epson MovieMate

Follow these guidelines when storing MovieMate:

- Make sure the temperature and humidity of the storage area are within the recommended range for the projector: 14 to 140 °F (–10 to 60 °C) and 10 to 90% relative humidity without condensation.
- Make sure all discs are ejected.
- Close the lens cover and retract the feet.
- Remove the batteries from the remote control.
- Package MovieMate in its original packaging or equivalent (as described in the following section).

## Transporting Epson MovieMate

**Note:** Epson shall not be liable for any damages incurred during transportation.

MovieMate contains many glass and precision parts. If you need to transport it, follow these guidelines to prevent damage:

- When shipping MovieMate for repairs, use the original packaging material if possible. If you do not have the original packaging, use equivalent materials, placing plenty of cushioning around MovieMate. Be sure the carrier is capable of transporting fragile equipment and is aware that MovieMate is fragile.
- If you move MovieMate from a cold environment into a warm room, condensation (moisture) may form internally or on the lens surface. To avoid damage that might be caused by condensation, wait approximately an hour before using MovieMate. If condensation forms, turn off the power, then wait an hour or two before use.
- When you are hand-carrying MovieMate, make sure all discs are ejected, the lens cover is closed, and the feet are retracted.
- Lift MovieMate as shown below. Make sure the top section is locked in place. Be careful not to open the interface cover while you are carrying MovieMate.

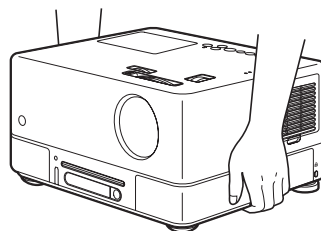

# Problem Solving

This section explains how to interpret MovieMate's status lights, solve problems, and contact technical support.

## What To Do When the Lights Flash

The lights on top of MovieMate indicate its status and let you know when a problem occurs. If all lights are off, make sure the power cable is connected correctly.

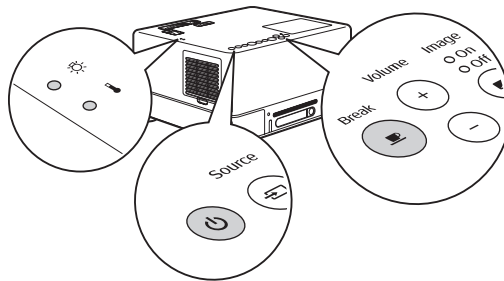

**The Image Off light is orange.**

MovieMate is in sleep mode. Press the  button to turn it on.

**The Image On light is flashing green.**

MovieMate is warming up. Wait for the picture to appear.

**The Image Off light is flashing orange.**

MovieMate is cooling down. Wait until the light stops flashing before you unplug MovieMate.

**The  button is flashing green.**

Press the  button to return to normal operation.

**The Image Off light is orange and the  light is green.**

Press  on the remote control or control panel to turn the lamp back on.

**The  warning light is flashing orange.**

High-speed cooling is in process. If MovieMate gets too hot again, projection stops automatically. Make sure MovieMate is at least 8 inches away from the wall.

Clean or replace the air filters if necessary (see page 46). If you are using MovieMate at an altitude above 4,900 feet (1500 meters), turn on High Altitude Mode (see page 44).

**The  warning light is flashing orange or red.**

The lamp needs to be replaced. See page 48.

**The  button is flashing orange and green and the  warning light is red.**



MovieMate is too hot and has turned off the lamp. Make sure MovieMate is at least 8 inches away from the wall.

Clean or replace the air filters if necessary (see page 46). If you are using MovieMate at an altitude above 4,900 feet (1500 meters), turn on High Altitude Mode (see page 44).



Let MovieMate cool for five minutes. When the Image Off light turns orange, press  to turn the lamp on. If the status doesn't change, wait a few minutes, then unplug MovieMate and contact Epson. See page 59.



**The  button is flashing orange and green and the  warning light is flashing red.**

The lamp may be incorrectly installed, the lamp cover may be loose, or the lamp may be broken. Turn off the power and check the lamp. See page 48. If the lamp is broken, or the lights continue to flash after you turn the power back on, unplug MovieMate and contact Epson. See page 59.

**The  button is flashing orange and green and the  warning light is flashing red.**

MovieMate has a problem with its fan or temperature sensor. Wait a few minutes, then unplug MovieMate and contact Epson. See page 59.

The  button is flashing orange and green and both  warning lights are flashing red.

MovieMate may have an internal error or cinema filter error. Wait a few minutes, then press . Unplug the power cable, then plug it in again and press . If the lights continue to flash, unplug MovieMate and contact Epson. See page 59.

---

## Solving MovieMate Operation Problems



### MovieMate doesn't turn on.

- Make sure the power cord is securely attached at both ends. Try using a different power outlet.  
If the power cord has been damaged, turn off MovieMate, disconnect the power cord, and contact Epson. See page 59.
- Make sure you pressed the  button.
- If the Image On light is flashing green, MovieMate is warming up. Wait for the picture to appear, which can take a few minutes.
- Make sure the Child Lock is not set. See page 40.

### MovieMate turns itself off after a period of time.

The power turns off automatically when MovieMate is idle for more than 30 minutes. Press the  button to turn on MovieMate. For instructions on changing the Sleep setting, see page 40.

### No picture appears on the screen.

- Make sure MovieMate is turned on (the  light is green). If the Image On light is flashing green, wait for MovieMate to warm up.
- Make sure the lens cover is open.
- The image may be off the screen. Use the quick image adjustment dials to adjust its position. See page 15.
- Press the  button on MovieMate or on the remote control to make sure the picture hasn't been turned off temporarily.
- Make sure the region code on the DVD is 1.

- Check the  warning light. If it is flashing orange or red, you need to replace the lamp. See page 48.
- The Screensaver feature turns off the picture if a still image is projected for more than 15 minutes. See page 40.
- If you're using external video equipment, check the solutions on page 58.

### **The DVD skips.**

- Make sure MovieMate is not tilted more than 15 degrees. This can cause skipping or disc scratches. Use the vertical image adjustment dial to adjust the image position. See page 15.
- Make sure there are no fingerprints on the DVD.

### **The remote control doesn't work.**

- Make sure the toggle switch is in the correct position: set to **-123** to use the numeric buttons, or to **Func.-** to use the other functions of these buttons.
- Make sure you're within 23 feet of MovieMate, and within range of its front or back sensor (approximately 30° left or right, and 15° above or below).
- You may need to replace the remote control's batteries. Make sure they're inserted with the positive (+) and negative (-) ends positioned as shown in the battery compartment.
- Some discs don't support all of the remote control's functions.
- If you're using a "universal" remote control, it might not work with MovieMate. Epson does not support any third-party remote controls.

---

## **Solving Picture and Sound Problems**

### **The picture is blurry or out of focus.**

- Adjust the focus using the focus ring. See page 15 for instructions.
- Make sure the lens cover is off.
- There may be dirt on the lens. Clean the lens as described on page 45.
- Make sure the lens is not fogged by condensation. If you've just moved MovieMate from a cold environment, wait approximately an hour before using it. If condensation forms, unplug MovieMate and wait an hour or two before use.

- Make sure MovieMate is placed the correct distance from the screen: no closer than 2.4 feet and no farther than 44.9 feet.
- Adjust the **Sharpness** setting. See page 41.
- If you're using the **Keystone** adjustment, be aware that it lessens image quality. You may want to decrease the projection angle to reduce the amount of keystone correction needed. Try adjusting MovieMate's position relative to the screen. Or, use the quick image adjustment dials to position the image.
- If you're using external video equipment, check the solutions on page 58.



### **The picture looks too light or too dark.**

- Press the  button on the remote control to select the best setting for your viewing environment. See page 20.
- Adjust the **Brightness** and **Contrast** settings. See page 41.
- If the picture looks darker than it used to, you may need to replace the lamp. See page 48.

### **The colors on the screen don't look right.**

- Press the  button on the remote control to select the best setting for your viewing environment.
- Adjust the **Color Saturation** or **Tint** settings. See page 41.
- If you're using external video equipment, check the solutions on page 58.

### **The picture is wider at the top or bottom.**

- You've tilted MovieMate to raise or lower the image, causing it to become "keystoned." Use the  or  buttons on the remote control to correct the problem.
- Better yet, place MovieMate at a height approximately between the top and bottom of the screen, keeping it level, and then use the vertical image adjustment dial to position the image. You won't have to correct for keystone distortion this way, and you'll get a better-looking image.

### **The picture is taller on the left or right side.**

MovieMate is set at an angle to the screen. Face it squarely toward the screen. Use the horizontal image adjustment dial to center the image. See page 15.

### **There is no sound, or the sound is not loud enough.**

- Try pressing the + **Volume** button on MovieMate or on the remote control.



- Press the  button on the remote control to make sure the sound hasn't been turned off temporarily.
- If you're using external video equipment, make sure you connected the red and white audio jacks to MovieMate's audio ports (see page 23).
- If you're using external equipment, you may need to adjust the Audio settings in the setup menu (see page 43).

### **There is a problem with the sound quality.**

- Try pressing the  button on the remote control and adjusting the sound mode.
- If you're using external equipment, you may need to adjust the Audio settings in the setup menu (see page 43).

### **There is no sound coming from an optional subwoofer.**

- Make sure you use an audio cable to connect the subwoofer to MovieMate.
- Make sure the optional subwoofer's power switch is turned on.
- Try adjusting the volume on the subwoofer.
- Try adjusting the volume on MovieMate.

### **Subtitles do not appear.**



- The DVD might not include subtitles.
- Make sure the subtitle language is not set to OFF (see page 36).

### **You can't change the language on a DVD.**

The DVD might not include multiple languages.

# Problems with External Video Equipment

## No picture appears on the screen.

- Make sure the equipment is turned on.
- Press the  button on MovieMate or on the remote control.
- Press the  or Play button on the external equipment.
- Make sure you don't have cables connected to more than one video port. You can only use one connection at a time (see page 23).

## You see the message No Signal.

- Make sure the equipment is turned on.
- Make sure your cable(s) are connected correctly (see page 23).
- Press the  button on MovieMate or the remote control to select the external video source. Allow a few seconds for MovieMate to sync up.

## You see the message Signal not supported.

Press the  button on the remote control and check the Video Signal setting (see page 43).



## The picture is cut off (too large) or too small.

Press the  button on the remote control and select the appropriate aspect ratio.

## The picture is distorted.

- If you're using an extension cable, electrical interference may affect the signal.
- Check the solutions on pages 55 and 56.

## The colors are not right.

- Press the  button on the remote control and check the Video Signal setting (see page 43).
- Press the  button on the remote control to select the best setting for your viewing environment.
- Adjust the Color Saturation or Tint settings. See page 41.

# Where To Get Help

Epson provides these technical support services:

## ***Internet Support***

Visit Epson's [U.S. support website](#) or [Canadian support website](#) for solutions to common problems. You can download utilities and documentation, get FAQ's and troubleshooting advice, or e-mail Epson with your questions.

## ***Speak to a Support Representative***

To use the Epson PrivateLine Support service, call (800) 637-7661 and enter the PIN on the included Epson PrivateLine Support card. This is the fastest way of speaking to a live representative, and it's free. This service is available 6 AM to 6 PM, Pacific Time, Monday through Friday, for the duration of your warranty period.

You may also speak with a projector support specialist by dialing one of these numbers:

- U.S.: (562) 276-4394, 6 AM to 6 PM, Pacific Time, Monday through Friday
- Canada: (905) 709-3839, 6 AM to 6 PM, Pacific Time, Monday through Friday

Toll or long distance charges may apply.

Before you call, please have the following information ready:

- Product name (Epson MovieMate 72)
- Product serial number (located on the bottom of MovieMate)
- Proof of purchase (such as a store receipt) and date of purchase
- Computer or video configuration
- Description of the problem

**Note:** If you need help with optional equipment, see the information included in the box with the equipment.

## ***Purchase Supplies and Accessories***

You can purchase screens, carrying cases, or other accessories from an Epson authorized reseller. To find the nearest reseller, call 800-GO-EPSON (800-463-7766). Or you can purchase online at [www.epsonstore.com](http://www.epsonstore.com) (U.S. sales) or [www.epson.ca](http://www.epson.ca) (Canadian sales).

# Specifications

## **General**

Type of display	Poly-silicon TFT active matrix
Size of LCD panels	0.55 inch (14 mm) wide
Lens	F=1.7 to 2.1, f=13.7 to 20.5 mm
Resolution (native format)	1280 × 720 pixels × 3, 720p
Brightness	up to 1200 lumens (ANSI)
Contrast ratio	up to 1000:1
Image size	30 to 300 inches (0.76 to 7.6 m)
Projection distance	2.4 to 44.9 feet
Speakers	Stereo speakers (5 W × 4)
Zoom ratio	1:1.5
Lens shift (maximum)	50% vertically, 25% horizontally
Optical aspect ratio	Native 16:9 (4:3 resize)
DVD Unit	Audio: Dolby Virtual Speaker, Dolby Pro Logic II, DTS Digital Surround Media: DVD Video, DVD-R/RW, DVD+R/RW, DVD-ROM, DVD Audio, CD-R/RW, CD-ROM, DVD-VR (without CPRM), Video CD, Super Video CD, Audio CD, MP3 (CD/DVD), WMA (CD/DVD), JPEG, DivX (CD/DVD), DivX Ultra (CD/DVD), Dual Disk See page 64 for detailed file specifications.
Noise level	28 dB to 32 dB
Keystone correction	Vertical: -15° to +15°
Tilt angle	up to 8°
HDMI	Version 1.2a

## ***Remote Control***

Range	Approx. 23 feet (7 m)
Battery	AA × 2
Operating angle	Horizontal: +/- 30° Vertical: +/- 15°

## ***Projection Lamp***

Type	140 W UHE (Ultra High Efficiency)
Part number	ELPLP43/ V13H010L43
Lamp life	Approx. 2000 hours Approx. 3000 hours in Theatre Black mode only

**Note:** Lamp life results will vary depending upon mode selected, environmental conditions, and usage.

Turn off this product when not in use to prolong the life of the projector.

## ***Dimensions***

Height	6.9 inches (174 mm) excluding feet
Width	12.9 inches (330 mm)
Depth	10.2 inches (260 mm)
Weight	15.2 lb. (6.9 kg)

## ***Electrical***

Rated voltage	100 to 240 VAC
Rated frequency	50/60 Hz
Power consumption	Operating: 260 W Standby: 5 W Lamp off: 95 W

## ***Environmental***

Temperature	Operating: 41 to 95 °F (5 to 35 °C) without condensation Storage: 14 to 140 °F (-10 to 60 °C) without condensation
Humidity	Operating: 20 to 80% RH, non-condensing Storage: 10 to 90% RH, non-condensing
Operating altitude	up to 7500 feet (2286 m)

## Safety and Approvals

United States                   FCC Part 15B Class B (DoC)  
  UL60950-1

Canada                            ICES-003 Class B  
  CSA C22.2 No.60950-1

## Compatible Video Formats

### *Composite video/S-Video*

<b>Signal</b>	<b>Resolution</b>	<b>Normal aspect mode</b>	<b>Wide aspect mode</b>	<b>Zoom aspect mode</b>
TV (NTSC)	720 x 480 720 x 360*	960 x 720 (4:3)	1280 x 720 (16:9)	1280 x 720 (16:9)
TV (PAL, SECAM)	720 x 576 720 x 432*	960 x 720 (4:3)	1280 x 720 (16:9)	1280 x 720 (16:9)

\* Letterbox signal

### *Component video*

<b>Signal</b>	<b>Resolution</b>	<b>Normal aspect mode</b>	<b>Wide aspect mode</b>	<b>Zoom aspect mode</b>
SDTV (525i, 60Hz)	720 x 480 720 x 360*	960 x 720 (4:3)	1280 x 760 (16:9)	1280 x 720 (16:9)
SDTV (625i, 50Hz)	720 x 576 720 x 432*	960 x 720 (4:3)	1280 x 760 (16:9)	1280 x 720 (16:9)
SDTV (525p)	720 x 480 720 x 360*	960 x 720 (4:3)	1280 x 760 (16:9)	1280 x 720 (16:9)
SDTV (625p)	720 x 576 720 x 432*	960 x 720 (4:3)	1280 x 760 (16:9)	1280 x 720 (16:9)
HDTV (720p) 16:9	1280 x 720	1280 x 720 (16:9)	—	—
HDTV (1080i) 16:9	1920 x 1080	1280 x 720 (16:9)	—	—

\* Letterbox signal

## HDMI video

Signal	Resolution	Normal aspect mode	Wide aspect mode	Zoom aspect mode
VGA60	640 x 480 640 x 360*	960 x 720	1280 x 720	1280 x 720
SDTV (525i, 60Hz)	720 x 480 720 x 360*	960 x 720	1280 x 720	1280 x 720
SDTV (525p,)	720 x 480 720 x 360*	960 x 720	1280 x 720	1280 x 720
SDTV (625i, 50Hz)	720 x 576 720 x 432*	960 x 720	1280 x 720	1280 x 720
SDTV (625p)	720 x 576 720 x 432*	960 x 720	1280 x 720	1280 x 720
HDTV (720p)	1280 x 720	1280 x 720	—	—
HDTV (1080i)	1920 x 1080	1280 x 720	—	—
HDTV (1080p, 24Hz)**	1920 x 1080	1280 x 720	—	—

\* Letterbox signal

\*\* The image may be distorted in the Game color mode.

## Computer image

Signal	Resolution	Normal aspect mode	Wide aspect mode	Zoom aspect mode
VGA 60/72/75/85, iMac*	640 x 480 640 x 360**	960 x 720	1280 x 720	1280 x 720
SVGA56/60/72/75/85/, iMac*	800 x 600 800 x 450**	960 x 720	1280 x 720	1280 x 720
XGA60/70/75/85, iMac*	1024 x 768 1024 x 576**	960 x 720	1280 x 720	1280 x 720
WXGA60-1	1280 x 768	1280 x 720	—	1280 x 720
WXGA60-2	1360 x 768	1280 x 720	—	1280 x 720
SXGA60/75/85	1280 x 1024 280 x 960**	960 x 720	1280 x 720	1280 x 720
MAC13"	640 x 480	960 x 720	1280 x 720	1280 x 720
MAC16"	832 x 624	960 x 720	1280 x 720	1280 x 720
MAC19"	1024 x 768	960 x 720	1280 x 720	1280 x 720

\* Only supported by models that include a VGA output port.

\*\* Letterbox signal

## File Specifications

Epson MovieMate supports MP3, WMA, DivX, DivX Ultra, and JPG files that conform to the following specifications:

File system	ISO9660 level 1 or level 2 (Discs that have been recorded in the packet write [UDF] format cannot be read.)
File name	Half-width English characters only, with .mp3, .wma, divx, avi., jpg, or .jpeg file extensions.
Group (folder) count	up to 298
Track (file) count	up to 648
Bit rate	MP3: 16 to 320 kbps; WMA: 64 to 192 kbps; DivX: Up to 3 mbps, 720 × 576 pixels, 30 fps optimum
Sampling frequency	16 kHz, 22.05 kHz, 24 kHz, 32 kHz, 44.1 kHz, 48 kHz
Total number of pixels	up to 3027 × 2048

Epson MovieMate can play multi-session recorded discs, but not multiple bit rate files. WAV and MPG files are not supported. Epson MovieMate supports baseline JPEG files created by a digital camera and conforming to the DCF (Design rule for Camera File system) standard. Motion JPEG files are not supported. Certain digital camera functions such as automatic rotation may not be supported.



Pixelworks™ DNX™ ICs are used in this projector.



## Language Codes

Abkhazian	6566	Gaelic; Scottish Gaelic	7168	Magyar	7285	Sinhalese	8373
Afar	6565	Gallegan	7176	Malayalam	7776	Slovensky	8373
Afrikaans	6570	Georgian	7565	Maltese	7784	Slovenian	8376
Amharic	6577	Gikuyu; Kikuyu	7573	Manx	7186	Somali	8379
Arabic	6582	Guarani	7178	Maori	7773	Sotho; Southern	8384
Armenian	7289	Gujarati	7185	Marathi	7782	South Ndebele	7882
Assamese	6583	Hausa	7265	Marshallese	7772	Sundanese	8385
Avestan	6569	Herero	7290	Moldavian	7779	Suomi	7073
Aymara	6589	Hindi	7273	Mongolian	7778	Swahili	8387
Azerhājani	6590	Hiri Motu	7279	Nauru	7865	Swati	8383
Bahasa Melayu	7783	Hrwatski	6779	Navaho; Navajo	7886	Svenska	8386
Bashkir	6665	Ido	7379	Ndebele, North	7868	Tagalog	8476
Belarusian	6669	Interlingua (International)	7365	Ndebele, South	7882	Tahitian	8489
Bengali	6678	Interlingue	7365	Ndonga	7871	Tajik	8471
Bihari	6672	Inuktitut	7385	Nederlands	7876	Tamil	8465
Bislama	6673	Inupiaq	7375	Nepali	7869	Tatar	8484
Bokmål, Norwegian	7866	Irish	7165	Norsk	7879	Telugu	8469
Bosanski	6683	Islenska	7383	Northern Sami	8369	Thai	8472
Brezhoneg	6682	Italiano	7384	North Ndebele	7868	Tibetan	6679
Bulgarian	6671	Ivrit	7269	Norwegian Nynorsk;	7878	Tigrinya	8473
Burmese	7789	Japanese	7465	Occitan; Provençal	7967	Tonga (Tonga Island)	8479
Castellano, Español	6983	Javanese	7486	Old Bulgarian; Old Slavonic	6785	Tsonga	8483
Catalán	6765	Kalaallisut	7576	Oriya	7982	Tswana	8478
Chamorro	6772	Kannada	7578	Oromo	7977	Türkçe	8482
Chechen	6769	Kashmiri	7583	Ossetian; Ossetic	7983	Türkmen	8475
Chewa; Chichewa; Nyanja	7889	Kazakh	7575	Pali	8073	Twi	8487
中文	9072	Kernewek	7587	Panjabi	8065	Uighur	8571
Chuang; Zhuang	9065	Khmer	7577	Persian	7065	Ukrainian	8575
Church Slavic; Slavonic	6785	Kinyarwanda	8287	Polski	8076	Urdu	8582
Chuvash	6786	Kirghiz	7589	Português	8084	Uzbek	8590
Corsican	6779	Komi	7586	Pushto	8083	Vietnamese	8673
Česky	6783	Korean	7579	Russian	8285	Volapuk	8679
Dansk	6865	Kuanyama; Kwanyama	7574	Quechua	8185	Walloon	8765
Deutsch	6869	Kurdish	7585	Raeto-Romance	8277	Welsh	6789
Dzongkha	6890	Lao	7679	Romanian	8279	Wolof	8779
English	6978	Latina	7665	Rundi	8278	Xhosa	8872
Esperanto	6979	Latvian	7686	Samoan	8377	Yiddish	8973
Estonian	6984	Letzeburgesch;	7666	Sango	8371	Yoruba	8979
Euskara	6985	Limburgan; Limburger	7673	Sanskrit	8365	Zulu	9085
Ελληνικά	6976	Lingala	7678	Sardinian	8367		
Faroese	7079	Lithuanian	7684	Serbian	8382		
Français	7082	Luxembourgish;	7666	Shona	8378		
Frysk	7089	Macedonian	7775	Shqip	8381		
Fijian	7074	Malagasy	7771	Sindhi	8368		

# Index

## A

- Accessories, 7, 59
- Air filter
  - cleaning and replacing, 46 to 47
  - ordering, 7
- Air vents, 8
- Audio
  - adjusting, 18, 21, 43
  - problems, 56 to 57
- Audio system connection, 29
- AV amplifier, connecting, 29

## B

- Blurry picture, 55 to 56
- Brightness
  - adjusting, 42
  - lamp, 48, 60
- Buttons, 9

## C

- Cable box, connecting, 23 to 26
- Camcorder, connecting, 23 to 26
- Camera angle, 36
- CDs, playing, 32
- Child Lock, 40
- Cleaning
  - air filter, 46 to 47
  - lens and MovieMate case, 45 to 46
- Color mode, 20, 56, 58
- Color problems, 56, 58
- Composite video connection, 23
- Computer connection, 30 to 31
- Contrast ratio, 60
- Control panel, MovieMate, 9

## D

- Dark image, 56
- Digital audio recorder, connecting, 29
- Digital camera, connecting, 23 to 26
- Distance, projection, 12, 60
- Documentation, 7
- DVDs
  - menus, 20
  - playing, 11 to 22
- DVR, connecting, 23 to 26

## E

- Electrical specifications, 61
- Environmental specifications, 61
- Epson
  - accessories, 7, 59
  - Home Service, 6
  - PrivateLine Support, 59
  - technical support, 7, 59
- Exhaust vent, 8
- External equipment
  - connecting, 23 to 31
  - problems, 58

## F

- Fast forward, 19
- File specifications, 64
- File type setting, 42
- Filter, *see* Air filter
- Focus ring, 16
- Formats, video, 62 to 63

## G

Game console, connecting, 23 to 26  
General specifications, 60

## H

Headphones, 22  
Help, 7, 59  
High altitude mode, 44, 53  
Home Service, 6  
Horizontal lens shift, 12, 15

## I

Image  
    blurry, 55 to 56  
    distorted, 56  
    shape, 56, 60  
    size, 12, 60  
    too light or dark, 56  
    turning off, 20  
    wrong colors, 56  
Image adjustment dials, 12, 15, 60  
Intake vent, 8  
iPod, connecting, 23 to 26

## J

Jog control, 19  
JPEG, 33, 42, 64

## K

Kensington lock, 7  
Keystone correction, 56, 60

## L

Lamp  
    brightness, 48, 60  
    light, 53 to 54  
    ordering, 7, 48  
    replacing, 48 to 50  
    specifications, 61  
    usage timer, resetting, 44, 50  
Language, 36, 41, 65  
Laptop connection, 30 to 31  
Lens shift, 12, 15, 60  
Lens, cleaning, 45  
Lights, MovieMate, 52 to 54  
Location, MovieMate, 11 to 13  
Lock, security, 7  
Locking Power button, 40  
Looping, 35

## M

Maintenance, 45 to 50  
Menus, 20  
MovieMate  
    choosing location, 11 to 13  
    cleaning, 46  
    control panel, 9  
    dimensions, 61  
    distance from screen, 12, 60  
    lights, 52 to 54  
    maintenance, 45 to 50  
    operation problems, 54 to 55  
    parts, 8  
    positioning, 11 to 13  
    speakers, 60  
    specifications, *see* Specifications  
    storing, 51  
    transporting, 51  
Movies  
    pausing, 18  
    playing, 11 to 22  
    searching, 19  
MP3, 33, 42, 64  
Music, playing, 32 to 34  
Muting, 20

## N

No Signal message, 58

## O

Optical audio-out port, using, 29  
Optional accessories, 7  
Optional subwoofer connection, 28  
Overheating, 13, 46, 53

## P

Parental controls, 39  
Parts, identifying, 8 to 9  
Pausing, 18  
PBC (Playback Control), 37  
Photos, displaying, 32 to 34  
Picture  
    adjusting, 15, 20, 42 to 44  
    problems, 54 to 56  
Pixelworks DNX, 62  
Positioning MovieMate, 11 to 13  
Power button locking, 40  
Power, saving, 40  
Problems  
    audio, 56 to 57  
    color, 56, 58  
    lights indicating, 52 to 54  
    operation, 54 to 55  
    overheating, 13, 46, 53  
    picture, 54 to 56  
    remote control, 55  
Program play, 35  
Projection distance, 12, 60

## R

Registration, 6  
Remote control  
    buttons, 9  
    problems, 55  
    specifications, 61  
Repeating scenes or tracks, 35

Replacing lamp, 48 to 50  
Resetting lamp timer, 44, 50  
Resolution, 60

## S

Safety approvals, 62  
Satellite receiver, connecting, 23 to 26  
Screen distance, 12, 60  
Screen projection, 13 to 15  
Screen saver setting, 42  
Searching, 19  
Shuttle control, 19  
Signal not supported message, 58  
Size, image, 12, 60  
Skipping chapters or tracks, 19  
Sleep mode, 40, 52, 54  
Slow motion, 19  
Sound  
    adjusting, 18, 21, 43  
    problems, 56 to 57  
Sources, switching, 58  
Speakers, MovieMate, 60  
Specifications  
    compatible video formats, 62 to 63  
    electrical, 61  
    environmental, 61  
    file specifications, 64  
    general, 60  
    lamp, 61  
    language codes, 65  
    remote control, 61  
Storing MovieMate, 51  
Subtitles, 36  
Subwoofer, optional connection, 28  
Support, *see* Technical support  
Surround sound system, connecting, 29  
S-Video connection, 24

## **T**

Technical support, 7, 59  
Temperature, MovieMate, 46, 53  
Transporting MovieMate, 51  
TV video formats, 62 to 63

## **U**

USB devices, 27

## **V**

VCR, connecting, 23 to 26  
Ventilation, 13, 46, 53  
Vents, 8  
Vertical lens shift, 12, 15  
Video camera, connecting, 23 to 26  
Video, compatible formats, 62 to 63  
Volume, adjusting, 18

## **W**

Wall projection, 13 to 15  
Warranty, 6  
WMA, 33, 42, 64

## **Z**

Zoom ring, 16  
Zooming, 19