



Epson MovieMate™ 30s Series

User's Guide



Copyright Notice

All rights reserved. No part of this publication may be reproduced, stored in a retrieval system, or transmitted in any form or by any means, electronic, mechanical, photocopying, recording, or otherwise, without the prior written permission of Seiko Epson Corporation. The information contained herein is designed only for use with this Epson product. Epson is not responsible for any use of this information as applied to other products.

Neither Seiko Epson Corporation nor its affiliates shall be liable to the purchaser of this product or third parties for damages, losses, costs, or expenses incurred by purchaser or third parties as a result of: accident, misuse, or abuse of this product or unauthorized modifications, repairs, or alterations to this product, or (excluding the U.S.) failure to strictly comply with Seiko Epson Corporation's operating and maintenance instructions.

Seiko Epson Corporation shall not be liable for any damages or problems arising from the use of any options or any consumable products other than those designated as Original Epson Products or Epson Approved Products by Seiko Epson Corporation.

Responsible Use

This unit is equipped with Macrovision copy protection. The intellectual property rights to the patent of this copy protection technology are owned by the Macrovision Company of America, and others. When employing this technology, a license is required from the Macrovision Company. The Macrovision Company does not authorize the use of this technology except for a limited range of intended purposes, including home use. Further, remodeling, disassembly, and reverse engineering are prohibited.

Reproduction of a disc for the purposes of broadcast, projection in public, public musical performance, or rental (regardless of compensation, remuneration, or lack thereof) without the permission of the copyright owner, is strictly prohibited.

Trademarks

Epson is a registered trademark and Exceed Your Vision is a trademark of Seiko Epson Corporation.

MovieMate is a trademark, PrivateLine is a registered trademark, and Extra Care and Epson Connection are service marks of Epson America, Inc.

Pixelworks, DNX, and the DNX logo are trademarks of Pixelworks, Inc.

General Notice: Other product names used herein are for identification purposes only and may be trademarks of their respective owners. Epson disclaims any and all rights in those marks.

Contents

Welcome!	7
Registration and Warranty	7
Optional Accessories	8
About This Manual	8
MovieMate 30s Parts and Controls	9
Playing Movies	11
Choosing a Location	11
Setting Up MovieMate	13
Starting a DVD Movie	14
Adjusting the Picture	15
Adjusting the Sound	16
Turning Off MovieMate	16
Controlling Playback	18
Pausing	18
Searching (Fast Forward or Reverse)	19
Playing in Slow Motion	19
Skipping	19
Replaying a Scene	19
Using DVD Menus	20
Temporarily Stopping Audio or Video	20
Adjusting the Color Mode	20
Listening with Headphones	21

Using MovieMate With Other Equipment	23
Viewing Video from External Devices	23
Using the Optional Subwoofer	26
Playing Audio From a Digital Audio Device	27
Playing MovieMate Audio Through an External Audio System	28
Connecting a Computer or Laptop	29
Wall and Projection Screen Recommendations	30
Viewing on a Wall	30
Viewing on a Projection Screen	30
Doing More with MovieMate	33
Playing Music and Displaying Photos	33
Playing Music CDs	33
Playing MP3/WMA Music and JPEG Photo Files on Disc	34
Using Advanced Playback Controls	35
Repeating a Chapter, Title, or Track	35
Repeating a Scene	35
Changing the Play Sequence (Program Play)	36
Playing at Random	36
Selecting Language, Subtitles, and Camera Angles	37
Searching for a Specific Time	37
Playing Video CDs with Playback Control (PBC)	38
Customizing MovieMate	39
Setting Parental Controls	39
Locking the Power Button on the Control Panel	40
Locking the Tray	40
Saving Power	40
Changing Language Settings	41
Adjusting the Resume and On-Screen Guide Settings	41
Adjusting General Audio Settings	42
Adjusting DVD Movie Sound Levels	42

Adjusting Detailed Audio Settings	42
Adjusting Picture Settings	43
Adjusting Picture Quality	44
Viewing and Adjusting Video Information	45
Disabling Progressive Mode	45
Changing the Display Window Brightness	46
Caring for MovieMate	47
Protecting MovieMate	47
Cleaning the Lens	47
Cleaning MovieMate's Case	48
Cleaning and Replacing the Air Filter	48
Replacing the Lamp	49
Resetting the Lamp Timer	52
Storing MovieMate	52
Transporting MovieMate	53
Problem Solving	55
What To Do When the Lights Flash	55
Solving MovieMate Operation Problems	57
Solving Picture and Sound Problems	58
Problems with External Video Equipment	61
Where To Get Help	62
Internet Support	62
Speak to a Support Representative	62
Purchase Supplies and Accessories	62

Specifications and Notices	63
MovieMate Specifications	63
Important Safety Information	68
FCC Compliance Statement	70
Declaration of Conformity	71
Epson America, Inc. Limited Warranty	71
Index	73

Welcome!

Your Epson MovieMate™ 30s Series is a portable, lightweight home cinema system that delivers high-quality, big-screen entertainment anywhere you want. In less than two minutes, you can set up MovieMate and watch a DVD, play a video game, or view your favorite photos.

MovieMate offers these outstanding features:

- Flexibility to set up in any room (or even outdoors), from 2.4 feet to 37 feet away from a screen or wall
- DVD resolution of 480p
- Widescreen viewing with 16:9 aspect ratio
- Up to 1200 ANSI lumens of brightness, enough for viewing in daylight
- 1000:1 contrast ratio, for deep, vibrant images
- JVC® DVD player with Dolby® Digital and DTS
- Built-in JVC speakers with stereo sound
- Long-life bulb providing up to 3000 hours of use
- Two-year home service warranty

Registration and Warranty

The Epson MovieMate 30s comes with a basic two-year carry-in warranty. For details, see page 71.

In addition, Epson® offers free Extra CareSM Home Service during your warranty period. In the unlikely event of an equipment failure, you won't have to wait for your unit to be repaired. Instead, Epson will ship you a replacement unit anywhere in the United States or Canada, usually via overnight delivery. See your Extra Care Home Service brochure for details.

We encourage you to register your projector. To register, simply fill out the registration card that came with your projector and mail it to Epson. Or you can register online at <http://www.epson.com/webreg>. Registering also lets you receive special updates on new accessories, products, and service.

Optional Accessories

Epson provides these replacement parts and optional accessories for the MovieMate 30s:

Product	Part number
Replacement lamp (ELPLP33)	V13H010L33
Replacement air filter (ELPAF09)	V13H134A09
Rolling carrying bag (ELPKS56)	V12H001K56
Kensington® security lock	ELPSL01
Powered matching subwoofer (40 W)	For details on these optional accessories, see www.epson.com/homeentertainment
Portable 80" 16:9 floor standing and wall-mountable screens	
Ceiling-mountable 16:9 screens	
Wireless 5.1 Surround Sound System adapter	

You may be able to purchase these accessories from an Epson authorized reseller. To contact the nearest reseller, call 800-GO-EPSON (800-463-7766). Or you can purchase online at www.epsonstore.com (U.S. sales) or www.epson.ca (Canadian sales).

About This Manual

See the *Quick Setup* sheet to set up your MovieMate. This book contains information on using MovieMate, troubleshooting tips, specifications, and warranty information.

Please follow these guidelines as you read through the manual:

Warnings: Must be followed carefully to avoid bodily injury.

Cautions: Must be observed to avoid damage to your equipment.

Notes: Contain important information about your equipment.

Tips: Contain helpful projection tips.

Need additional help? Take advantage of Epson's automated support services 24 hours a day at <http://support.epson.com>. Use this site to view FAQs (Frequently Asked Questions) or product information and e-mail your questions to Epson support.

If you need more help, you can use the Epson PrivateLine® Support service. Call (800) 637-7661 and enter the PIN on the PrivateLine support card that came with MovieMate.

MovieMate 30s Parts and Controls

Front View

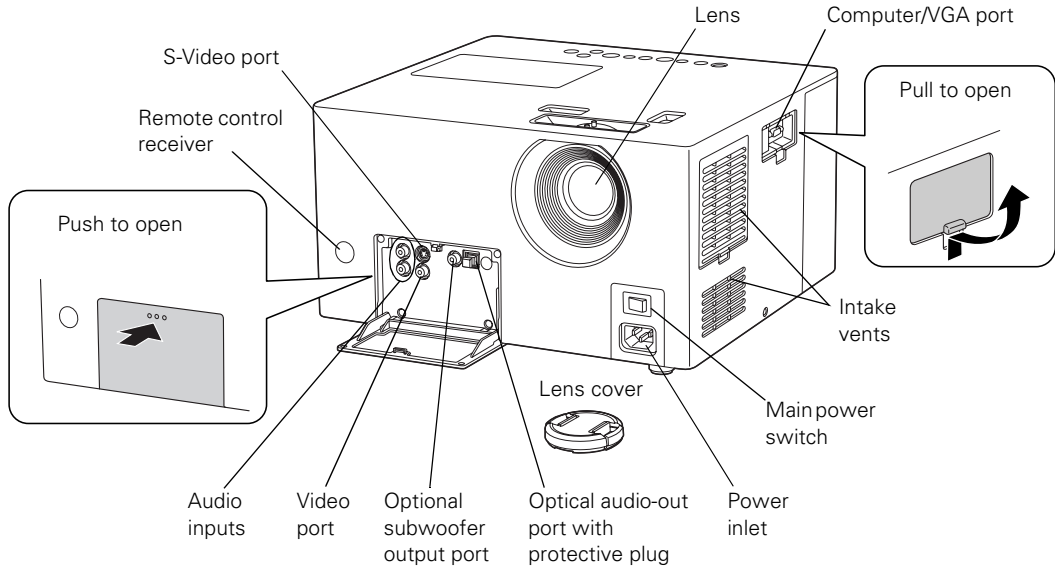

Back View

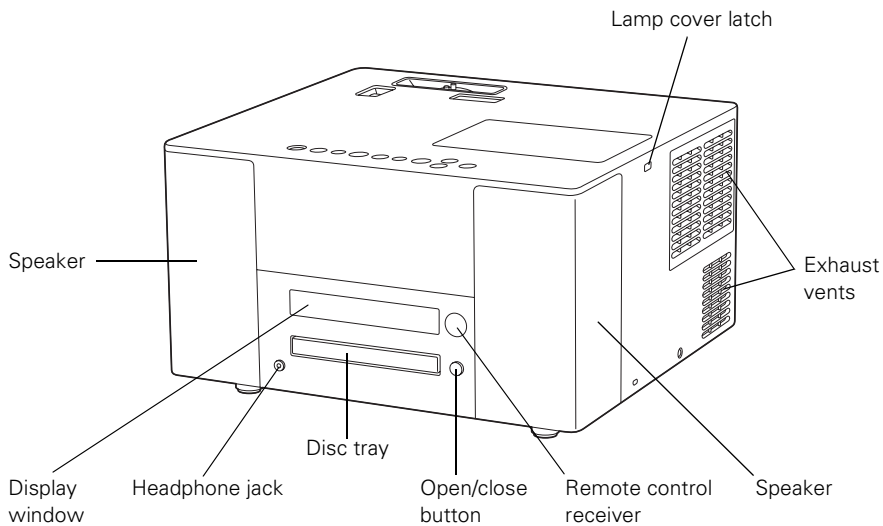

Top View

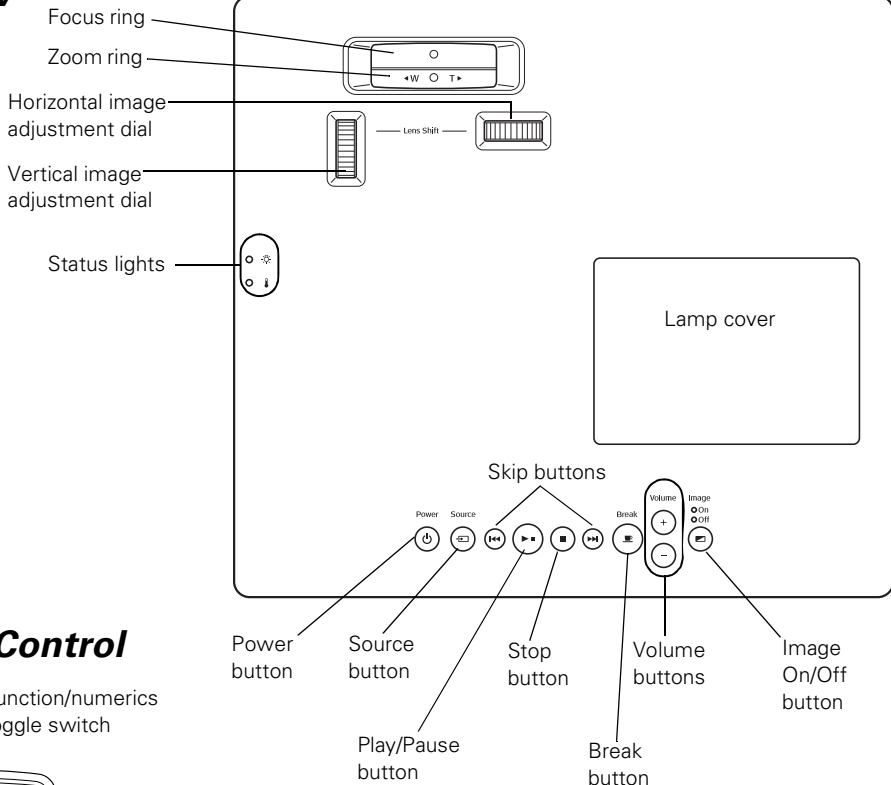

Remote Control

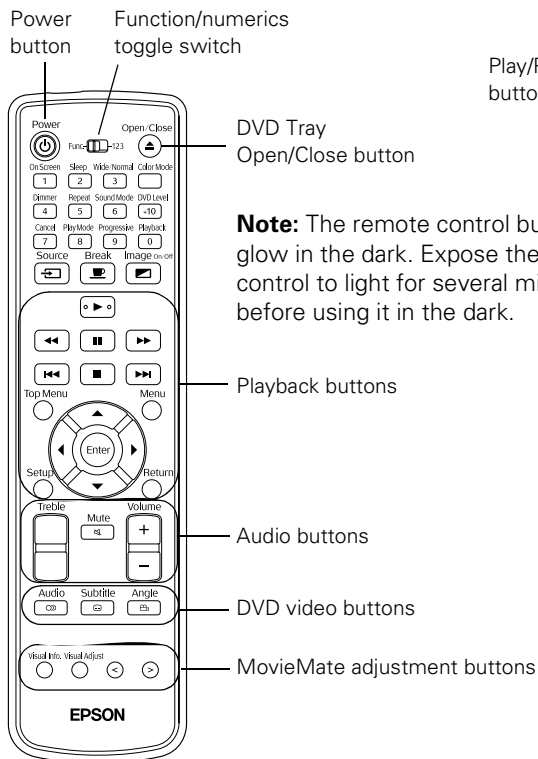

Note: The remote control buttons can glow in the dark. Expose the remote control to light for several minutes before using it in the dark.

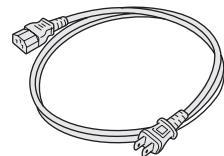

Power cord (10 feet long)

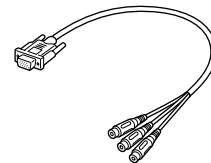

VGA-to-component video cable adapter

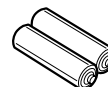

2 batteries for remote control

Playing Movies

Follow the instructions in this section to choose a location, play a DVD movie, and control playback.

Choosing a Location

You can use your MovieMate just about anywhere—in the living room, bedroom, or even outside. You can use it with the optional subwoofer and an optional floor-, wall-, or ceiling-mounted screen, or simply project on a flat white wall and use the built-in audio system.

The following pictures show four different setups:

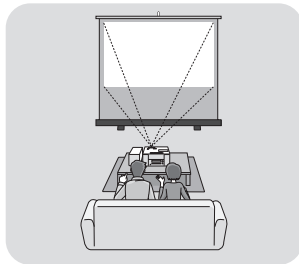

Front

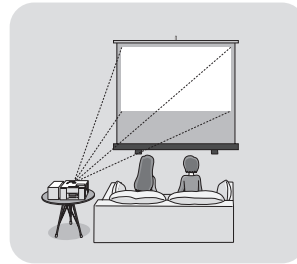

Side

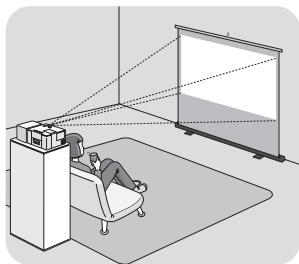

Back

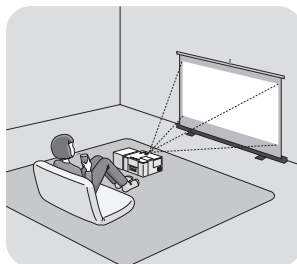

Floor

To project onto a wall, choose a flat white wall with a smooth surface. When you find a suitable wall for projection, you may want to consider coating the area with projection paint to enhance the image quality. For details, see “Wall and Projection Screen Recommendations” on page 30.

MovieMate doesn't have to be directly in front of the screen or wall, but it has to face straight ahead (at a 90-degree angle to the surface). If the image is too low, too high, or off to the side, you can use the quick image adjustment dials to adjust the position (see page 15).

The further you place MovieMate from the screen or wall, the larger the image will be.

The following table lists the distances required for various image sizes (measured diagonally). Note that the zoom adjustment also affects image size.

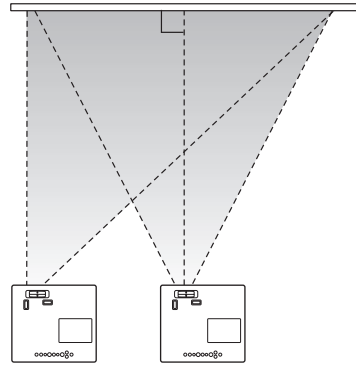

Wide screen aspect ratio (16:9)

Image size	Projection distance
30 in. (26 × 15 in.)	2.4 to 3.7 ft.
40 in. (35 × 20 in.)	3.2 to 4.9 ft.
60 in. (51 × 28 in.)	4.9 to 7.4 ft.
80 in. (71 × 39 in.)	6.6 to 9.9 ft.
100 in. (87 × 47 in.)	8.2 to 12.4 ft.
150 in. (130 × 75 in.)	12.4 to 18.6 ft.
300 in. (261 × 147 in.)	24.8 to 37.3 ft.

Standard aspect ratio (4:3)

Image size	Projection distance
30 in. (24 × 18 in.)	2.9 to 4.5 ft.
40 in. (32 × 24 in.)	4 to 6 ft.
60 in. (47 × 35 in.)	6 to 9 ft.
80 in. (63 × 47 in.)	8 to 12.1 ft.
100 in. (79 × 59 in.)	10.1 to 15.2 ft.
150 in. (118 × 91 in.)	15.1 to 22.8 ft.
300 in. (240 × 180 in.)	30.4 to 45.7 ft.



When setting up MovieMate, keep these considerations in mind:

- Make sure you don't block the air vents on the sides.
- Make sure you place MovieMate within 10 feet of an electrical outlet, power strip, or extension cord.
- Do not tilt MovieMate more than 5 degrees up or down.

Setting Up MovieMate

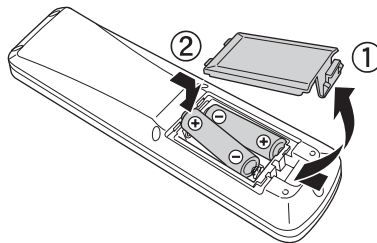

1. If you have an optional screen, set it up following the instructions included in the screen box. Make sure you read all the instructions to avoid damaging the screen.
2. Put the batteries in the remote control.

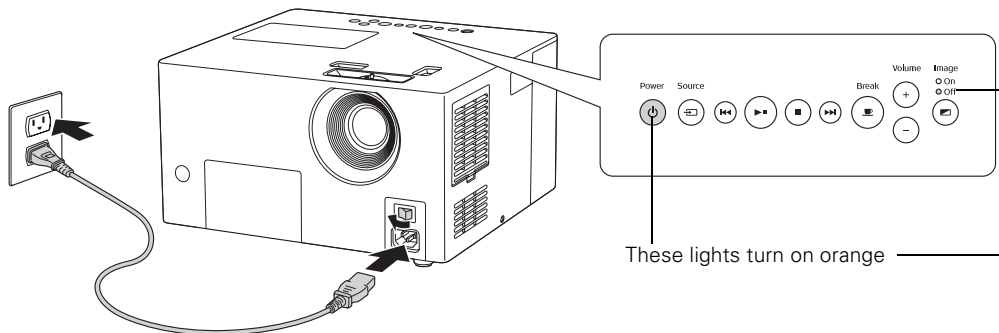

3. The remote control buttons can glow in the dark. Expose the remote control to light for several minutes before using it in the dark.
4. Plug in MovieMate, then turn it on using the power switch. The  Power and  Image Off lights turn on orange.



Starting a DVD Movie

1. Press the  button to open the DVD tray.
2. Insert your DVD and close the tray. If the movie doesn't start automatically, you may have to press the  Power button or the  Image On/Off button.

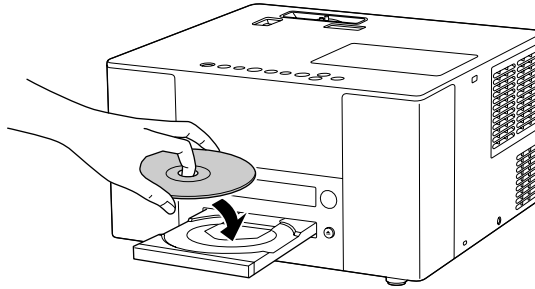

3. Adjust the volume if necessary.

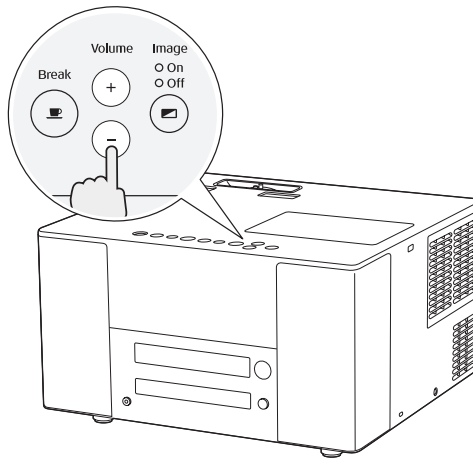

Adjusting the Picture

Once you see your picture, you may need to make certain adjustments.

1. If the image is too low, too high, or off to the side, use the quick image adjustment dials to adjust its position.

Note: The image adjustment feature cannot move the image both horizontally and vertically by the full amount. For example, if you have moved the image all the way up, then you cannot shift it all the way to the right or left at the same time.

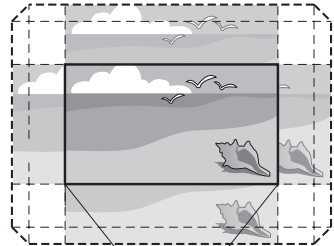

2. Rotate the zoom ring to reduce or enlarge the picture.

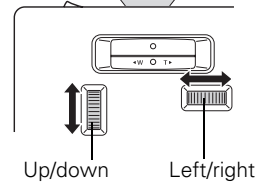
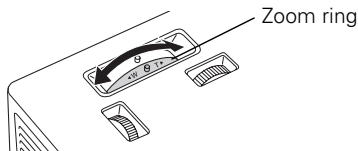
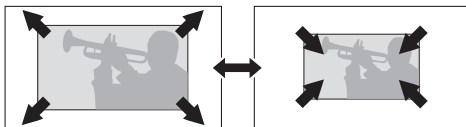

Quick image adjustment dials

3. Rotate the focus ring to sharpen the picture.

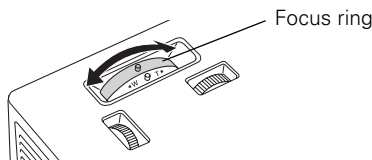
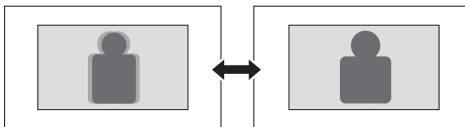



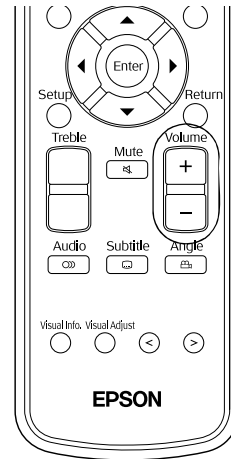
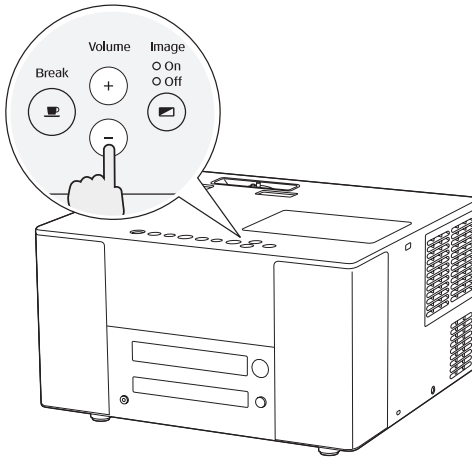

4. To enlarge or reduce the aspect ratio of the picture, press the ^{Wide/Normal} **3** button on the remote control to select **Normal**, **Wide**, or **Zoom** (if available for the video source you're using). (Make sure the toggle switch on the remote control is set to the **Func.-** position.)

Adjusting the Sound

To adjust the volume, use the + or – Volume buttons on MovieMate’s control panel or on the remote control.



Turning Off MovieMate

1. To stop playing a DVD or CD, press  on the remote control or on MovieMate’s control panel.
2. Press the  button to open the tray.
3. Remove the disc and press  again to close the tray.
4. Press  Power. The lamp turns off. When it cools down, MovieMate beeps twice.

5. Turn off the main power switch.

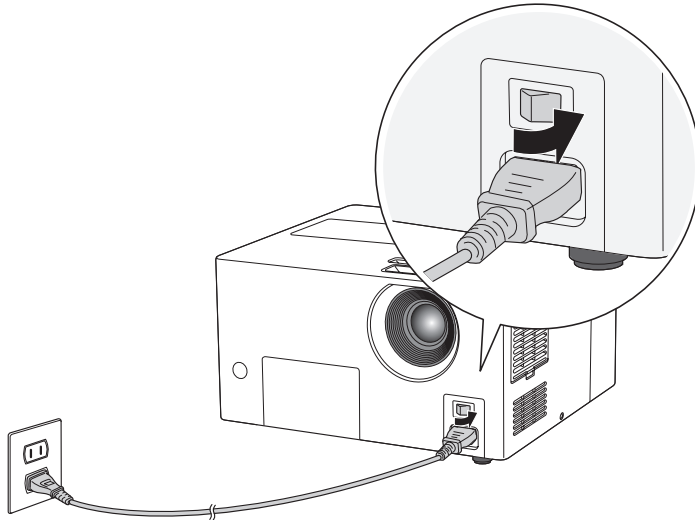

Note: Turn off this product when not in use to prolong the life of the projector.

6. Unplug MovieMate.
7. Before you put MovieMate away, attach the lens cover to protect the lens from dirt or damage.

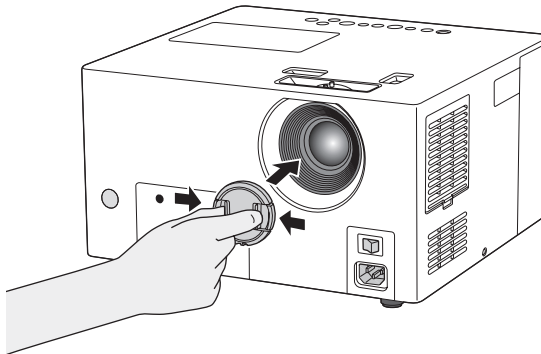



Controlling Playback



You can use the buttons on the remote control or the MovieMate control panel to pause, fast-forward, or replay sections of your video or audio. You can also select items on a DVD menu by using the remote control.

Note: DVD movies are divided into units called titles. Each title may contain any number of chapters. Music CDs and video CDs are divided into tracks.



Pausing

There are three ways to pause a movie or audio track with MovieMate:







- To pause a movie, or a music CD or MP3 player track, press  on the remote control or  on the control panel.

To resume, press  on the remote control, or  on the control panel.

- To pause a movie and darken the image on the screen or wall, press  on the remote control or control panel.

To resume, press  on the remote control, or  on the control panel.

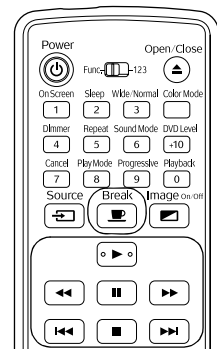

- To pause a movie and light up the screen or wall temporarily (so you can see better in a dim or dark room), press  on the remote control or control panel.

To resume, press  again. Pressing any of the following buttons also cancels break mode: , , , , .



Note: After 5 minutes in break mode, the lamp turns off and the screen darkens. After 30 minutes, the power shuts off, and you need to press the  Power button to turn it on again.

Searching (Fast Forward or Reverse)

- To move forward or backward through a video or music CD, press  or  on the remote control.

You can also press and hold  or  on the control panel.



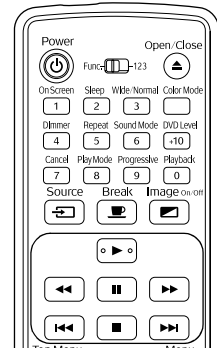

Each time you press the button, the search (or “shuttle”) speed increases.

- To return to normal play, press .





Playing in Slow Motion

You can play a video frame by frame or in slow motion (“jog control”).

1. Press  on the remote control.
2. Press  repeatedly to advance the video frame by frame.
3. Press  or  to move forward or backward in slow motion. Each time you press the button, the speed increases.
4. Press  to return to normal play.

Skipping







- To skip to the next chapter or track, press  on the remote control.
- To return to the start of the current chapter or track, press  on the remote control.

Replaying a Scene











To replay the previous 10 seconds within the same DVD title, press  (not available on all DVDs). (Make sure the toggle switch on the remote control is set to the **Func.**- position.)

Using DVD Menus

Many DVDs display a top menu at startup and include submenus that let you select chapters.



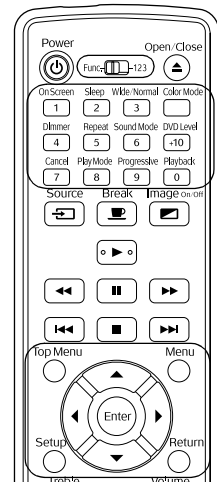

- To display a menu, press  or .
- To select items in a menu, press , , , or . Then press  if necessary.

You can also select a title or chapter by number.

- If you want to use the numeric buttons, you need to set the toggle switch on the remote control to the -123 position.
- After you set the toggle switch, you can simply press the numeric button for the numbers 1 through 9.
- To enter the number 10, press , then press .
- To enter the number 15, press , then press .
- To enter the number 20, press , then  again, then .
- To enter the number 25, press , then  again, then .
- After entering your number, you may need to press the  button.





Temporarily Stopping Audio or Video

- To temporarily stop the soundtrack (from the built-in speakers, headphones, and optional subwoofer), press . The video continues to play.
Press  again to resume.
- To temporarily stop the video (turn off the lamp and darken the screen), press . The soundtrack continues to play.
Press  again to resume.

Adjusting the Color Mode

You can select a color mode to optimize picture quality based on the lighting conditions in the room.

1. Press . The currently selected color mode is displayed on the screen.
2. Press  repeatedly until the desired color mode appears. After a few seconds, the color mode name disappears and the picture quality changes.

You can select from the following color modes:

- **Dynamic:** Use in rooms with some light.
- **Living Room:** Use in rooms with the blinds or drapes closed.
- **Theatre:** Use in rooms with the blinds or drapes closed and the lights off; the Epson cinema filter automatically provides more natural skin tones.
- **Theatre Black:** Use in completely darkened rooms; the Epson cinema filter automatically provides more natural skin tones.

Listening with Headphones

Connect headphones as shown below:

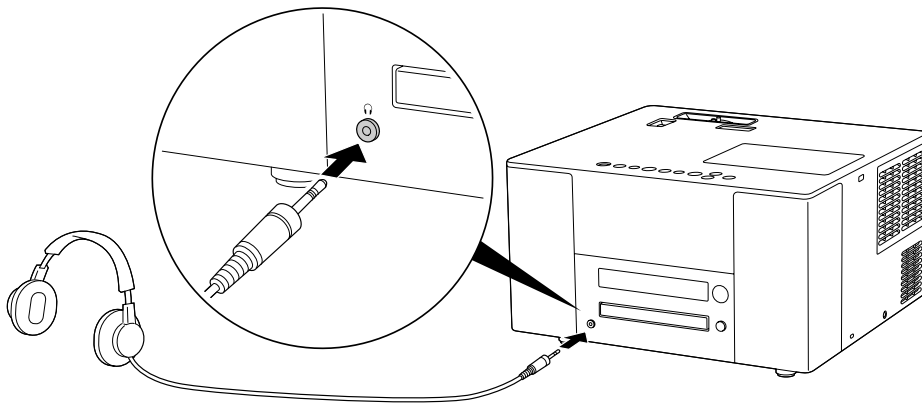

After you connect headphones, you no longer hear any sound from the built-in speakers or the optional subwoofer. However, you can still adjust the volume to the headphones using MovieMate's volume controls on the control panel or remote control.

Warning: Make sure the volume is not set too high, especially when you first plug in the headphones. Listening to high volume sounds over an extended period can damage your hearing. Sudden high volume can also damage your headphones.

Using MovieMate With Other Equipment

You can connect a variety of video, audio, and computer equipment to MovieMate to further enhance your viewing and listening experience.

- Video equipment such as a VCR, DVR, cable or satellite TV receiver, game console, video camera, digital camera, video or photo iPod, or other device that has a video output port
- Optional subwoofer for rich, powerful bass tones
- Audio input equipment such as an iPod or other MP3 player to play music through MovieMate
- Audio output equipment such as an AV amplifier, 5.1 Stereo Surround Sound System, or other audio equipment to play audio from MovieMate
- Computer or laptop to project anything you can see or hear on your computer through MovieMate.

You can also enhance your viewing experience by following the recommendations for wall and screen viewing on page 30.

Viewing Video from External Devices

You can connect to external video devices that have composite video, S-Video, or component video ports. To play audio from these sources, you also need to connect standard white and red audio jacks to MovieMate's L and R Audio inputs.

Note: If your device has both composite and S-Video ports, use S-Video for higher quality.

When you view video from an external source, you can use most of MovieMate's controls, including adjusting color mode, volume, DVD level, and sound mode.

You will need connection cables, which may be included with your external equipment, or may be purchased from an electronics store.

Caution: Before connecting, make sure all equipment is turned off.

1. Connect the external equipment as shown, using either the yellow composite video port, the S-Video port, or a component video cable and the adapter cable that came with MovieMate.

Composite Video Connection

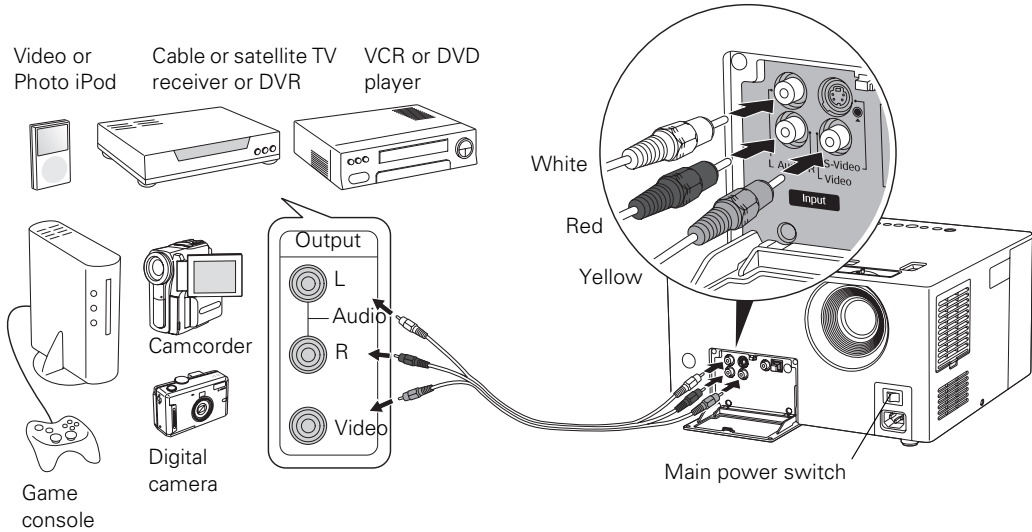

S-Video Connection

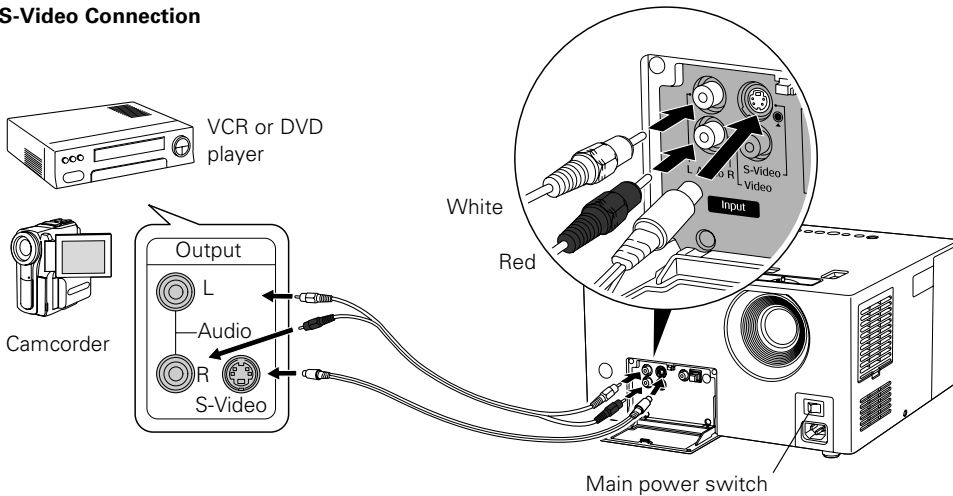



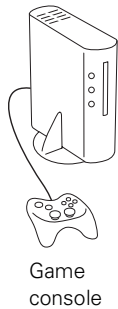
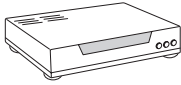

Component Video Connection

Cable or satellite TV receiver or DVR

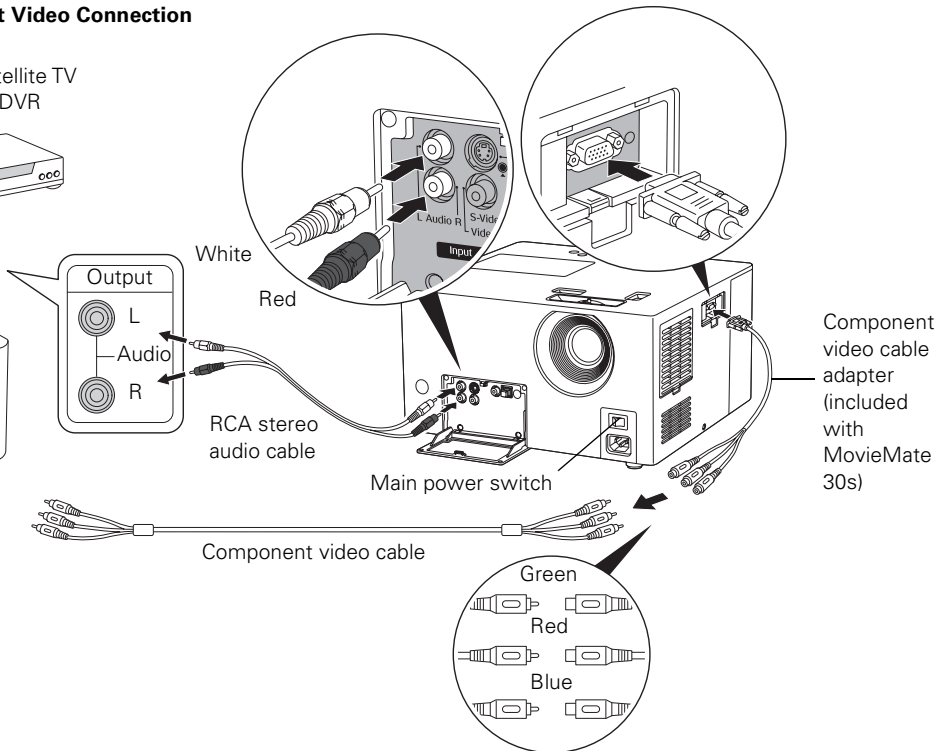

Game console



2. Connect the power cords and plug in all the equipment.
3. Turn on MovieMate's main power switch.
4. Press the  **Power** button on MovieMate or on the remote control.
5. Press the  button on MovieMate or on the remote control to select **Video**.
6. Turn on the power to the connected video equipment, then start playing the video.
7. To enlarge or reduce the aspect ratio of the picture, press the  button on the remote control to select **Normal**, **Wide**, or **Zoom** (if available for the video source you're using). (Make sure the toggle switch on the remote control is set to the **Func.-** position.)

Note: After you disconnect your external equipment, make sure you close MovieMate's port compartment covers.

Using the Optional Subwoofer

You can connect the optional 40 W subwoofer to provide rich, deep bass sound for your movies, games, and other presentations with audio.

1. Connect the RCA audio cable that came with the optional subwoofer as shown below. See the instructions included with the subwoofer for more information.

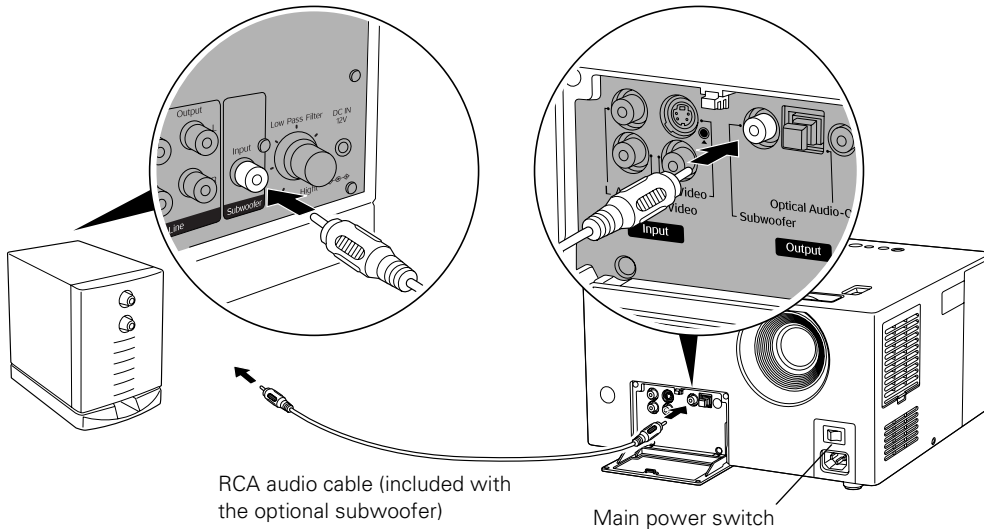

2. Plug in the subwoofer.
3. Turn on the power switches on the subwoofer and on MovieMate.
4. Turn the speaker side of the subwoofer toward your listeners for the best sound.
5. Play your movie, game, or other presentation.
6. To adjust the volume and bass tones from the subwoofer, turn it's volume control and crossover knobs. See the instructions included with the subwoofer for more information. You can also adjust the volume using MovieMate's control panel or remote control, and use any of MovieMate's other audio controls, as described on pages 42 through 43.

Playing Audio From a Digital Audio Device

You can use MovieMate to provide speakers for a digital audio device, such as an iPod, MP3 player, portable CD player, or other device.

1. Make sure your audio equipment is turned off.
2. Connect an RCA stereo audio cable to your audio device and to MovieMate as shown below.

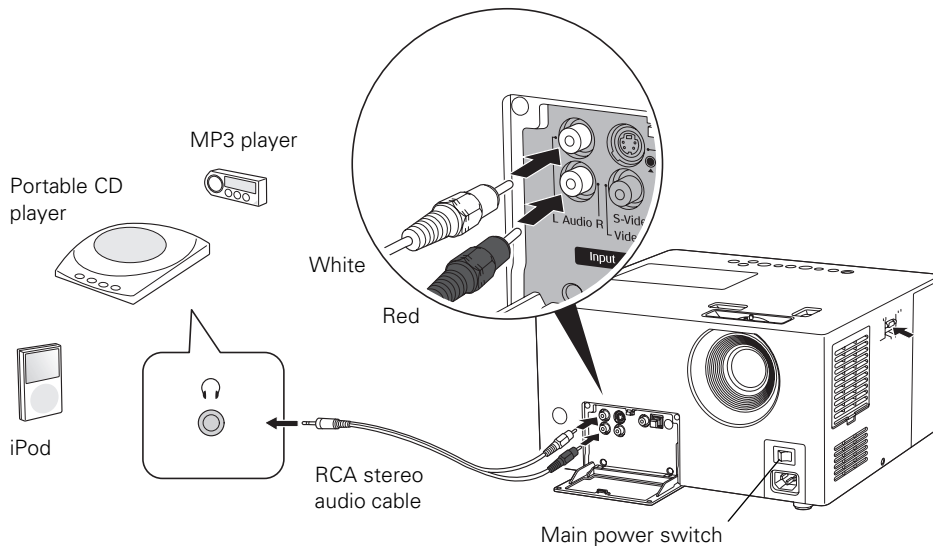

3. Turn on the power switches on MovieMate and your audio equipment, and play your music using the device controls.
4. You can adjust the volume input level by pressing and holding the ^{DVD Level} **+10** button for approximately 2 seconds. **LEVEL 1** appears on MovieMate's display window. Press and hold the button again to select **LEVEL 2** and increase the volume. You can also use any of MovieMate's other audio controls, as described on pages 42 through 43.

Playing MovieMate Audio Through an External Audio System

You can connect MovieMate to an audio receiver, 5.1 Stereo Surround Sound System, or digital audio recorder. To output sound from MovieMate, the external equipment needs to have an optical audio input port.

Note: For additional convenience, Epson has developed an optional Wireless 5.1 Surround Sound System adapter for the MovieMate 30s Series. To find out more about this accessory, go to www.epson.com/homeentertainment.

You will also need an optical digital cable, which may be provided with your external equipment, or may be purchased from an electronics store.

1. Remove the protective cap from the **Optical Audio-Out** port and keep it in a safe place.
2. Make sure the equipment is turned off, then connect the cable as shown:

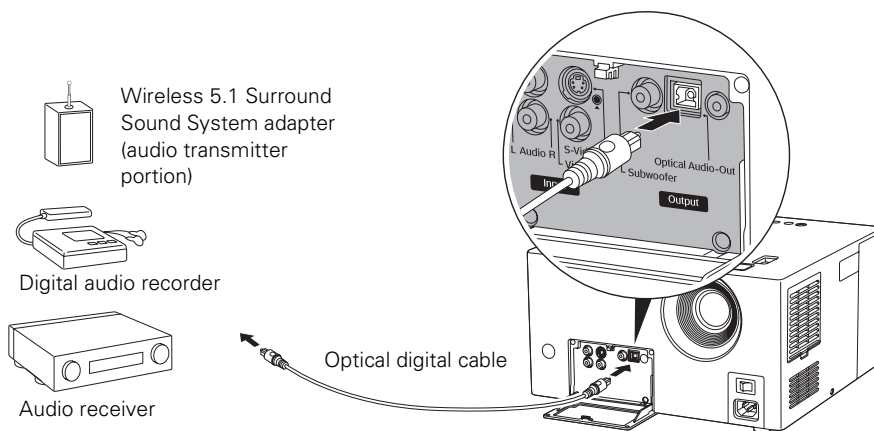

3. Turn on your audio equipment and play your movie, music, or other presentation with sound from MovieMate.
4. You can adjust the volume input level by pressing and holding the ^{DVD Level} **+10** button for approximately 2 seconds. **LEVEL 1** appears on MovieMate's display window. Press and hold the button again to select **LEVEL 2** and increase the volume.

You may also need to change the **Digital Audio Output** or **Downmix** settings in the **Audio Setup** menu. Make sure you use the **Stream/PCM** setting for surround sound systems. You can also use any of MovieMate's other audio controls, as described on pages 42 through 43.

Note: After you disconnect your external audio equipment, make sure you replace the cap on the Optical Audio Out port and close MovieMate's port compartment cover.



Connecting a Computer or Laptop

You can connect MovieMate to a computer or laptop to play videos or games, display presentations or photos, or project anything you can see and hear on your computer.

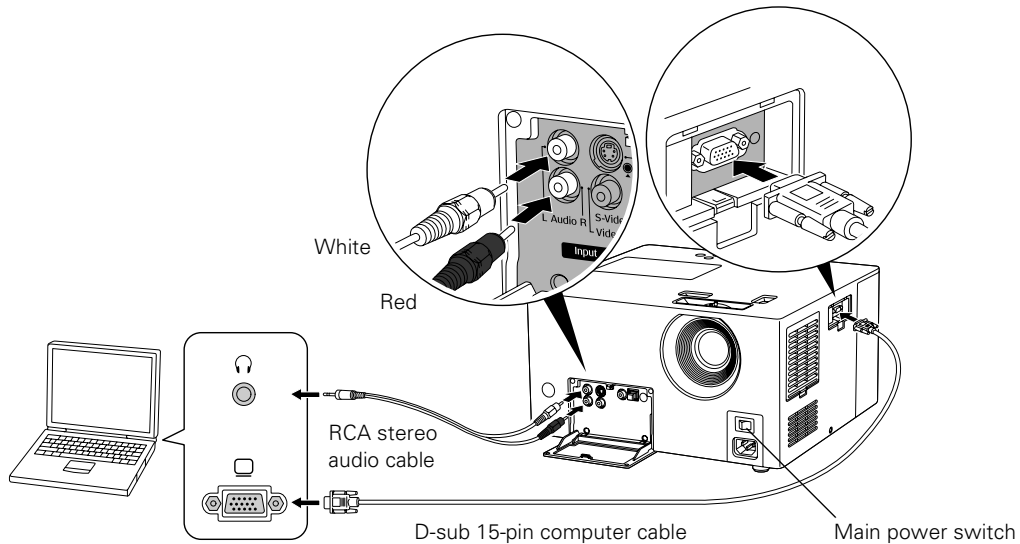

Caution: Before connecting, make sure all equipment is turned off.

1. Connect the computer or laptop as shown.



2. Connect the power cords and plug in all the equipment.
3. Turn on MovieMate's main power switch.
4. Press the  **Power** button on MovieMate or on the remote control.
5. Press the  button on MovieMate or on the remote control to select **Computer**.
6. Turn on the power to the connected computer or laptop.
7. Switch the display on the computer or laptop to display on MovieMate, or on both MovieMate and the computer screen. Usually you do this by pressing function keys to toggle through display choices; see your computer documentation for instructions.

Note: If your laptop cannot play movies on both the laptop display and its video out port, you may need to disable the laptop display to view movies on MovieMate. See your laptop documentation for instructions.

8. If the image flickers, you may need to synchronize the signal, especially if you have connected different computers to MovieMate in the past. Press the  auto setup button on the remote control to correct this problem.
9. To enlarge or reduce the aspect ratio of the picture, press the  button on the remote control to select **Normal**, **Wide**, or **Zoom** (if available for the video source you're using).

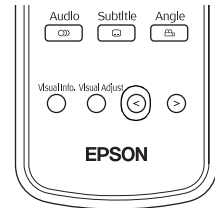

Note: After you disconnect your external equipment, make sure you close MovieMate's port compartment covers.

Wall and Projection Screen Recommendations

To optimize viewing of MovieMate images on a wall in your home or on an optional projection screen, follow the recommendations in this section.

Viewing on a Wall

You can easily view MovieMate's high quality images on any flat white wall in your home. There is no cost or setup involved, and you can project and resize the image up to any size that fits on your wall. To enhance the image quality even further, you may want to paint the wall with projection paint that is specially designed for optimum reflectivity and contrast in your viewing environment.

Viewing on a Projection Screen

If you don't have a suitable wall in your home or want a professional quality viewing experience, you can use a projection screen. These screens have optical coatings with special reflective properties that enhance brightness, contrast, and sharpness as well as providing a frame around the image.

Projection screens are available in many shapes, sizes, mounting styles, colors, and surface qualities, as described below.

Considering Screen Shape and Size

In a home theater setting—for watching DVD movies, HDTV broadcasts, or other widescreen content—the best screen shape ratio is 16:9, where the width is almost twice the height. Most DVD movies and HDTV broadcasts will fill the screen vertically and horizontally for maximum impact. The most popular sizes are from 45 to 100 inches diagonal.

Standard screens have a 4:3 shape ratio, which is better suited for viewing computer presentations and standard TV broadcasts. Watching DVD movies or HDTV broadcasts on a 4:3 ratio screen limits the image width and leaves black bars above and below the image. Available screen sizes vary, but are usually up to 60 inches diagonal (the same height as an 80-inch diagonal 16:9 screen).

Screens are also available for wider image formats, such as CinemaScope™ (approximately 2.35:1), but are not as common.

Considering Screen Mounting Style

Most screens are either floor standing, wall mounted, or ceiling mounted. Consider these characteristics as you choose which type would be best for your viewing environment:

Screen mounting style	Characteristics
Floor standing screens	Portable Can be used in multiple locations Can be stored out of the way Some may also be wall mountable
Wall mounted screens	Typically permanently installed Can be partially hidden out of the way Some may be disguised as artwork
Ceiling mounted screens	Typically permanently installed Can be partially hidden out of the way Some may be recessed into the ceiling and hidden completely Can be manually or electronically dropped and raised
Outdoor screens	Resistant to outdoor environmental factors Can be used on patios, and around pools and landscaping Usually made of inflatable plastic or vinyl

Considering Color and Surface Quality

For home theater settings, screens come in white or a shade of gray. Gray screens (sometimes called high contrast screens) increase the natural contrast of images projected in rooms with ambient light by absorbing the room light and preserving the darker blacks. If you have a dedicated home theater room with dark walls, ceiling, floor, and furniture, a gray screen may not provide better contrast than a white screen. However, if you usually project images in a typical living room or family room with some reflected light, a gray screen will provide better contrast and a truer viewing experience.

Screen surface quality can also affect the reflectivity of light in your projected image. Screen reflective properties are measured as “gain” rates, with 1.0 gain as the reflectivity of a white board. Highly reflective screen surfaces (above 1.0 gain) create a brighter image, but the brightness may not be uniform enough for a dedicated home theater environment and the colors may appear to shift from different viewing angles. In a home theater room with darkened surroundings and controlled lighting, a screen surface with less than 1.0 gain is best. For rooms where you cannot control the light or will always have ambient light, you may want to select a screen surface with more than 1.0 gain to compensate for the additional brightness.



Doing More with MovieMate

Follow the instructions in this section to play music and photos on MovieMate, use advanced playback controls, and adjust various MovieMate features.



Playing Music and Displaying Photos

You can play music CDs and CDs with MP3 or WMA files. You can also view JPEG photos on CDs.

Playing Music CDs

- To play a music CD, insert it in the tray, then press  on MovieMate's control panel or  on the remote control.

You can use most of the video playback features, including pause, resume, fast forward, reverse, and skip to the next or previous track.

- You can also select a specific track by using the numeric buttons, as described on page 20. To use the numeric buttons, you need to set the toggle switch on the remote control to the -123 position.
- To turn off the lamp when playing music, press . Press  to turn the lamp back on again.

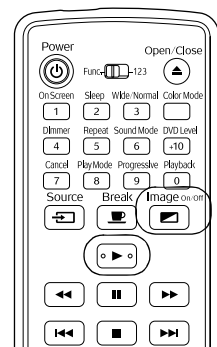







Note: When you play music CDs, the lamp usually turns off automatically.

Playing MP3/WMA Music and JPEG Photo Files on Disc



You can play MP3 or WMA music files and JPEG photo files on CDs or DVDs. See page 63 for information on the types of discs that are supported.

When you insert a disc that contains MP3, WMA, and/or JPEG files, an on-screen menu like this is displayed:

FILE	PROGRAM REPEAT TRACK TIME --:--:-- ▶
Group : XX / XXX	Track :XXXX/XXXX (Total XXXX)
Group A	5. Track 5
Group B	6. Track 6
Group C	7. Track 7
Group D	8. Track 8
Group E	9. Track 9
Track Information	10. Track 10
Title	11. Track 11
XXXXXXXXXXXXXXXX	12. Track 12
Artist	13. Track 13
XXXXXXXXXXXXXXXX	14. Track 14
Album	15. Track 15
XXXXXXXXXXXXXXXX	16. Track 16

1. Press  to select the group.
2. Press  to move the pointer to the track (file name) list.
Press  to return the pointer to the group name list.
3. Press  to select the track.
4. Press  or  to begin playing the selected track or file.

When a file is finished playing, the next file in the sequence will start automatically.

For JPEG files, press  to begin playing a slideshow of all the photos, or press  to display individual photos.

- To turn off the lamp when playing music files, press .

To turn the lamp back on, press  again.

- You can select program or random play following the instructions on page 36.
- When you play MP3 or WMA files, scrolling through the list of songs will pause the music until you highlight the next file.

Note: If your disc includes both music and photo files, use the Picture Setup menu to specify the type of files you want to play. See page 44 for instructions.

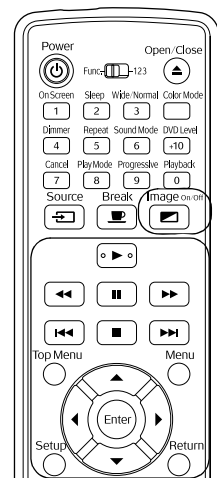



Using Advanced Playback Controls

MovieMate 30s provides advanced features for looping videos or music tracks and selecting titles, chapters, or tracks. On DVDs that include subtitles, multiple languages, or multiple camera angles, you can use remote control for easy access to these features.



Repeating a Chapter, Title, or Track

You can select a chapter or title on a DVD to repeat continuously (or loop). You can also loop a track on a music CD.

1. To repeat a chapter, title, or track, press . You see an icon on the screen: .
2. Press  again to cycle through the options for repeating.

On a video DVD, you can repeat a chapter or title.

On a music CD, you can repeat one track, a group of tracks, or all tracks.









3. To cancel repeat play, press  until  is displayed on the screen.

Repeating a Scene

You can use the on-screen menu to set the start and end point for continuously repeating a particular scene in a video (A-B repeat).

1. Press  twice. The on-screen menu is displayed:



2. Press  until  is highlighted, then press .
 3. Press  and select .
- Note:** You can also select other repeat modes from this menu. See the previous section for more information.
4. When you reach the point in the scene or track where you want to start, press .
 5. When you reach the point in the scene or track where you want to stop, press  again.
 6. Press  to cancel the on-screen menu. The scene begins playing from the location you specified.

To cancel the repeating scene, press . This also stops the video.

Changing the Play Sequence (Program Play)

You can create your own program for playing tracks on a music CD or chapters and titles on a DVD.

1. When the CD or DVD is stopped, press ^{PlayMode} **8** until you see **PRGM** in the display window.
 2. Set the toggle switch on the remote control to the **-123** position.
 3. Use the numeric buttons to set the program order (up to 99 chapters, titles, or tracks).
 4. Press **▶** to begin playing your programmed sequence.
 5. Set the toggle switch on the remote control back to the **Func.-** position.
- To cancel individual items on the program screen, press ^{Cancel} **7**.
 - To cancel the program, press **■**.
 - To resume normal playback, press ^{PlayMode} **8** repeatedly until the display window returns to normal. The program remains in memory, and you can play it again by pressing ^{PlayMode} **8** again and selecting **PRGM**.

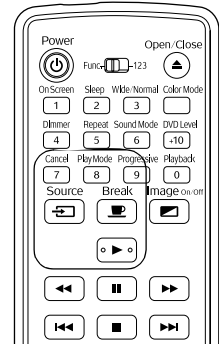

Playing at Random

You can select random play for tracks on a music CD or chapters and titles on a DVD.





1. When the CD or DVD is stopped, press ^{PlayMode} **8** repeatedly until you see **RANDOM** in the display window.
2. Press **▶** to begin playing tracks at random.

To resume normal playback, press ^{PlayMode} **8** repeatedly until the display window returns to normal.

Random play is also canceled when you open the tray or switch off the power.

Selecting Language, Subtitles, and Camera Angles

Some DVDs allow you to display subtitles or select from several languages or camera angles. If these features are available, you can use the buttons on the remote control to select them.

1. Press the appropriate button on the remote control:
 - To change the language of the video, press .
 - To display subtitles, press . You may have a choice of subtitle languages.
 - To change camera angles, press .
2. Press the button repeatedly to display the options available.
3. Press  to select the setting you want. Wait a few seconds or press .

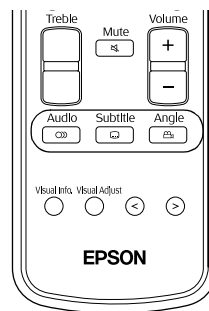

Note: You can also use the Language Setup menu, as described on page 41. For a list of language codes, see page 67.











Searching for a Specific Time

You can search for a specific time to begin playing a video (from the start of the title), or from the beginning of a music CD. After you start playing a music CD, you can search from the start of the current track.

Note: This feature may not be available on all DVDs or CDs.

1. Press  twice. The on-screen menu is displayed:



2. Press  until  is highlighted, then press .
3. Set the toggle switch on the remote control to the -123 position.
4. Enter the time using the numeric buttons.
 - For DVD videos, enter the time in hours, minutes, and seconds. For example, to play a video from 0 hours, 23 minutes, and 45 seconds, press the numeric buttons in this order: , , , , . If you make a mistake, press  to delete it, then enter the correct number.
 - For music CDs, enter the time in minutes and seconds.
5. Press .



6. Set the toggle switch on the remote control back to the Func.- position.

To cancel the on-screen menu, press ^{OnScreen} . The video or CD begins playing from the location you specified.

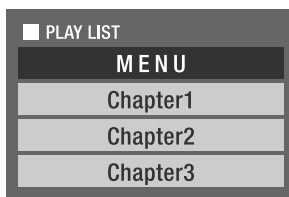

Playing Video CDs with Playback Control (PBC)





When you insert a video CD with playback control (PBC), you see a menu like the following:



- To select the item you want to play, set the toggle switch on the remote control to the -123 position, then use the numeric buttons as described on page 37.
- To display the next or previous menu page, press  or  when the menu is displayed.
- To open the menu during playback, press ^{Return}  repeatedly until the menu is displayed.
- To play without using the menu (play without PBC):

When the video is stopped, specify the track number that you want to see using the numeric buttons.

When the video is stopped, select the track number using  or  then press .

- To open the menu screen when playing back without PBC, press ^{Top Menu}  or ^{Menu} . Press  twice to stop playback, then press .

Customizing MovieMate

You can limit children's access, improve the sound, adjust the picture, and customize other features of MovieMate. Many of these settings are available through the Setup menus, which you can access by pressing the Setup button on the remote control (when a DVD is not playing).

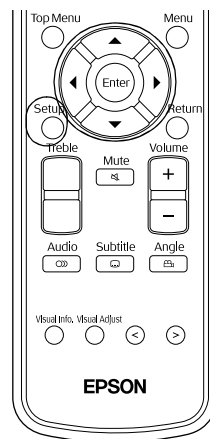







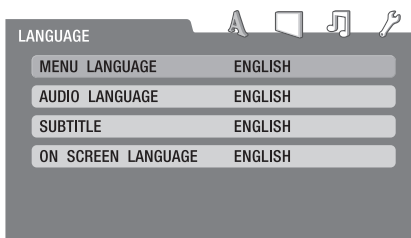

Setting Parental Controls

You can set parental controls to prevent children from viewing inappropriate video material.

1. When a DVD is not playing, press the  button on the remote control. You see the **LANGUAGE** Setup menu:



2. Press  to highlight  and display the **OTHERS** Setup menu.
3. Press  to highlight **Parental Lock**, then press  to select it.
4. Press  to highlight one of the settings, then press  to view your options.
5. Press  to select the option you want, then press  to save it.

To return to the previous menu level, press .

You can select from the following options for Parental Lock:







- **COUNTRY CODE:** Select **US**.
- **SET LEVEL:** The smaller the number, the greater the restriction. If you want to disable Parental Lock, select **NONE**.
- **PASSWORD:** Set the toggle switch on the remote control to the **-123** position, then enter a 4-digit number using the numeric buttons. Press  to save the password.

Once a password is set, you will need to enter it before you can change the Parental Lock settings. If the wrong password is entered three times, the menu closes. If you forget your password, enter **8888**.

Locking the Power Button on the Control Panel





You can lock the  Power button on the control panel to prevent young children from accidentally turning on MovieMate and looking into the lens. (You can still turn on MovieMate using the remote control, so you may want to place it out of children's reach.)

Warning: Do not allow young children to look into the projector lens when MovieMate is turned on. The lens projects bright light that may affect their vision.

- To lock the  Power button, press and hold the  button, then press and hold the  button on the control panel. **CHILD LOCK** appears briefly in the display window above the tray. Then turn off MovieMate.
- To turn MovieMate on, press and hold the  Power button on the control panel for five seconds or use the remote control.
- To unlock the  Power button on the control panel, press and hold  and  again. **UNLOCKED** appears briefly in the display window.

Locking the Tray

You can lock the tray to prevent children from playing with it.

- To lock the tray, press and hold the  button on the MovieMate control panel, then press . **TRAY LOCK** appears briefly in the display window above the tray.
- To unlock the tray, press  and  again. **UNLOCKED** appears briefly in the display window.

Saving Power

You can select several settings that turn off the power automatically when MovieMate is not playing a disc. Power saving settings are not saved after you turn off MovieMate.

To select a power-saving option, press . Continue pressing the button to select from the following settings:

- **A. STBY ON:** The power switches off automatically after 3 minutes (Auto Standby).
- **SLEEP 10:** The power switches off automatically after 10 minutes. You can select Sleep Timer settings up to 150 minutes.
- **SLEEP OFF:** Power saving is disabled.

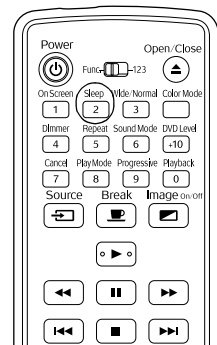





Changing Language Settings

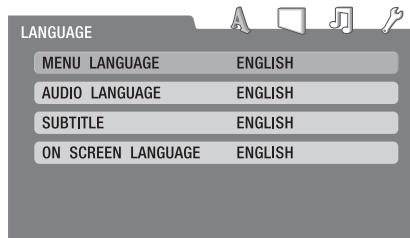







You can use the Language Setup menu to change the default language for DVDs that allow you to make this selection.

1. When a DVD is not playing, press the  button on the remote control. You see the LANGUAGE Setup menu:



2. Press  to highlight the setting you want, then press  to display a list of languages.
3. Press  to select the language you want, then press  to save it. For a list of language code definitions, see page 67.
4. To return to the previous menu level, press .

Adjusting the Resume and On-Screen Guide Settings

1. When a DVD is not playing, press the  button on the remote control.
2. Press  to highlight  and display the OTHERS Setup menu.
3. Press  to highlight RESUME or ON SCREEN GUIDE, then press  to display the ON/OFF selection box.
4. Press  to select the setting you want, then press  to save it.
 - **RESUME:** This setting defines the way playback resumes after pausing. To have playback resume from the point where it was stopped, set to ON (the default). To have playback start from the beginning of the chapter, set to OFF.
 - **ON SCREEN GUIDE:** This setting, which is ON by default, briefly displays an indicator on the screen when you pause, resume, or use other playback controls. Select OFF if you don't want these indicators to be displayed.
5. To return to the previous menu level, press .

Adjusting General Audio Settings

MovieMate provides several settings for adjusting the audio quality and volume.

- To adjust the treble, use the **Treble** buttons on the remote control.
- To adjust the sound mode, press ^{Sound Mode} **6**. Continue pressing the button to select the JVC original sound system setting that you prefer:
 - NATURAL**: Produces a broader, more natural sound.
 - SMOOTH**: Produces a sound that is more pleasant to the ear.
 - OFF**: Disables the JVC original sound system (default).
- To adjust the bass, you can use the crossover knob on the back of the optional subwoofer.

To adjust detailed settings, use the **Audio Setup** menu as described below.

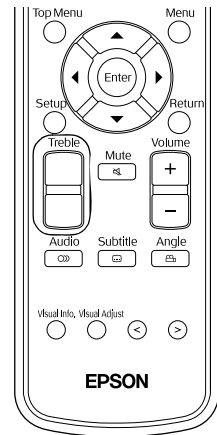

Adjusting DVD Movie Sound Levels

The default sound setting plays DVD movies at a higher volume than other discs. You can adjust this setting if necessary.

To adjust the DVD movie sound level overall, press ^{DVD Level} **+10**. Continue pressing the button to select the level you prefer: DVD LEVEL 1, DVD LEVEL 2, or DVD LEVEL 3 (the highest volume and default setting).



To adjust detailed settings, use the **Audio Setup** menu as described below.

Adjusting Detailed Audio Settings

To adjust detailed audio settings in the **Audio Setup** menu, follow these steps:

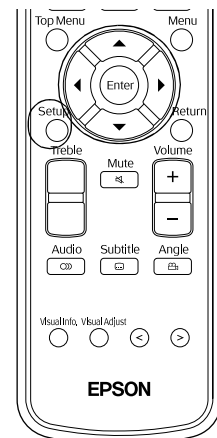
1. Press the ^{Setup} **Setup** button on the remote control.
2. Press **Audio** to highlight  and display the **AUDIO** Setup menu.
3. Press **Enter** to highlight the setting you want, then press **Enter** to display the options.



4. Press  to select the option you want, then press  to save it. You can choose from the following:
 - **DIGITAL AUDIO OUTPUT:** Select the appropriate setting when you use external audio equipment connected to the Optical Audio-Out port.

STREAM/PCM: For a DTS/Dolby Digital Decoder or surround sound system (default setting).

PCM ONLY: For equipment that is only compliant with Linear PCM (Pulse Coded Modulation).

DOLBY DIGITAL/PCM: For a Dolby Digital Decoder or similar equipment.
 - **DOWN MIX:** Select the signal from the Optical Audio-Out port, built-in speakers, and headphone jack.

DOLBY SURROUND: For connecting to equipment with a built-in Dolby Pro-Logic decoder or using the built-in speakers or headphones (default setting).





STEREO: For connecting to standard equipment.
 - **D. RANGE COMPRESSION:** Select the appropriate setting for the best DVD volume control.



ON: Dynamic range compression is on at all times (default setting).

AUTO: Dynamic range compression is selected automatically.
5. To return to the previous menu level, press .

Adjusting Picture Settings

The **Picture Setup** menu lets you select settings for your video source, screensaver, and MP3/WMA/JPEG files.

1. Press the  button on the remote control.
2. Press  to highlight  and display the **PICTURE Setup** menu.
3. Press  to highlight the setting you want, then press  to display the options.

4. Press  to select the option you want, then press  to save it. You can choose from the following:

■ **PICTURE SOURCE**

AUTO: The image source (video/film) is determined automatically (default setting, recommended for most purposes).

FILM: For film or video recorded with progressive scan.

VIDEO: For video images without progressive scan, for example, camcorder input.

- **SCREEN SAVER:** Select whether to fade out a projected still image after 5 minutes of inactivity.

- **FILE TYPE:** Select the file format to display when you insert a disc that includes both MP3/WMA (**AUDIO**) and JPEG (**STILL PICTURE**) files.

5. To return to the previous menu level, press .

Adjusting Picture Quality

You can use the **Visual Adjust** button on the remote control to adjust the brightness, contrast, color saturation, tint, and sharpness of the image. If MovieMate is tilted up or down, you can also use this button to correct the non-rectangular “keystone” shape of the image.

1. Press the  button on the remote control. You see the following on the screen:





2. Press the  button until you see the item you want to set.

You can adjust the following items for various viewing conditions and individual videos:

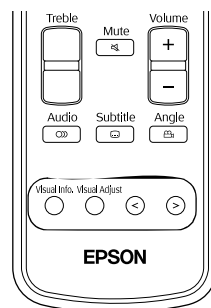
- **Brightness**
- **Contrast**
- **Color Saturation**
- **Tint** (only works on NTSC signals)
- **Sharpness**
- **Keystone:** Corrects the distorted image shape caused by tilting MovieMate up or down, as shown.



3. Press  or  to increase or decrease the setting.

The settings are saved, even after you turn MovieMate off.

Viewing and Adjusting Video Information

You can use the **Visual Info.** button on the remote control to view the number of hours the lamp has been used, and to reset the timer after you install a new lamp. You can also adjust the video signal setting and select high altitude mode if necessary.

1. Press the  button on the remote control. You see the following on the screen:

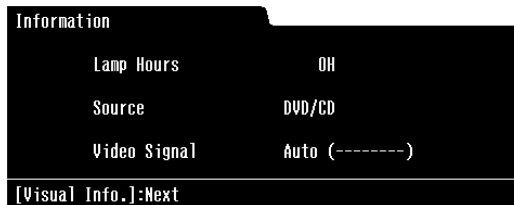



Note: If the lamp has been used less than 11 hours, 0H is displayed.

2. Continue pressing the  button until you see the item you want to set.

You can adjust the following items:

- **Video Signal:** If you are using external video equipment and you see interference or other problems, select the appropriate signal for your equipment. For most purposes, leave this setting on **Auto**.
- **High Altitude Mode:** If you are using MovieMate at an altitude above 4,900 feet (1500 meters), select **ON**.
- **Lamp-Hours Reset:** After you replace the lamp, select **Yes** to reset the lamp timer.

3. Press  or  to change the setting.
4. Press the  button to save your settings and exit.

Disabling Progressive Mode

For the best image quality, MovieMate uses progressive video display mode. You can change to interlaced mode if the picture appears jittery, for example, when you use certain external equipment.

To change from progressive to interlaced display mode, press  .

Changing the Display Window Brightness

The status display window above the tray is normally dimmer when a DVD is playing and brighter when it is paused or stopped.

To change the display window setting, press . Continue pressing the button to select from the following settings:

- **DIMMER OFF:** The window remains bright, even when a DVD is playing.
- **DIMMER ON:** The window remains dim, even when a DVD is not playing.
- **DIMMER AUTO:** The window is dimmer when a DVD is playing and brighter when it is paused or stopped.

Caring for MovieMate

MovieMate 30s needs little maintenance. All you need to do on a regular basis is keep the lens clean. You also need to clean the air filter periodically to prevent overheating.

Warning: Before you clean any part of MovieMate, turn it off and unplug the power cord. Never open any part of MovieMate, except as described in this *User's Guide*. Dangerous electrical voltages in the projector can injure you severely. Do not try to service this product yourself, except as specifically explained in this *User's Guide*.

The only parts you should replace are the lamp and air filter. If another part needs replacing, contact Epson or a qualified servicer (see page 62).

Follow the instructions in this section to clean the lens and case, clean and replace the air filter, replace the lamp, and store or transport MovieMate.

Protecting MovieMate

The Epson MovieMate projector is designed for use virtually anywhere at home. However, MovieMate and its accessories should not be exposed to water, smoke, direct heat or sunlight, or left outside for long periods of time. As with typical electronic equipment, please avoid exposure of MovieMate to moisture, dust, smoke, and other environmental factors which may result in damage to internal electronics over time. See the “Epson America, Inc. Limited Warranty” on page 71 for additional details on the use of your MovieMate 30s Series.

Cleaning the Lens

Clean the lens whenever you notice dirt or dust on the surface.

- Use a canister of compressed air to remove dust.
- To remove dirt or smears, use lens-cleaning paper. If necessary, moisten a soft cloth with lens cleaner and gently wipe the lens surface.

Caution: Never rub the lens with abrasive materials.

Cleaning MovieMate's Case

Before you clean the case, turn off MovieMate and unplug the power cord.

- To remove dirt or dust, wipe the case with a soft, dry, lint-free cloth.
- To remove stubborn dirt or stains, moisten a soft cloth with water and a neutral detergent. Wring the cloth as dry as possible, then wipe the case.

Caution: Never use wax, alcohol, benzene, thinner, or other chemical detergents. These can damage the case. Never spray cleaners directly on MovieMate.

Cleaning and Replacing the Air Filter

Clean the air filters when dust builds up or when you see the following message:

The projector is overheating. Make sure nothing is blocking the air vents, and clean or replace the air filter.

If the air filters are not cleaned periodically, they can become clogged with dust, preventing proper ventilation. This can cause overheating and damage MovieMate.

1. Turn off the main power switch and unplug MovieMate.
2. Use a small vacuum cleaner designed for computers and other office equipment to clean the filters, as shown.

If you cannot clean the removable filter or it is broken, you need to replace it.

You can purchase a new filter (part # V13H134A09) from an Epson authorized reseller. To find the nearest reseller, call 800-GO-EPSON (800-463-7766). Or you can purchase online at www.epsonstore.com (U.S. sales) or www.epson.ca (Canadian sales).

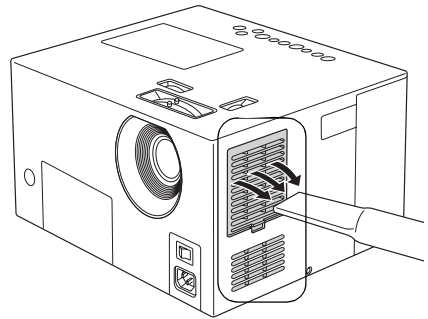

3. If you need to replace the filter, press up on the tab and lift off the cover.

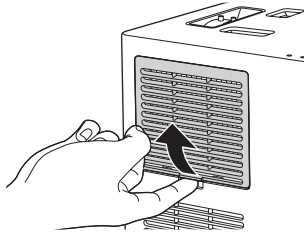

4. Remove the old filter and install the new filter.

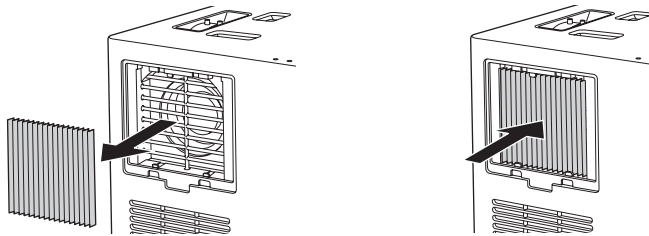

5. Replace the cover.

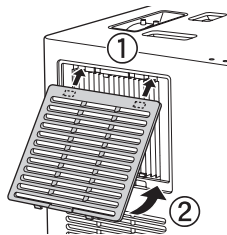

Replacing the Lamp

The life span of the lamp is about 3000 hours if the color mode is consistently set to **Theatre Black**, and 2000 hours if any other color mode is used. (For instructions on changing the color mode, see page 20.)

You can check how long the lamp has been used as described on page 45. If the number shown is close to the limit, make sure you have a spare lamp handy.

Note: Turn off this product when not in use to prolong the life of the projector.

It's time to replace the lamp when:

- The projected image gets darker or starts to deteriorate.
- The lamp status light flashes orange.
- The message **Replace the lamp** appears on the screen when you start projecting.

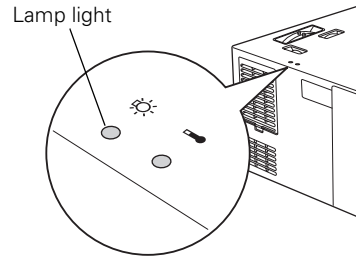

Caution: If you continue to use the lamp after you see the replacement indicators, the lamp is more likely to break.

You can purchase a new lamp (part # V13H010L33) from an Epson authorized reseller. To find the nearest reseller, call 800-GO-EPSON (800-463-7766). Or you can purchase online at www.epsonstore.com (U.S. sales) or www.epson.ca (Canadian sales).

Be sure to read the “Important Safety Information” on page 68 before replacing the lamp.

Follow these steps to replace the lamp:

1. Turn off the main power switch and disconnect the power cord.
2. If the projector has been on, let it cool for at least an hour.

Warning: Let the lamp cool before replacing it. If the lamp breaks, handle the shards carefully to avoid injury.

3. Insert a small screwdriver into the lamp cover release slot, pushing it in gently to release the lamp cover.

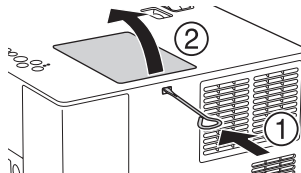

4. Loosen the two silver screws holding the lamp in place. (You can't remove these screws.)

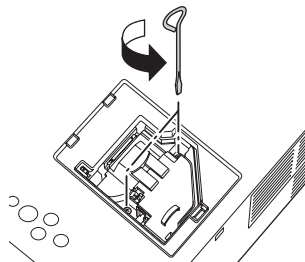

5. Grasp the lamp as shown and pull it straight out.

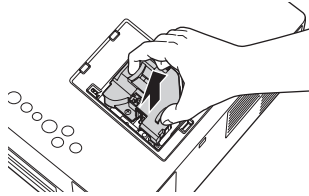

Note: (Hg) The lamp in this product contains mercury. Please consult your state and local regulations regarding disposal or recycling. Do not put in the trash.

6. Gently insert the new lamp and tighten its screws.

Caution: Don't touch the glass portion of the lamp with your bare hands; the invisible residue left by the oil on your hands may shorten the lamp life. Use a cloth or gloves to handle the new lamp assembly.

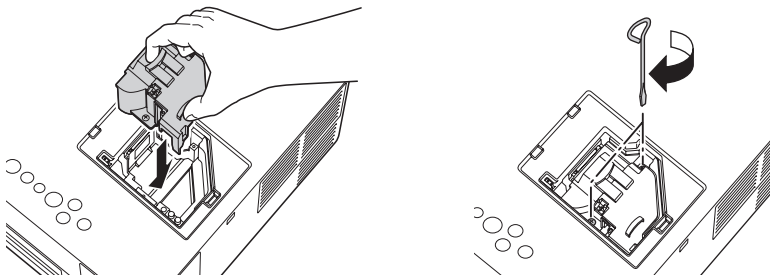

7. To replace the lamp cover, insert the tabs and then snap the cover into place. (MovieMate won't work if the lamp cover is loose.)

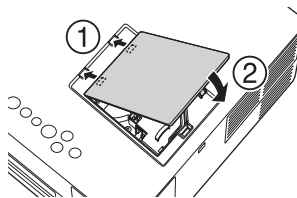

8. After replacing the lamp, you need to reset the lamp timer, as described in the next section.

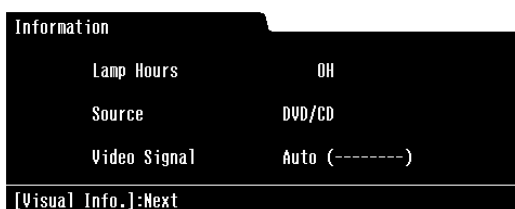

Resetting the Lamp Timer

1. Press the ^{Visual Info.}  button on the remote control. You see the following on the screen:

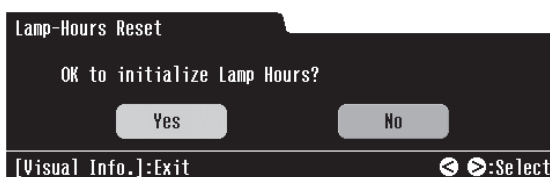

2. To reset the lamp timer, continue pressing the ^{Visual Info.}  button until you see this display:



3. Press  or  to select Yes.
4. Press the ^{Visual Info.}  button to reset the timer.

The lamp usage timer displays 0H (zero hours) until you've used the lamp for at least 10 hours.

Storing MovieMate

Follow these guidelines when storing MovieMate:

- Make sure the temperature and humidity of the storage area are within the recommended range for the projector: 14 to 140 °F (–10 to 60 °C) and 10 to 90% relative humidity without condensation.
- Attach the lens cover.
- Remove the batteries from the remote control.
- Package MovieMate in its original packaging or equivalent (as described in the following section).

Transporting MovieMate

Note: Epson shall not be liable for any damages incurred during transportation.

MovieMate contains many glass and precision parts. If you need to transport it, follow these guidelines to prevent damage:

- When shipping MovieMate for repairs, use the original packaging material if possible. If you do not have the original packaging, use equivalent materials, placing plenty of cushioning around MovieMate. Be sure the carrier is capable of transporting fragile equipment and is aware that MovieMate is fragile. Remove the lens cover and wrap it separately.
- If you move MovieMate from a cold environment into a warm room, condensation (moisture) may form internally or on the lens surface. To avoid damage that might be caused by condensation, wait approximately an hour before using MovieMate. If condensation forms, turn on the main power switch, then wait an hour or two before use.
- When you are hand-carrying MovieMate, remove all discs, close the tray, and make sure the lens cover is securely in place. To avoid damaging the mesh covering the speakers, lift MovieMate as shown below:

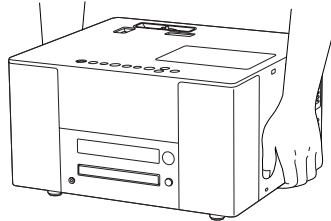

Problem Solving

This section explains how to interpret MovieMate's status lights, solve problems, and contact technical support.

What To Do When the Lights Flash

The lights on top of MovieMate indicate its status and let you know when a problem occurs.

If all lights are off, make sure the power cable is connected correctly and the main power switch is turned on.

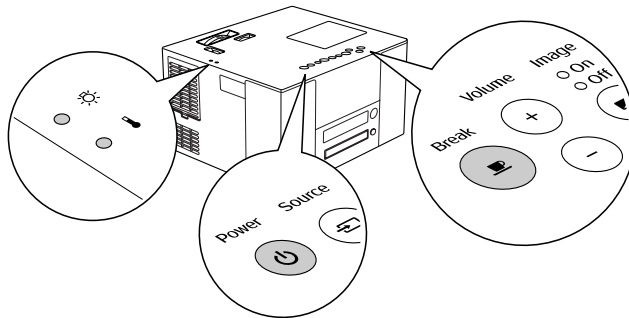

The Image Off light is orange.

MovieMate is in sleep mode. Press the  Power button to turn it on.

The Image On light is flashing green.

MovieMate is warming up. Wait for the picture to appear.

The Image Off light is flashing orange.

MovieMate is cooling down. Wait until the light stops flashing, then turn off the main power switch (to turn off MovieMate) or press the  Power button (to turn on MovieMate).

The  button is flashing green.

Press the  button to return to normal operation.

The 🔥 warning light is flashing orange.

High-speed cooling is in process. If MovieMate gets too hot again, projection stops automatically. Make sure MovieMate is at least 8 inches away from the wall.

Clean or replace the air filters if necessary (see page 48). If you are using MovieMate at an altitude above 4,900 feet (1500 meters), turn on High Altitude Mode (see page 45).

The 🔧 warning light is flashing orange or red.

The lamp needs to be replaced. See page 49.

The ⏻ Power button is flashing orange and green and the 🔥 warning light is red.

MovieMate is too hot and has turned off the lamp. Make sure MovieMate is at least 8 inches away from the wall.

Clean or replace the air filters if necessary (see page 48). If you are using MovieMate at an altitude above 4,900 feet (1500 meters), turn on High Altitude Mode (see page 45).

Let MovieMate cool for five minutes, then turn it back on. If the status doesn't change, unplug MovieMate and contact Epson. See page 62.

The ⏻ Power button is flashing orange and green and the 🔧 warning light is flashing red.

The lamp may be incorrectly installed, the lamp cover may be loose, or the lamp may be broken. Turn off the power and check the lamp. See page 51. If the lamp is broken, or the lights continue to flash after you turn the power back on, unplug MovieMate and contact Epson. See page 62.

The ⏻ Power button is flashing orange and green and the 🔥 warning light is flashing red.



MovieMate has a problem with its fan or temperature sensor. Unplug MovieMate and contact Epson. See page 62.

The ⏻ Power button is flashing orange and green and both 🔧 🔥 warning lights are flashing red.

MovieMate may have an internal error. Turn off the power, then turn it back on. If the lights continue to flash, unplug MovieMate and contact Epson. See page 62.

Solving MovieMate Operation Problems

MovieMate doesn't turn on.



- Make sure the main power switch is turned on.
- If the Image On light is flashing green, MovieMate is warming up. Wait for the picture to appear.
- If the Image Off light is flashing orange, MovieMate is cooling down. Wait until the light stops flashing, then press the  Power button to turn on MovieMate.
- If the  Power light is green and not flashing, MovieMate is operating normally. Make sure the lens cover is off. Press the  button on MovieMate or on the remote control to make sure the picture hasn't been turned off temporarily.
- Turn off the main power switch and make sure the power cord is securely attached at both ends. Try using a different power outlet.

If the power cord has been damaged, turn off MovieMate, disconnect the power cord, and contact Epson. See page 62.

MovieMate turns itself off after a period of time.

The Sleep or Auto Standby functions may be turned on to save power when MovieMate is not in use. Press the  Power button to turn on MovieMate. For more information about power saving functions, see page 40.

No picture appears on the screen.

- Make sure MovieMate is turned on (the  Power light is green and not flashing). If the Image On light is flashing green, wait for MovieMate to warm up. If the Image Off light is flashing orange, wait until it stops flashing, then press the  Power button.
- Make sure the lens cover is off.
- The image may be off the screen. Use the quick image adjustment dials to adjust its position. See page 15.
- Press the  button on MovieMate or on the remote control to make sure the picture hasn't been turned off temporarily.
- Make sure MovieMate is not tilted. Tilting it more than 5 degrees up or down may cause disc problems. Use the quick image adjustment dial to adjust the image position.
- Make sure the region code on the DVD is 1.

- Check the  warning light. If it is flashing orange or red, you need to replace the lamp. See page 49.
- If you're using external video equipment, check the solutions on page 61.

The DVD skips.

- Make sure MovieMate is not tilted. Tilting it up more than 5 degrees may cause skipping or disc scratches. Use the vertical image adjustment dial to adjust the image position.
- Make sure there are no fingerprints on the DVD.

The remote control doesn't work.

- Make sure the toggle switch is in the correct position: set to **-123** to use the numeric buttons, or to **Func.-** to use the other functions of these buttons.
- Make sure you're within 22 feet of MovieMate, and within range of its front or back sensor (approximately 30° left or right, and 15° above or below).
- You may need to replace the remote control's batteries. Make sure they're inserted with the positive (+) and negative (–) ends positioned as shown in the battery compartment.
- Some discs don't support all of the remote control's functions.
- If you're using a "universal" remote control, it might not work with MovieMate. Epson does not support any third-party remote controls.

Solving Picture and Sound Problems

The picture is blurry or out of focus.

- Adjust the focus using the focus ring. See page 15.
- Make sure the lens cover is off.
- There may be dirt on the lens. Clean the lens as described on page 47.
- Make sure the lens is not fogged by condensation. If you've just moved MovieMate from a cold environment, wait approximately an hour before using it. If condensation forms, turn on the main power switch, then wait an hour or two before use.
- Make sure MovieMate is placed the correct distance from the screen: no closer than 2.4 feet (73 cm) and no farther than 37 feet (11.37 m).
- Adjust the **Sharpness** setting. See page 44.

- If you're using the **Keystone** adjustment, be aware that it lessens image quality. You may wish to decrease the projection angle to reduce the amount of keystone correction needed, or use the quick image adjustment dials to position the image. See page 15.
- If you're using external video equipment, check the solutions on page 61.

The picture looks too light or too dark.

- Press the  button on the remote control to select the best setting for your viewing environment. See page 20.
- Adjust the **Brightness** and **Contrast** settings. See page 44.
- The screensaver feature fades out the picture if a still image is projected for more than 5 minutes. See page 44.
- If the picture looks darker than it used to, you may need to replace the lamp. See page 49.

The colors on the screen don't look right.

- Press the  button on the remote control to select the best setting for your viewing environment.
- Adjust the **Color Saturation** or **Tint** settings. See page 44.
- If you're using external video equipment, check the solutions on page 61.



The picture is wider at the top or bottom.

- You've tilted MovieMate to raise or lower the image, causing it to become "keystoned." Use the **Keystone** setting to correct the problem. See page 44.
- Better yet, place MovieMate at a height approximately between the top and bottom of the screen, keeping it level, and then use the vertical image adjustment dial to position the image (see page 15). You won't have to correct for keystone distortion this way, and you'll get a better-looking image.

The picture is taller on the left or right side.

MovieMate is set at an angle to the screen. Face it squarely toward the screen, and then use the horizontal image adjustment dial to center the image. See page 15.

There is no sound, or the sound is not loud enough.

- Try pressing the + Volume button on MovieMate or remote control and turning the volume knob on the optional subwoofer.
- Press the  button on the remote control to make sure the sound hasn't been turned off temporarily.
- Press  and make sure DVD LEVEL 3 is selected for the highest volume.
- If you're using external video equipment, make sure you connected the red and white audio jacks to MovieMate's audio ports (see page 23).
- If you're using an external audio or surround sound system, adjust the settings in the AUDIO setup menu (see pages 42 and 43).
- If you're playing MP3 audio files, you might need to select the FILE TYPE in the PICTURE setup menu (see pages 43 and 44).

There is a problem with the sound quality.

- Try adjusting the sound mode (page 42).
- If you're using an external audio or surround sound system, adjust the settings in the AUDIO setup menu (see pages 42 and 43).
- Try using the Treble buttons on the remote control.
- Try adjusting the crossover knob on the back of the optional subwoofer.

There is no sound coming from the optional subwoofer.

- Make sure you use the audio cable to connect the optional subwoofer to MovieMate.
- Make sure the optional subwoofer's power switch is turned on.
- Try adjusting the volume knob on the front of the optional subwoofer.
- Try adjusting the volume on MovieMate.

Subtitles do not appear.



- The DVD might not include subtitles.
- Make sure the subtitle language is not set to OFF (see page 41).

You can't change the language on a DVD.

The DVD might not include multiple languages.

Problems with External Video Equipment

No picture appears on the screen.

- Make sure the equipment is turned on.
- Press the  Power button on MovieMate or on the remote control.
- Press the  or Play button on the external equipment.
- Make sure you don't have cables connected to more than one video port. You can only use one connection at a time (see page 23).

You see the message No Signal.

- Make sure the equipment is turned on.
- Make sure your cable(s) are connected correctly (see page 23).
- Press the  button on MovieMate or the remote control to select the external video source. Allow a few seconds for MovieMate to sync up.

You see the message Signal not supported.

Press the  button on the remote control and check the Video Signal setting (see page 45).



The picture is cut off (too large) or too small.

Press the  button on the remote control and select the appropriate aspect ratio.

The picture is distorted.

- If you're using an extension cable, electrical interference may affect the signal.
- Check the solutions on pages 58 and 59.

The colors are not right.

- Press the  button on the remote control and check the Video Signal setting (see page 45).
- Press the  button on the remote control to select the best setting for your viewing environment.
- Adjust the Color Saturation or Tint settings. See page 44.

Where To Get Help

Epson provides these technical support services:

Internet Support

Visit Epson's support website at <http://support.epson.com> and select your product for solutions to common problems. You can download utilities and documentation, get FAQ's and troubleshooting advice, or e-mail Epson with your questions.

Visit <http://www.presentersonline.com> to access tips, templates, and training for developing successful presentations.

Speak to a Support Representative

To use the Epson PrivateLine Support service, call (800) 637-7661 and enter the PIN on the included Epson PrivateLine Support card. This is the fastest way of speaking to a live representative, and it's free. This service is available 6 AM to 6 PM, Pacific Time, Monday through Friday, for the duration of your warranty period.

You may also speak with a projector support specialist by dialing one of these numbers:

- U.S.: (562) 276-4394, 6 AM to 6 PM, Pacific Time, Monday through Friday
- Canada: (905) 709-3839, 6 AM to 6 PM, Pacific Time, Monday through Friday

Toll or long distance charges may apply.

Before you call, please have the following information ready:

- Product name (Epson MovieMate 30s)
- Product serial number (located on the bottom of MovieMate)
- Proof of purchase (such as a store receipt) and date of purchase
- Computer or video configuration
- Description of the problem

Note: If you need help with the optional subwoofer or an optional screen, see the information included in the box with the equipment.

Purchase Supplies and Accessories

You can purchase screens, carrying cases, or other accessories from an Epson authorized reseller. To find the nearest reseller, call 800-GO-EPSON (800-463-7766). Or you can purchase online at www.epsonstore.com (U.S. sales) or www.epson.ca (Canadian sales).

Specifications and Notices

This section includes specifications, safety instructions, and other important information about your MovieMate 30s.

MovieMate Specifications

General

Type of display	Poly-silicon TFT active matrix
Size of LCD panels	0.55 inch (14 mm) wide
Lens	F=1.7 to 2.1, f=13.7 to 20.5 mm
Resolution (native format)	854 × 480 pixels × 3, 480p
Brightness	up to 1200 lumens (ANSI)
Contrast ratio	up to 1000:1
Image size	30 to 300 inches (0.76 to 7.6 m)
Projection distance	2.4 to 37.3 feet (0.73 to 11.37 m)
Speakers	JVC dual speakers (10 W × 2)
Zoom ratio	1:1.5
Lens shift (maximum)	50% vertically, 25% horizontally
Optical aspect ratio	Native 16:9 (4:3 resize)
DVD Unit	JVC Digital Direct Progressive Scan System Audio: DTS and Dolby 5.1 Media: DVD Video, DVD-R/RW, Video CD, Super Video CD, Audio CD, MP3 (CD-R/RW), WMA (CD-R/RW), JPEG (CD-R/RW) See page 66 for detailed file specifications.
Noise level	28 dB to 33 dB 26 dB in music-only mode
Keystone correction	Vertical: -15° to +15°
Tilt angle	0°

Remote Control

Range	Approx. 23 feet (7 m)
Battery	AA × 2
Operating angle	Horizontal: +/- 30° Vertical: +/- 15°

Projection Lamp

Type	135 W UHE (Ultra High Efficiency)
Part number	ELPLP33/ V13H010L33
Lamp life	Approx. 2000 hours (all color modes except Theatre Black) Approx. 3000 hours (Theatre Black mode)

Note: Lamp life results will vary depending upon mode selected, environmental conditions and usage.

Turn off this product when not in use to prolong the life of the projector.

Dimensions

Height	7.1 inches (180 mm)
Width	13.4 inches (340 mm)
Depth	12.2 inches (310 mm)
Weight	15.4 lb. (7 kg)

Electrical

Rated voltage	100 to 240 VAC
Rated frequency	50/60 Hz
Power consumption	Operating: 230 W Standby: 6 W

Environmental

Temperature	Operating: 41 to 95 °F (5 to 35 °C) without condensation Storage: 14 to 140 °F (-10 to 60 °C) without condensation
Humidity	Operating: 20 to 80% RH, non-condensing Storage: 10 to 90% RH, non-condensing
Operating altitude	up to 7500 feet (2286 m)

Safety and Approvals

United States FCC Part 15B Class B (DoC)
 UL60950-1

Canada ICES-003 Class B
 CSA C22.2 No.60950-1

Compatible Video Formats

Composite video/S-Video

Signal	Resolution	Normal aspect mode	Wide aspect mode	Zoom aspect mode
TV (NTSC)	720 x 480 720 x 360*	640 x 480 (4:3)	854 x 480 (16:9)	854 x 480 (16:9)
TV (PAL, SECAM)	720 x 576 720 x 432*	640 x 480 (4:3)	854 x 480 (16:9)	854 x 480 (16:9)

* Letterbox signal

Component video

Signal	Resolution	Normal aspect mode	Wide aspect mode	Zoom aspect mode
SDTV (525i, 60Hz)	720 x 480 720 x 360*	640 x 480 (4:3)	854 x 480 (16:9)	854 x 480 (16:9)
SDTV (625i, 50Hz)	720 x 576 720 x 432*	640 x 480 (4:3)	854 x 480 (16:9)	854 x 480 (16:9)
SDTV (525p)	720 x 480 720 x 360*	640 x 480 (4:3)	854 x 480 (16:9)	854 x 480 (16:9)
SDTV (625p)	720 x 576 720 x 432*	640 x 480 (4:3)	854 x 480 (16:9)	854 x 480 (16:9)
HDTV (720p) 16:9	1280 x 720	854 x 480 (16:9)	—	—
HDTV (1080i) 16:9	1920 x 1080	854 x 480 (16:9)	—	—

* Letterbox signal

Computer image

Signal	Resolution	Normal aspect mode	Wide aspect mode	Zoom aspect mode
VGA 60/72/75/85, iMac*	640 x 480	640 x 480	854 x 480	854 x 480
SVGA56/60/72/75/85/, iMac*	800 x 600	640 x 480	854 x 480	854 x 480
XGA60/70/75/85, iMac*	1024 x 768	640 x 480	854 x 480	854 x 480
SXGA60/75/85	1280 x 1024	640 x 480	854 x 480	854 x 480
MAC13"	640 x 480	640 x 480	854 x 480	854 x 480
MAC16"	832 x 624	640 x 480	854 x 480	854 x 480
MAC19"	1024 x 768	640 x 480	854 x 480	854 x 480

* Only supported by models that include a VGA output port.

File Specifications

MovieMate supports MP3, WMA, and JPG files that conform to the following specifications:

File system	ISO9660 level 1 or level 2 (Discs that have been recorded in the packet write [UDF] format cannot be read.)
Filename	Half-width English characters only, with .mp3, .wma, .jpg, or .jpeg file extensions.
Group (folder) count	up to 99
Track (file) count	up to 1000
Bitrate	MP3: 32 to 320 kbps WMA: 64 to 160 kbps
Sampling frequency	16 kHz, 22.05 kHz, 24 kHz, 32 kHz, 44.1 kHz, 48 kHz
Total number of pixels	up to 8192 x 7680

MovieMate can play multi-session recorded discs, but not multiple bitrate files.

MovieMate supports baseline JPEG files created by a digital camera and conforming to the DCF (Design rule for Camera File system) standard. Monochrome JPEG, progressive JPEG, and motion JPEG files are not supported. Certain digital camera functions such as automatic rotation may not be supported.



Pixelworks™ DNX™ ICs are used in this projector.

Language Codes

Code	Language	Code	Language	Code	Language	Code	Language
AA	Afar	GD	Scots Gaelic	MK	Macedonian	SN	Shona
AB	Abkhazian	GL	Galician	ML	Malayalam	SO	Somali
AF	Afrikaans	GN	Guarani	MN	Mongolian	SQ	Albanian
AM	Ameharic	GU	Gujarati	MO	Moldavian	SR	Serbian
AR	Arabic	HA	Hausa	MR	Marathi	SS	Siswati
AS	Assamese	HI	Hindi	MS	Malay (MAY)	ST	Sesotho
AY	Aymara	HR	Croatian	MT	Maltese	SU	Sundanese
AZ	Azerbaijani	HU	Hungarian	MY	Burmese	SV	Swedish
BA	Bashkir	HY	Armenian	NA	Nauru	SW	Swahili
BE	Byelorussian	IA	Interlingua	NE	Nepali	TA	Tamil
BG	Bulgarian	IE	Interlingue	NL	Dutch	TE	Telugu
BH	Bihari	IK	Inupiak	NO	Norwegian	TG	Tajik
BI	Bislama	IN	Indonesian	OC	Occitan	TH	Thai
BN	Bengali Bangla	IS	Icelandic	OM	(Afan) Oromo	TI	Tigrinya
BO	Tibetan	IW	Hebrew	OR	Oriya	TK	Turkmen
BR	Breton	JI	Yiddish	PA	Punjabi	TL	Tagalog
CA	Catalan	JW	Javanese	PL	Polish	TN	Setswana
CO	Corsican	KA	Georgian	PS	Pashto, Pushto	TO	Tongan
CS	Czech	KK	Kazakh	PT	Portuguese	TR	Turkish
CY	Welsh	KL	Greenlandic	QU	Quechua	TS	Tsonga
DA	Danish	KM	Cambodian	RM	Rhaeto- Romance	TT	Tatar
DZ	Bhutani	KN	Kannada	RN	Kirundi	TW	Twi
EL	Greek	KO	Korean (KOR)	RO	Rumanian	UK	Ukranian
EO	Esperanto	KS	Kashmiri	RU	Russian	UR	Urdu
ET	Estonian	KU	Kurdish	RW	Kinyarwanda	UZ	Uzbek
EU	Basque	KY	Kirghiz	SA	Sanskrit	VI	Vietnamese
FA	Persian	LA	Latin	SD	Sindhi	VO	Volapuk
FI	Finnish	LN	Lingala	SG	Sangho	WO	Wolof
FJ	Fijian	LO	Lao	SH	Serbo- Croatian	XH	Xhosa
FO	Faroese	LT	Lithuanian	SI	Singhalese	YO	Yoruba
FY	Frisian	LV	Latvian, Lettish	SK	Slovak	ZU	Zulu
GA	Irish	MG	Malagasy	SL	Slovenian		
		MI	Maori	SM	Samoan		

Important Safety Information

Follow these safety instructions when setting up and using MovieMate:

- Except as specifically explained in this *User's Guide*, do not attempt to service this product yourself. Refer all servicing to qualified service personnel.
- Never open any cover on the projector, except the lamp and filter covers. Dangerous electrical voltages inside the projector can severely injure you.
- The projector and its accessories come packaged in plastic bags. Keep plastic bags away from small children to avoid any risk of suffocation.
- Never look into the projector lens when the lamp is turned on; the bright light can damage your eyes. Never let children look into the lens when it is on.
- Don't place the projector on an unstable cart, stand, or table. Also, don't stand on the projector or place heavy objects on it.
- Never push objects through the cabinet slots or spill liquid into the projector.
- Do not use the projector near water, or sources of heat or vibration. Do not expose it to rain or moisture.
- Do not move the unit during playback.
- Do not touch the projection lens with bare hands.
- Use a damp cloth for cleaning. Do not use liquid or aerosol cleaners. Unplug the projector from the wall outlet before cleaning.
- Never try to remove the lamp immediately after use. Doing so will result in serious burns. Before removing the lamp, turn off the projector and wait approximately one hour for the lamp to cool completely.
- The lamp is fragile and can easily break. If the lamp breaks, handle the projector with extreme care to avoid injury from broken glass, and contact Epson to replace the lamp.
- Do not use the lamp after the lamp replacement period has elapsed, because the possibility of lamp breakage increases. When the lamp replacement message appears, replace the lamp with a new one as soon as possible.
- (Hg) The lamp in this product contains mercury. Please consult your state and local regulations regarding disposal or recycling. Do not put in the trash.
- The lamp in this projector is under high internal pressure and may make a loud noise if it breaks. If it breaks, ventilate the room to prevent mercury gas inside the lamp from being inhaled or coming into contact with the eyes or mouth.
- Do not bring your face close to the projector while it is in use, to prevent inhaling or contact with the gases inside the lamp if it breaks.
- If the lamp breaks and gas from the lamp or fragments of broken glass are inhaled or get into the eyes or mouth, or if any other ill effects are noticed, immediately seek medical advice.
- Use the type of power source indicated on the projector. If you're not sure of the power available, consult the power company.

- If you use the projector in a country other than where you purchased it, use the correct power cord for that country.
- Place the projector near a wall outlet where the plug can be easily unplugged.
- Don't place the projector where the cord can be walked on. This may result in fraying or damage to the plug.
- Don't insert the plug into an outlet with dust present, and insert the plug firmly into the outlet. Failure to do so could result in sparks or fire.
- Don't handle the plug with wet hands.
- Don't overload wall outlets, extension cords, or integral convenience receptacles. This can cause fire or electric shock.
- Unplug the projector from the wall outlet and refer servicing to qualified service personnel under the following conditions: when the power cord or plug is damaged or frayed; if liquid has been spilled into the projector, or if it has been exposed to rain, water, or excessive humidity; if it doesn't operate normally when you follow the operating instructions, or if it exhibits a distinct change in performance, indicating a need for service; if it has been dropped or the housing has been damaged.
- If there is an electrical storm, do not touch the power plug, otherwise you may receive an electric shock.
- Keep the projector unplugged when not in use for extended periods.
- Keep the batteries for the remote control out of the reach of children. Batteries are choking hazards and can be very dangerous if swallowed. If they are swallowed, seek medical attention immediately.
- Replace the batteries as soon as they run out.
- Do not expose batteries to heat or flame.
- Dispose of used batteries according to local regulations.
- Remove the batteries if you won't be using the projector for a long period of time.
- Don't block the slots and openings in the projector case. They provide ventilation and prevent the projector from overheating. Don't operate the projector on a sofa, rug, or other soft surface, or in a closed-in cabinet unless proper ventilation is provided.
- Material or paper may get stuck against the air filter underneath the projector while it is in use. Remove anything from underneath the projector that might get stuck against the air filter in this way.
- Don't place the projector or remote control on top of heat-producing equipment or in a heated place, such as a car.
- Don't use the projector outside of the required temperature range (see page 64). Doing so may cause an unstable display and could lead to projector damage.
- Don't store the projector outside of the required temperature range (see page 64) or in direct sunlight for long periods of time. Doing so may cause damage to the case.
- Make sure there is at least 8 inches of space between the exhaust ventilation slots and the wall or other object.

- Make sure there is at least 4 inches of space between the intake ventilation slots and the wall or other object.
- Do not use the projector with the lens cover on; otherwise, the cover could melt and cause injury.
- Do not turn the volume too high, especially when using headphones. Listening to high volume sounds over an extended period can damage your hearing. Sudden high volume can also damage the speakers.

WARNING: The cord included with this product contains chemicals, including lead, known to the State of California to cause birth defects or other reproductive harm. *Wash hands after handling.* (provided in accordance with Proposition 65 in Cal. Health & Safety Code § 25249.5 et seq)

FCC Compliance Statement

For United States Users

This equipment has been tested and found to comply with the limits for a Class B digital device, pursuant to Part 15 of the FCC Rules. These limits are designed to provide reasonable protection against harmful interference in a residential installation. This equipment generates, uses, and can radiate radio frequency energy and, if not installed and used in accordance with the instructions, may cause harmful interference to radio or television reception. However, there is no guarantee that interference will not occur in a particular installation. If this equipment does cause interference to radio and television reception, which can be determined by turning the equipment off and on, the user is encouraged to try to correct the interference by one or more of the following measures:

- Reorient or relocate the receiving antenna.
- Increase the separation between the equipment and receiver.
- Connect the equipment into an outlet on a circuit different from that to which the receiver is connected.
- Consult the dealer or an experienced radio/TV technician for help.

WARNING

The connection of a non-shielded equipment interface cable to this equipment will invalidate the FCC Certification of this device and may cause interference levels which exceed the limits established by the FCC for this equipment. It is the responsibility of the user to obtain and use a shielded equipment interface cable with this device. If this equipment has more than one interface connector, do not leave cables connected to unused interfaces. Changes or modifications not expressly approved by the manufacturer could void the user's authority to operate the equipment.

For Canadian Users

This Class B digital apparatus meets all requirements of the Canadian Interference-Causing Equipment Regulations.

Declaration of Conformity

According to 47CFR, Part 2 and 15 for Class B Personal Computers and Peripherals; and/or CPU Boards and Power Supplies used with Class B Personal Computers:

We: Epson America, Inc.
Located at: 3840 Kilroy Airport Way
MS 3-13
Long Beach, CA 90806
Telephone: (562) 290-5254

Declare under sole responsibility that the product identified herein, complies with 47CFR Part 2 and 15 of the FCC rules as a Class B digital device. Each product marketed is identical to the representative unit tested and found to be compliant with the standards. Records maintained continue to reflect the equipment being produced can be expected to be within the variation accepted, due to quantity production and testing on a statistical basis as required by 47CFR §2.909. Operation is subject to the following two conditions: (1) this device may not cause harmful interference, and (2) this device must accept any interference received, including interference that may cause undesired operation.

Trade Name: Epson
Type of Product: Projector
Model: EMP-TWD3
Marketing Name: MovieMate 30s

Epson America, Inc. Limited Warranty

Basic Two-Year Warranty and 90-Day Lamp Warranty

What Is Covered: Epson America, Inc. (“Epson”) warrants to the original retail purchaser of the Epson product enclosed with this limited warranty statement that the product, if purchased new and operated in the United States or Canada, will be free from defects in workmanship and materials for a period of two (2) years from the date of original purchase (except that the warranty period is 90 days for projector lamps). For warranty service, you must provide proof of the date of original purchase.

What Epson Will Do To Correct Problems: If your product requires service, Epson will ask you to bring the product securely packaged in its original container or equivalent, along with proof of the date of original purchase, to your Epson Dealer or Epson Customer Care Center as instructed by Epson. Epson will, at its option, repair or replace the defective unit, without charge for parts or labor. When warranty service involves the exchange of the product or of a part, the item replaced becomes Epson property. The exchanged product or part may be new or previously refurbished to the Epson standard of quality, and at Epson’s option, the replacement may be another model of like kind and quality. Epson’s liability for replacement of the covered product will not exceed the original retail selling price

of the covered product. Exchange or replacement products or parts assume the remaining warranty period of the product covered by this limited warranty. However, each replacement lamp carries the limited 90-day warranty stated above.

What This Warranty Does Not Cover: This warranty does not apply to refurbished or reconditioned products. This warranty covers only normal use of the product. 24-hour-per-day or other high duty commercial use causes strain and is not considered normal use. This warranty does not cover consumables (e.g., filters), other than lamps as provided herein. This warranty is not transferable. Epson is not responsible for warranty service should the Epson label or logo or the rating label or serial number be removed. Epson is not responsible for warranty service should the product fail to be properly maintained or fail to function properly as a result of misuse, abuse, improper installation, neglect, improper shipping, damage caused by disasters such as fire, flood, and lightning, improper electrical current, software problems, interaction with non-Epson products, use in a smoke or dust-filled environment, or service other than by an Epson Authorized Servicer. Postage, insurance, or shipping costs incurred in presenting your Epson product for carry-in warranty service are your responsibility. If a claimed defect cannot be identified or reproduced in service, you will be held responsible for costs incurred.

THE WARRANTY AND REMEDY PROVIDED ABOVE ARE EXCLUSIVE AND IN LIEU OF ALL OTHER EXPRESS OR IMPLIED WARRANTIES INCLUDING, BUT NOT LIMITED TO, THE IMPLIED WARRANTIES OF MERCHANTABILITY OR FITNESS FOR A PARTICULAR PURPOSE. SOME LAWS DO NOT ALLOW THE EXCLUSION OF IMPLIED WARRANTIES. IF THESE LAWS APPLY, THEN ALL EXPRESS AND IMPLIED WARRANTIES ARE LIMITED TO THE WARRANTY PERIOD IDENTIFIED ABOVE. UNLESS STATED HEREIN, ANY STATEMENTS OR REPRESENTATIONS MADE BY ANY OTHER PERSON OR FIRM ARE VOID. IN THE EVENT THE REMEDIES ABOVE FAIL, EPSON'S ENTIRE LIABILITY SHALL BE LIMITED TO A REFUND OF THE PRICE PAID FOR THE EPSON PRODUCT COVERED BY THIS LIMITED WARRANTY. EXCEPT AS PROVIDED IN THIS WRITTEN WARRANTY, NEITHER EPSON AMERICA, INC. NOR ITS AFFILIATES SHALL BE LIABLE FOR ANY LOSS, INCONVENIENCE, OR DAMAGE, INCLUDING DIRECT, SPECIAL, INCIDENTAL, OR CONSEQUENTIAL DAMAGES, RESULTING FROM THE USE OR INABILITY TO USE THE EPSON PRODUCT, WHETHER RESULTING FROM BREACH OF WARRANTY OR ANY OTHER LEGAL THEORY.

In Canada, warranties include both warranties and conditions.

Some jurisdictions do not allow limitations on how long an implied warranty lasts and some jurisdictions do not allow the exclusion or limitation of incidental or consequential damages, so the above limitations and exclusions may not apply to you. This warranty gives you specific legal rights, and you may also have other rights, which vary from jurisdiction to jurisdiction.

To find the Epson Authorized Reseller nearest you, visit our website at: www.epson.com.

To find the Epson Customer Care Center nearest you, visit <http://support.epson.com>.

You can also call the Epson ConnectionSM at (800) 637-7661 + PIN or (562) 276-4394 in the U.S. and (905) 709-3839 in Canada or write to: Epson America, Inc., P.O. Box 93012, Long Beach, CA 90809-3012.

Index

A

- A-B repeat, 35
- Accessories, 8, 62
- Air filters
 - cleaning and replacing, 48 to 49
 - ordering, 8
- Air vents, 9
- Audio
 - adjusting, 16, 42 to 43
 - problems, 60
- Audio system connection, 28
- Auto Standby, 40
- AV amplifier, connecting, 28

B

- Bag, carrying, 8
- Batteries, replacing, 13
- Blurry picture, 58 to 59
- Brightness
 - lamp, 50, 63
 - setting, 44
- Buttons, 10

C

- Cable box, connecting, 23 to 25
- Camcorder, connecting, 23 to 25
- Camera angle, 37
- Carrying bag, 8
- CDs, playing, 33
- Child Lock, 40
- Cleaning
 - air filters, 48 to 49
 - lens and MovieMate case, 47 to 48
- Color mode, 20, 49, 59, 61
- Color problems, 59, 61
- Color saturation setting, 44

- Composite video connection, 24
- Computer connection, 29 to 30
- Contrast ratio, 63
- Contrast setting, 44
- Control panel, MovieMate, 10

D

- Dark image, 59
- Declaration of Conformity, 71
- Digital audio output, 43
- Digital audio recorder, connecting, 28
- Digital audio, connecting, 27
- Digital camera, connecting, 23 to 25
- Display window dimmer, 46
- Distance, projection, 12, 63
- Documentation, 8
- Dolby digital, 43
- Downmix, 43
- DVD level, 25, 28, 30, 42
- DVD tray, locking, 40
- DVDs
 - inserting, 14
 - menus, 20
 - playing, 11 to 21
- DVR, connecting, 23 to 25
- Dynamic range compression, 43

E

- Electrical specifications, 64
- Environmental specifications, 64
- Epson
 - accessories, 8, 62
 - Home Service, 7
 - PrivateLine Support, 62
 - technical support, 8, 62
- Exhaust vent, 9

External equipment
connecting, 23 to 30
problems, 61

F

Fast forward, 19
FCC Compliance Statement, 70
File specifications, 66
File type setting, 44
Filters, *see* Air filters
Focus ring, 15
Formats, video, 65 to 66

G

Game console, connecting, 23 to 25
General specifications, 63

H

Headphones, 21
Help, 8, 62
High altitude mode, 45, 56
Home Service, 7
Horizontal lens shift, 12, 15

I

Image
blurry, 58 to 59
distorted, 59
shape, 44, 59, 63
size, 12, 63
too light or dark, 59
turning off, 20
wrong colors, 59
Image adjustment dials, 12, 15, 63
Intake vent, 9
iPod, connecting, 23 to 25, 27

J

Jog control, 19
JPEG, 34, 43, 66

K

Kensington lock, 8
Keystone correction, 44, 59, 63

L

Lamp
brightness, 50, 63
light, 56
ordering, 8, 50
replacing, 49 to 51
specifications, 64
usage timer, resetting, 45, 52
Language, 37, 41, 67
Laptop connection, 29 to 30
Lens cover, 17
Lens shift, 12, 15, 63
Lens, cleaning, 47
Lights, MovieMate, 55 to 56
Location, MovieMate, 11 to 13
Lock, security, 8
Locking DVD tray, 40
Locking Power button, 40
Looping, 35

M

Maintenance, 47 to 52
Menus, 20

MovieMate
 choosing location, 11 to 13
 cleaning, 48
 control panel, 10
 dimensions, 64
 distance from screen, 12, 63
 lights, 55 to 56
 maintenance, 47 to 52
 operation problems, 57 to 58
 parts, 9
 positioning, 11 to 13
 speakers, 63
 specifications, *see* Specifications
 storing, 52
 transporting, 53
 turning off, 16 to 17

Movies
 pausing, 18
 playing, 11 to 21
 searching, 19, 37

MP3, 34, 43, 66

MP3 player, connecting, 27

Music, playing, 33 to 34

Muting, 20

N

No Signal message, 61

O

On-screen guide, 41

On-screen menu, 35, 37

Optical audio-out port, using, 28

Optional accessories, 8

Optional subwoofer connection, 26

Overheating, 13, 48, 56

P

Parental controls, 39

Parts, identifying, 9 to 10

Pausing, 18

PBC (Playback Control), 38

PCM, 43

Photos, displaying, 33 to 34

Picture
 adjusting, 15, 20, 43 to 45
 problems, 57 to 59

Picture source setting, 44

Pixelworks DNX, 65

Positioning MovieMate, 11 to 13

Power button locking, 40

Power, saving, 40

Problems
 audio, 60
 color, 59, 61
 lights indicating, 55 to 56
 operation, 57 to 58
 overheating, 13, 48, 56
 picture, 57 to 59
 remote control, 58

Program play, 36

Projection distance, 12, 63

R

Random play, 36

Registration, 7

Remote control
 batteries, 13
 buttons, 10
 problems, 58
 specifications, 64

Repeating scenes or tracks, 35

Replacing lamp, 49 to 51

Resetting lamp timer, 45, 52

Resolution, 63

Resume setting, 41

S

- Safety
 - approvals, 65
 - instructions, 68 to 70
- Satellite receiver, connecting, 23 to 25
- Scenes, replaying, 19
- Screen distance, 12, 63
- Screen projection, 30 to 32
- Screen saver setting, 44
- Searching, 19, 37
- Sharpness setting, 44
- Shuttle control, 19
- Signal not supported message, 61
- Size, image, 12, 63
- Skipping chapters or tracks, 19
- Sleep mode, 40, 55, 57
- Slow motion, 19
- Sound
 - adjusting, 16, 42 to 43
 - problems, 60
- Sound mode, 42
- Sources, switching, 61
- Speakers, MovieMate, 63
- Specifications
 - compatible video formats, 65 to 66
 - electrical, 64
 - environmental, 64
 - file specifications, 66
 - general, 63
 - lamp, 64
 - language codes, 67
 - remote control, 64
- Storing MovieMate, 52
- Subtitles, 37
- Subwoofer, optional connection, 26
- Support, *see* Technical support
- Surround sound system, connecting, 28
- S-Video connection, 24

T

- Technical support, 8, 62
- Temperature, MovieMate, 48, 56
- Time search, 37
- Tint setting, 44
- Transporting MovieMate, 53
- Tray Lock, 40
- TV video formats, 65 to 66

V

- VCR, connecting, 23 to 25
- Ventilation, 13, 48, 56
- Vents, 9
- Vertical lens shift, 12, 15
- Video camera, connecting, 23 to 25
- Video Signal setting, 45
- Video, compatible formats, 65 to 66
- Visual Adjust button, 44
- Volume, adjusting, 16

W

- Wall projection, 30 to 32
- Warranty, 7, 71 to 72
- WMA, 34, 43, 66

Z

- Zoom ring, 15

Epson MovieMate 30s Series