

# TABLE OF CONTENTS

## Usage Notice

<i>Precautions</i> .....	3
<i>Eye Safety Warnings</i> .....	5

## Introduction

<i>Product Features</i> .....	6
<i>Package Overview</i> .....	7
<i>Product Overview</i> .....	8
<i>Main Unit</i> .....	8
<i>Projector Panel</i> .....	9
<i>DVD Panel</i> .....	9
<i>Connection Ports</i> .....	10
<i>Remote Control</i> .....	11

## Installation

<i>Setting up the Projector</i> .....	12
<i>Connecting the Computer/Notebook</i> .....	12
<i>Connecting the Video</i> .....	13
<i>Connecting the Audio Input</i> .....	14
<i>Connecting the Audio Output-(External Subwoofer/Stereo System)</i> .....	14
<i>Connecting the Audio Output-(2.1 Channel/5.1 Channel)</i> .....	15
<i>Powering On/Off the Projector</i> .....	16
<i>Powering On the Projector</i> .....	16
<i>Turn On the DVD Player</i> .....	17
<i>Turn Off the DVD Player</i> .....	17
<i>Powering Off the Projector</i> .....	18
<i>Warning Indicator</i> .....	19
<i>Adjusting the Projected Image</i> .....	20
<i>Adjusting the Projector's Height</i> .....	20
<i>Adjusting the Projector's Focus</i> .....	21
<i>Adjusting the Projection Image Size</i> .....	21
<i>Adjusting the Aspect Ratio of the Image</i> .....	22
<i>Adjusting the Sloping Image</i> .....	23

## User Controls

<i>Control Panel &amp; Remote Control</i> .....	24
<i>Using the Remote Control</i> .....	24

# TABLE OF CONTENTS

<i>Using the Projector Panel</i> .....	26
<i>Using the DVD Panel</i> .....	27
<i>On-screen Display Menus</i> .....	28
<i>How to Operate Projector Menu</i> .....	28
<i>Menu Tree for Projector</i> .....	29
<i>Language</i> .....	30
<i>Image-I</i> .....	31
<i>Image-II</i> .....	33
<i>Display</i> .....	35
<i>System</i> .....	37
<i>Lamp setting</i> .....	39
<i>How to Operate WMA/MP3/JPEG Program</i> .....	40
<i>How to Operate DVD Menu</i> .....	41
<i>Menu Tree for DVD</i> .....	42
<i>System Setup</i> .....	43
<i>Language Setup</i> .....	45
<i>Digital Setup</i> .....	46
<i>Video Setup</i> .....	47
<i>Speaker Setup</i> .....	48
 <b>Maintenance</b>	
<i>Troubleshooting</i> .....	49
<i>Image Problems</i> .....	49
<i>Projector Operation Problems</i> .....	51
<i>LED Problems</i> .....	51
<i>DVD Player Problems</i> .....	52
<i>Sound Problems</i> .....	53
<i>Remote Control Problems</i> .....	54
<i>Replacing the Lamp</i> .....	55
<i>Compatibility Modes</i> .....	56
<i>Ceiling Mount Installation</i> .....	57
<i>Optoma Global Offices</i> .....	58
<i>Regulation &amp; safety notices</i> .....	59

## Precautions



*Please follow all warnings, precautions, and maintenance procedures as recommended in this user's guide.*

- ■ To reduce the risk of fire or electric shock, do not expose this product to rain or moisture.
- ■ To prevent the risk of electric shock, do not open or disassemble the product.
- ■ Please allow the unit to cool down before changing the lamp; carefully follow the lamp replacement instructions listed under "Replacing the lamp".
- ■ This product self-detects the life of the lamp and will display a warning message when the lamp is about to expire. Be sure to replace the lamp when the warning message is displayed.
- ■ After installing a new lamp, reset the lamp life using the on-screen menu.
- ■ Before turning off the product, follow the cooling fan to run for several minutes.
- ■ Turn on the projector first and then select the signal sources.
- ■ Do not use lens cap when projector is in operation.
- ■ When the lamp reaches the end of its life, it will burn out and may make a loud "popping" sound. If this occurs, the projector will not turn back on until the lamp module has been replaced. To replace the lamp, follow the procedures listed under "Replacing the Lamp".

# USAGE NOTICE

English



**Do:**

- ■ Turn off the product before cleaning.
- ■ Use a soft cloth moistened with mild detergent to clean the display housing.
- ■ Disconnect the power plug from AC outlet if the product is not being used for a long period of time.



**Do not:**

- ■ Block the slots and openings on the unit provided for ventilation.
- ■ Place the unit under direct sunlight.
- ■ Use abrasive cleaners, waxes or solvents to clean the unit.
- ■ Use under the following conditions:
  - Extremely heat, cold or humidity.
  - In areas susceptible to excessive dust and dirt.
  - Near any appliance generating a strong magnetic field.
  - In direct sunlight.

## Eye Safety



- ■ Avoid staring directly into the projector beam at all times.
- ■ Minimize standing facing into the beam. Keep your back to the beam as much as possible.
- ■ Use of a stick or laser pointer to avoid the need for the user to enter the beam is recommended.
- ■ Ensure that projectors are located out of the sight line from the screen to the audience; this ensures that, when presenters look at the audience, they do not also have to stare at the projector lamp. The best way to achieve this is by ceiling-mounting rather than floor or table-mounting the projector.
- ■ When projector is used in a classroom, adequately supervise students when they are asked to point out something on the screen.
- ■ In order to minimize the lamp power needed to project a visible presentation, use room blinds to reduce ambient light levels.

## Product Features

*This product is a single chip DLP® projector with built-in DVD player featuring:*

- ■ Uses 4 segment RGBW color wheel
- ■ IR remote control
- ■ User-friendly multilingual on-screen display menu
- ■ Advanced digital keystone correction and high quality full screen image re-scaling
- ■ User-friendly control panel
- ■ Video compatibility- NTSC/PAL/SECAM video capability with S-video, composite and HDTV (480i/p, 576i/p, 720p, 1080i)
- ■ Computer compatibility- SXGA, XGA compression and VGA re-sizing
- ■ Pure digital DVD to projector connection
- ■ Built-in 5W x 2 stereo speakers
- ■ Digital audio output and stereo output
- ■ DVD player compatibility-

Media Compatibility: DVD, DVD-R, DVD+R, DVD-RW, DVD+RW, CD-R, CD-RW

Format Compatibility: DVD, VCD, Audio CD, MP3, WMA, JPEG

## Package Overview

*This projector comes with all the items shown below. Check to make sure your unit is complete.*



Projector with lens cap



Composite Video Cable  
1.8m (For USA and ASIA  
ONLY)



VGA Cable 1.8m  
(For Europe ONLY)



Power Cord 1.8m



D-Sub to RCA Adapter  
(For USA and ASIA  
ONLY)



SCART RGB/S-video  
Adapter  
(For Europe ONLY)



IR Remote Control



AA Battery x 2

### Note

Due to the difference in applications for each country, some regions may have different accessories.

### Documentation :

- User's Manual
- Warranty Card
- Quick Start Card



Carrying Case

## Product Overview

### Main Unit



1. Zoom Lever
2. Focus Ring
3. Zoom Lens
4. Elevator Button
5. Elevator Foot
6. IR Receivers

7. DVD Panel
8. Projector Panel
9. Connection Ports
10. Power Socket
11. Speakers



## Projector Panel

1. Lamp LED  
 2. Temperature LED  
 3. Source  
 4. Menu  
 5. Resync  
 6. Stand by Button/Power LED  
 7. Volume -  
 8. Volume +  
 9. Enter  
 10. Four Directional Select Keys

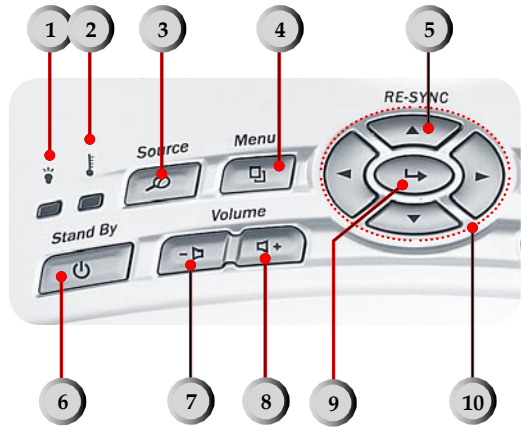

## DVD Panel

1. Play/Pause  
 2. Stop  
 3. DVD LED  
 4. Enter  
 5. Four Directional Select Keys  
 6. PREV Button  
 7. NEXT Button  
 8. Eject Button

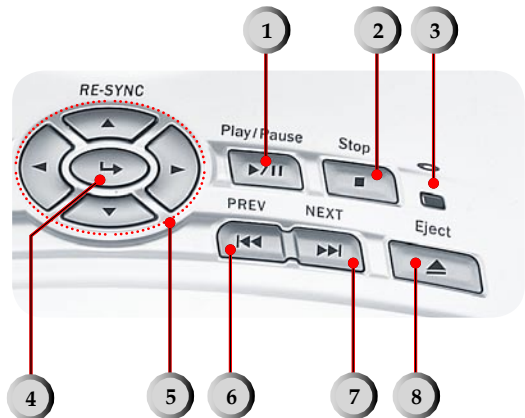

## Connection Ports

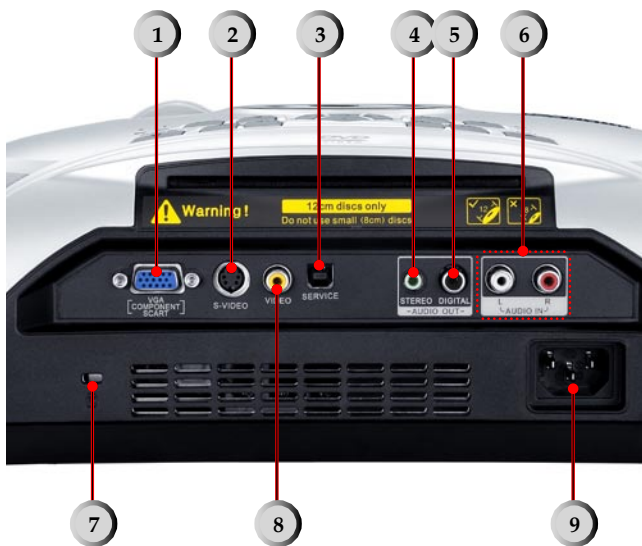

- .....
1. VGA Input Connector (PC Analog signal/SCART RGB/HDTV/Component Video)
  2. S-Video Input Connector
  3. Service Connector
  4. Stereo Audio Output Connector
  5. Digital Audio Output Connector
  6. Audio Input Connector
  7. Kensington Microsaver™ Lock Port
  8. Composite Video Input Connector
  9. Power Socket
- .....

## Remote Control

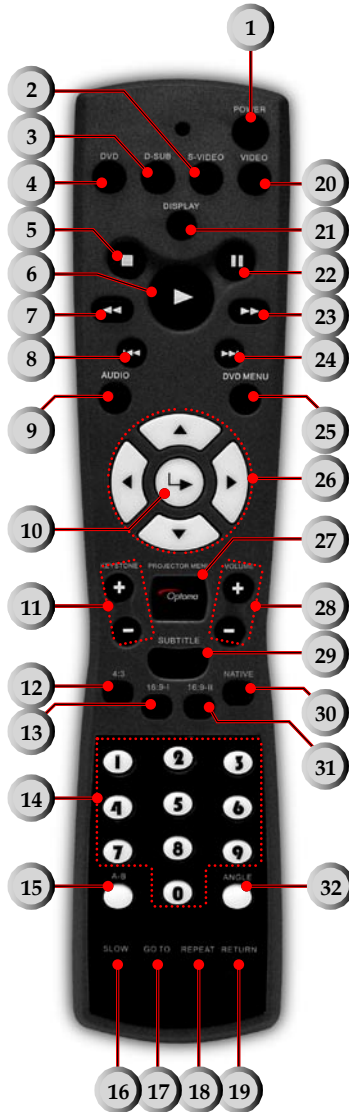

1. Power On/Off
2. S-Video Source
3. D-Sub Source
4. DVD Source
5. Stop Button
6. Play Button
7. REW Button
8. PREV Button
9. Audio
10. Enter
11. Keystone +/-  
12.4:3
- 13.16:9-I
- 14.Numerical Buttons
- 15.A-B Repeat
- 16.Slow Button
- 17.GOTO Button
- 18.Repeat Button
- 19.Return Button
- 20.Video Source
- 21.Display
- 22.Pause Button
- 23.FWD Button
- 24.NEXT Button
- 25.DVD Menu
- 26.Four Directional Select  
Keys
- 27.Projector Menu
- 28.Volume +/-
- 29.Subtitle
- 30.Native
- 31.16:9-II
- 32.Angle

## Setting up the Projector

### Connecting the Computer/Notebook

1. Power cord  
2. VGA cable

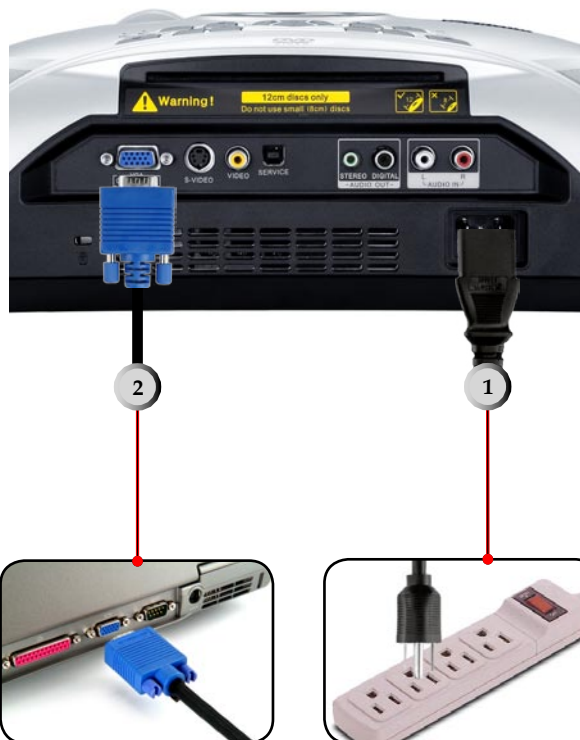

## Connecting the Video

- 1. Power cord
- 2. Video cable
- 3. S-Video Cable
- 4. D-Sub to RCA Adapter
- 5. RCA Component Cable for YPbPr
- 6. SCART RGB/S-video Adapter

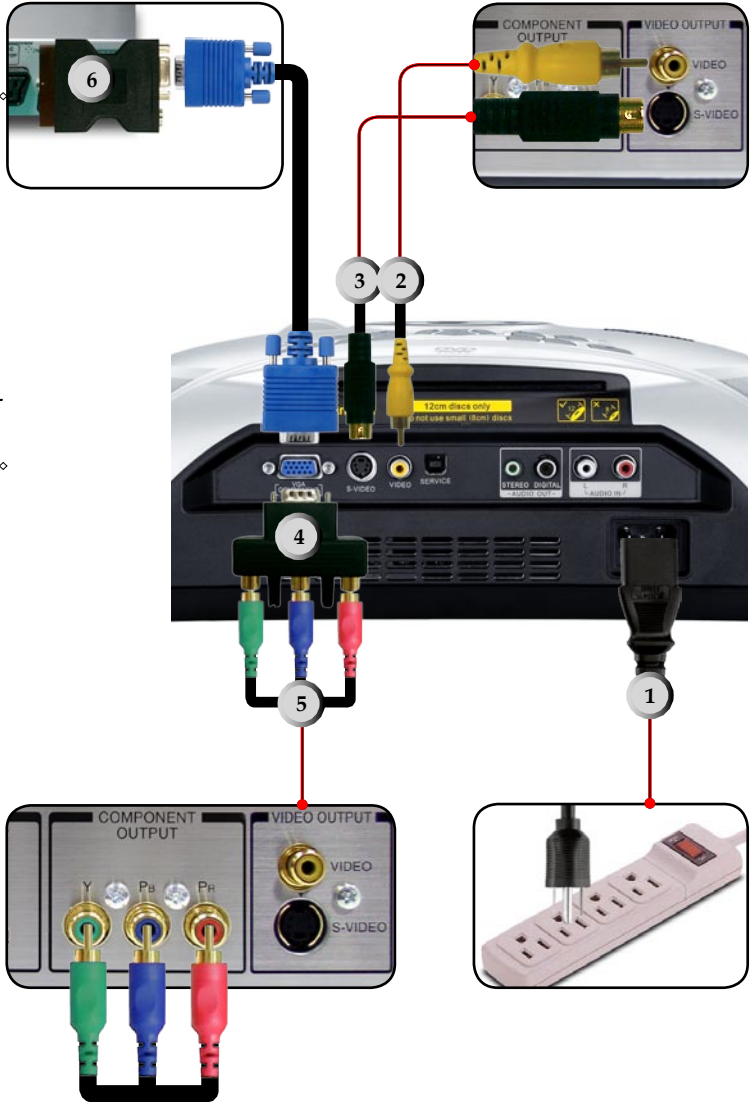

### Note

The user can install the connection port according to their environment of audio and video equipments or demand.

## Connecting the Audio Input

- 1. Power cord
- 2. Audio cable (L/R)

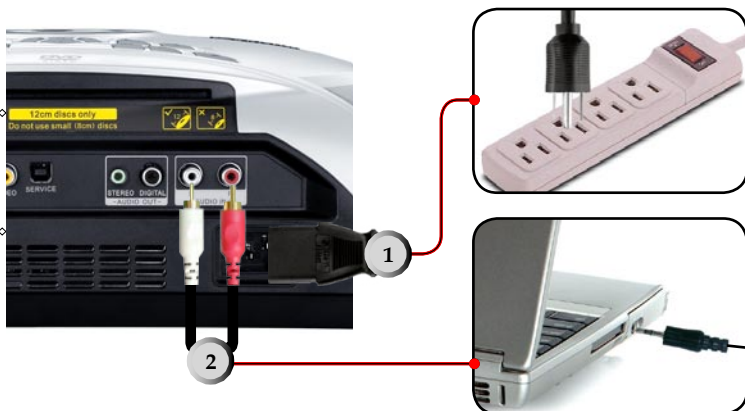

## Connecting the Audio Output- (External Subwoofer/Stereo System)

- 1. Power cord
- 2. Audio cable



## Connecting the Audio Output- (2.1 Channel/5.1 Channel)

- 1. Power cord
- 2. Digital audio cable

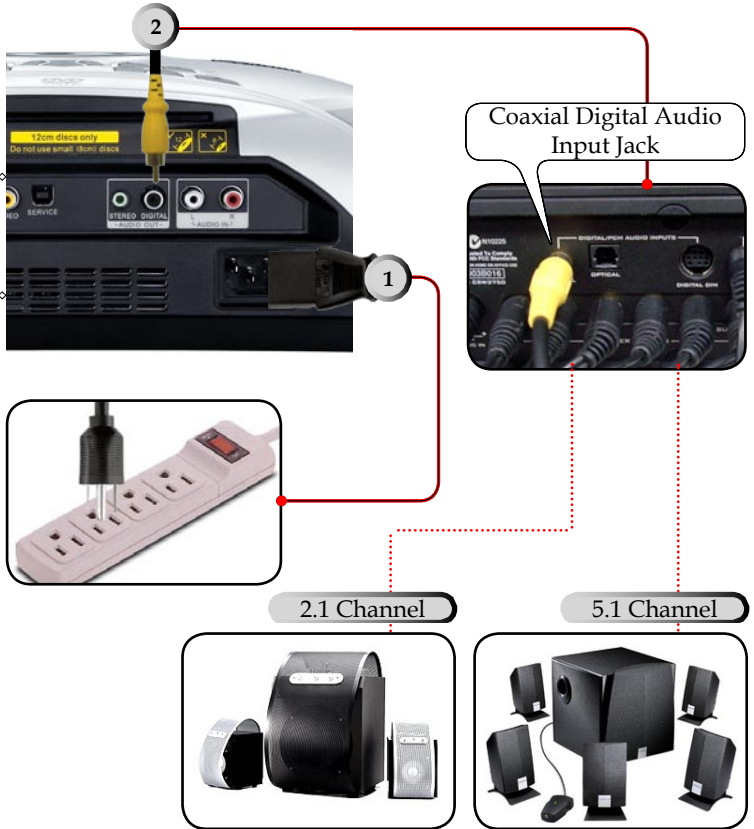

## Powering On/Off the Projector

### Powering On the Projector

1. Remove the lens cap. ❶
2. Ensure that the power cord and signal cable are securely connected. The Power LED will flash blue.
3. Turn on the lamp by pressing [Stand By] button on the control panel. And the Power LED will turn green. ❷

The first time you use the projector, you can select your preferred language from quick menu after the startup screen display.

4. Turn on your source (computer, notebook, video player, etc.). The projector will detect your source automatically within "System" menu; check that "Source Lock" has been set to "Off".

- If you connected multiple sources at the same time, press the [Source] button on the control panel or direct source key on the remote control to switch between inputs.

#### Note

Turn on the projector first and then select the signal sources.

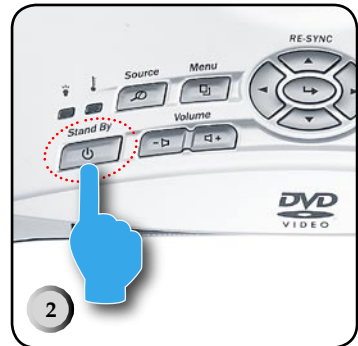



## Turn On the DVD Player

1. Remove the lens cap.
2. Ensure that the power cord and signal cable are securely connected. The DVD LED will flash green.
3. Turn on the lamp by pressing [Stand By] button on the control panel. And the DVD LED will turn green.  
If the DVD player load the disc, you will see a message "Read disc" displayed on the projector's screen. If the DVD player does not load the disc, the start-up screen will display on the projector's screen.
4. Insert the DVD disc on the unit. ❶



## Turn Off the DVD Player

1. Press ▲ [Eject] on DVD panel. ❷
2. Remove the DVD disc on the unit. ❸

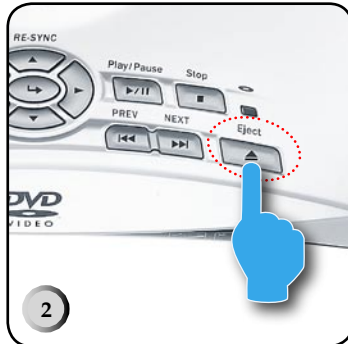

DVD compatibility type		
Type of disc	Diameter	Recorder
DVD	12cm	DVD data format: compressed digital audio + compressed digital video
VCD	12cm	MPEG compressed digital audio + compressed digital video
Audio CD	12cm	CD-DA: digital audio
MP3/JPEG	12cm	Compressed digital audio
WMA	12cm	Compressed digital audio
JPEG	12cm	Digital Photo

## Powering Off the Projector

1. Press the [Power] or [Stand By] button to turn off the projector lamp, you will see a message “Power off the lamp? Picture Mute” displayed on the projector’s screen. Press the [Power] or [Stand By] button again to confirm, otherwise the message will disappear after 5 seconds.

Please note that if the key ► is pressed instead, the projector will enter the “Picture Mute” mode and no image will be displayed. To exit the “Picture Mute” mode, press the [Power] or [Stand By] button again.

2. The cooling fans continue to operate for about 60 seconds for cooling cycle and the Power LED will flash green. When the Power LED begins flashing blue, the projector has entered standby mode.

If you wish to turn the projector back on, you must wait until the projector has completed the cooling cycle and has entered standby mode. Once in standby mode, simply press [Power] or [Stand By] button to restart the projector.

3. Disconnect the power cord from the electrical outlet and the projector.

4. The projector cannot be turned on immediately following a power off procedure.

## Warning Indicator

- When the “LAMP” indicator lights solid orange, the projector will automatically shut itself down. Please contact your local reseller or service center.
- When the “TEMP” indicator lights solid orange, it indicates the projector has been overheated. The projector will automatically shut itself down. Under normal conditions, the projector can be switched on again after it has cooled down. If the problem persists, you should contact your local dealer or our service center.



- When the “TEMP” indicator flashes orange for about 10 seconds, it indicates the fan has failed. Please contact your local dealer or our service center.



- When the “TEMP” indicator flashes orange, it indicates the photo sensor failed. Please contact your local dealer or our service center.
- When the “LAMP” indicator flashes orange, it indicates the color wheel sensor failed. Please contact your local dealer or our service center.

## Adjusting the Projected Image

### Adjusting the Projector's Height

*The projector is equipped with three adjustable feet to modify the height of the projector.*

**To raise or lower the image:**

1. Locate the elevator foot. Press the elevator button ❶ to extend the foot so it may be adjusted.
2. While holding down the elevator button, adjust the foot to the desired height ❷, then release the button to lock the elevator foot into position.
3. Use ❸ to fine-tune tilt-adjustment.
4. Lower the projector so it rests on its foot; adjust as needed.



- xxxxxxxxxxxxxxxxxxxxxxxxxxxxxxxx
1. Elevator Button
  2. Elevator Foot
  3. Tilt-adjustment Feet
- xxxxxxxxxxxxxxxxxxxxxxxxxxxxxxxx

## Adjusting the Projector's Zoom/Focus

Turn the Zoom Lever to zoom in or zoom out. To focus the image, turn the focus ring until you see a clear image. The projector will focus at distances from 4.92 to 32.80 feet (1.5 to 10.0 meters).



## Adjusting Projection Image Size

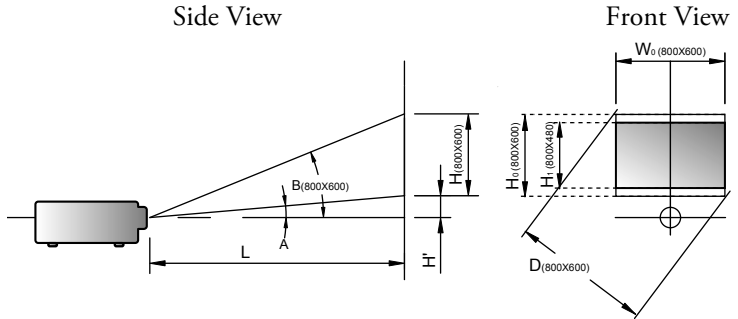

Throw Ratio (TR)=1.36 as Wide mode							
$A=4.73^\circ$		$B(800 \times 600)=32.375^\circ$			$W_0(800 \times 600)=L/TR$		
$H'=L \times \tan(A)$				$H(800 \times 600)=W_0(800 \times 600) \times 0.75$			
Display Format	A	B	L (cm)	W (cm)	H (cm)	H' (cm)	D (cm)
16:9 (800x480)	7.31	28.44	236.0	173.6	97.6	30.20	199.1
4:3 (800x600)	4.73	32.38	236.0	173.6	130.2	19.53	217.0
Projection Distance (M)	1.5	2.0	2.5	3.0	3.5	4.0	
Screen Size 16:9 (inch)	Max	49.82	66.43	83.04	99.64	116.25	132.56
	Min	45.29	60.39	75.49	90.58	105.68	120.78
Screen Size 4:3 (inch)	Max	54.28	72.37	90.46	108.56	126.65	144.74
	Min	49.34	65.79	82.24	98.69	115.14	131.58
Projection Distance (M)	5.0	6.0	7.0	8.0	9.0	10.0	
Screen Size 16:9 (inch)	Max	166.07	199.28	232.50	265.71	298.93	332.14
	Min	150.97	181.17	211.36	241.56	271.75	301.95
Screen Size 4:3 (inch)	Max	180.93	217.11	253.30	289.49	325.67	361.86
	Min	164.48	197.38	230.27	263.17	296.07	328.86

## Adjusting the Aspect Ratio of the Image

Depending on the type of video source you are viewing, the picture may or may not always look correct or fit on the screen:

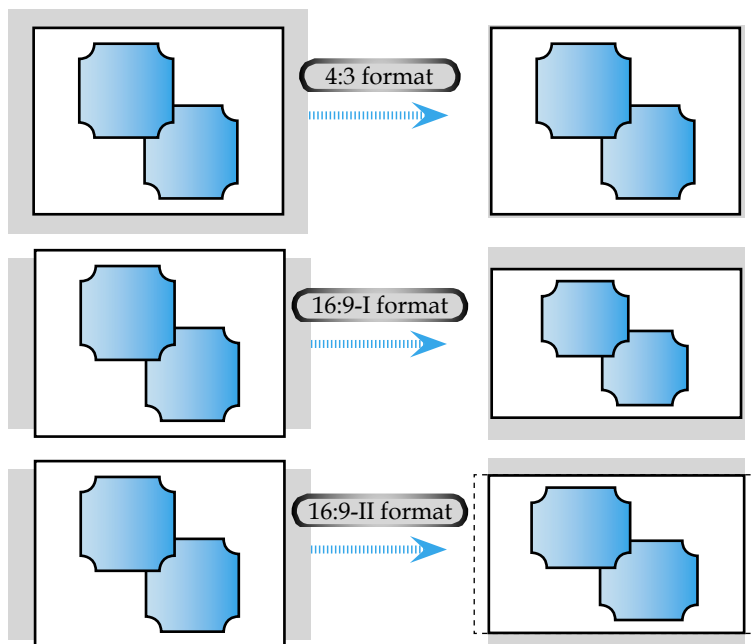

## Adjusting the Sloping Image

If the projector is tilted up or down, the sides of the image on the screen might slope in or out, even though the top and bottom are level. Using the [Keystone +/-] button to adjust the image.

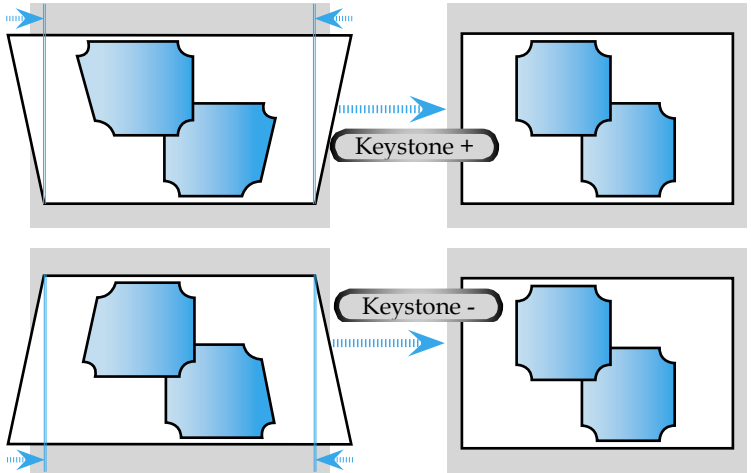

## Control Panel & Remote Control

There are two ways for you to control the functions: with control panel and remote control.



### Using the Remote Control

<b>Power</b>	Press [Power] to turns on the projector's lamp, refer to the "Powering On/Off the Projector" section on page 16~19 for more details.
<b>4:3</b>	Scale the image at a 4:3 aspect ratio.
<b>16:9-I</b>	Scale the image at a 16:9 aspect ratio.
<b>16:9-II</b>	Scale to 854x480, then center 800x480 image to display.
<b>Native</b>	The input source will be displayed without scaling.
<b>DVD</b>	Choose DVD source.
<b>D-SUB</b>	Choose Analog RGB/Component sources from VGA/Component/SCART connector.
<b>S-VIDEO</b>	Choose S-Video source from S-VIDEO connector.
<b>VIDEO</b>	Choose composite video source from VIDEO connector.
<b>Enter</b>	Confirm your item selection.
<b>Projector Menu</b>	Display or exits the on-screen display menus for projector.
<b>Four Directional Select Keys</b>	Use ▲▼◀▶ to select items or make adjustments to your selection.
<b>Keystone +/-</b>	Adjusts image distortion caused by tilting the projector.
<b>Volume +/-</b>	Adjusts to increase/decrease the volume.
<b>DVD Menu</b>	Some DVDs allow you to select the disc contents using the menu. When you play back these DVDs, you can select the subtitle language and sound-track language, etc. using the menu.









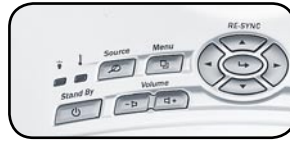





<b>Display</b>	Display DVD's states (title; chapter; time; information).
<b>Subtitle</b>	Select the desired your subtitle language.
<b>Audio</b>	Select the desired audio language or sound mode.
<b>Numerical Buttons</b>	Selects track numbers for playback.
<b>A-B Repeat</b>	Repeats playback of the selected section.
<b>Angle Button</b>	Choose the camera angle to see the sequence being played back from a different angle. When a DVD contains multiple angles of a particular scene, you can use the ANGLE function.
<b>◀◀ REW Button</b>	Press to search backward in x2/x4/x8/x20 speed.
<b>◀◀ PREV Button</b>	Press to skip to the previous title/chapter.
<b>▶▶ NEXT Button</b>	Press to skip to the next title/chapter.
<b>▶▶ FWD Button</b>	Press to search forward in x2/x4/x8/x20 speed.
<b>▶ Play Button</b>	Press to begin playback.
<b>■ Stop Button</b>	Press to stop playback.
<b>   Pause Button</b>	Press to pause playback. Press the ▶ [Play] button to resume normal playback.
<b>Slow</b>	Press to activate slow forward or slow rewind.
<b>Goto</b>	Press to select the desired disc starting time, chapter or title.
<b>Repeat</b>	Repeats playback of the current disc, title, chapter or track.
<b>Return</b>	Returns to the previous operation.

## Using the Projector Panel



 <b>Stand By</b>	Press [Stand By] to turns on the projector's lamp, refer to the "Powering On/Off the Projector" section on page 16~19 for more details.
<b>Power LED</b>	Indicate the projector's status.
 <b>Lamp LED</b>	Indicate the projector's lamp status.
 <b>Temp LED</b>	Indicate the projector's temperature status.
 <b>Volume +/-</b>	Adjusts to increase/decrease the volume.
 <b>Source</b>	Press to choose RGB, S-Video, Composite, Component, and HDTV sources.
<b>Resync</b>	Automatically synchronizes the projector to the input source.
 <b>Enter</b>	Confirm your item selection.
 <b>Menu</b>	Display or exit the on-screen display menus for projector.
<b>Four Directional Select Keys</b>	Use     to select items or make adjustments to your selection.

### Note

The Resync function can not be used when the DVD player is operational.

## Using the DVD Panel

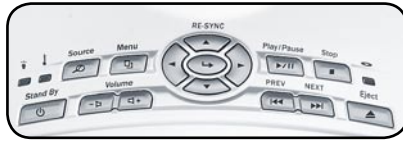

- DVD LED**    Indicate the DVD's status.
- Eject Button**    Stops playing and eject the disc.
- PREV Button**    Press to skip to the previous title/chapter.
- NEXT Button**    Press to skip to the next title/chapter.
- Play/Pause Button**    Press to play/pause playback.
- Stop Button**    Press to stop playback.
- Volume +/-**    Adjusts to increase/decrease the volume.

## On-screen Display Menus

The Projector has multilingual On-Screen Display menus that allow you to make image adjustments and change a variety of settings. The projector will automatically detect the source.

### How to Operate Projector Menu

1. To open the OSD menu, press [Projector Menu] on the Remote Control or press [Menu] on Control Panel.
2. When OSD is displayed, use ◀▶ keys to select any item in the main menu. While making a selection on a particular page, press ▼ key to enter sub menu.
3. Use ▲▼ keys to select the desired item and adjust the settings by ◀▶ key.
4. Select the next item to be adjusted in the sub menu and adjust as described above.
5. Press [Projector Menu]/[Menu] to confirm, and the screen will return to the main menu.
6. To exit, press [Projector Menu]/[Menu] again. If you don't press any key, the projector will automatically disappear after 30 seconds. The OSD menu will close and the projector will automatically save the new settings.

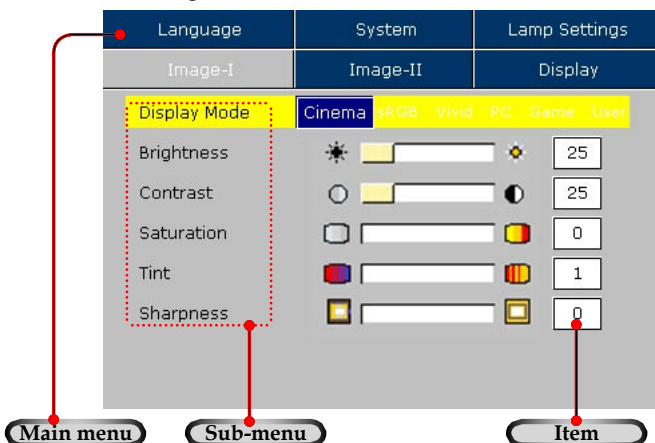

## Menu Tree for Projector

1 English



# USER CONTROLS

English

Image-I	Image-II	Display
Language	System	Lamp Settings
English	繁體中文	
Deutsch	简体中文	
Français	日本語	
Italiano	한국어	
Español	Nederlands	
Русский	Polski	
Suomi	Svenska	
No/Dk		

## Language

### Language

Display a multilingual menu. Use ◀ and ▶ to select your preferred language.

Press [Enter] to finalize the selection.

Language	System	Lamp Settings
Image-I	Image-II	Display
Display Mode	Cinema sRGB Vivid PC Game User	
Brightness		25
Contrast		25
Saturation		0
Tint		1
Sharpness		0

## Image-I

### Display Mode

There are many factory presets optimized for various types of images.

- Cinema: For home theater.
- sRGB: For standard PC colour. (best colour reproduction)
- Vivid: For dynamic frame.
- PC: For computer or notebook. (brightest image)
- Game: For game.
- User: Memorize user's settings.

### Brightness

Adjust the brightness of the image.

- Press ◀ to darken an image.
- Press ▶ to lighten an image.

### Contrast

Contrast controls the degree of difference between the lightest and darkest parts of the picture. Adjusting the contrast changes the amount of black and white with an image.

- Press ◀ to decrease the contrast.
- Press ▶ to increase the contrast.

### Color

Adjust a video image from black and white to fully saturated color.

- Press ◀ to decrease the amount of color in an image.
- Press ▶ to increase the amount of color in an image.

#### Note

The "Color" sub menu is not supported under the analog RGB input source.

# USER CONTROLS

English

## Note

The "Tint" sub menu is not supported under the analog RGB input source.

## Tint

Adjust the color balance of red and green.

- Press ◀ to increase the amount of green in an image.
- Press ▶ to increase the amount of red in an image.

## Sharpness

Adjust the sharpness of an image.

- Press ◀ to decrease the sharpness.
- Press ▶ to increase the sharpness.



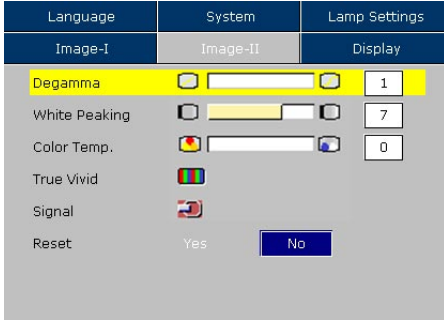

## Image-II

### De gamma

This allows you to choose a degamma table that has been fine-tuned to bring out the best image quality for the input.

### White Peaking

Use the white peaking control to set the white peaking level of the DMD chip. "1" stands for minimal peaking, and "10" stands for maximum peaking. If you prefer a stronger image, adjust toward the maximum setting. For a smoother, more natural image, adjust toward the minimum setting.

### Color Temp.

Adjust the color temperature. The range is from "0" to "2." At a higher temperature, the screen looks colder; at a lower temperature, the screen looks warmer.

### True Vivid

Use ◀ or ▶ to select Red, Green, or Blue for brightness (Offset) and contrast (Gain).

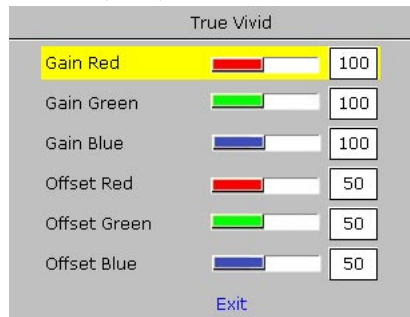

## Signal

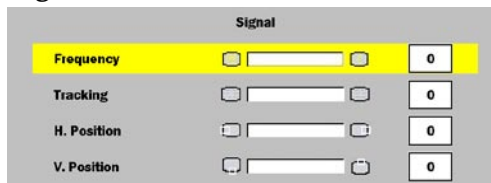

### **Note**

The "Signal" sub menu is supported under the Analog RGB and Analog YPbPr input sources.

- Frequency: Changes the display data frequency to match the frequency of your computer's graphic card. When you experience a vertical flickering bar, use this function to make an adjustment.
- Tracking : Synchronizes the signal timing of the display with the graphics card. If you experience an unstable or flickering image, use this function to correct it.
- Horizontal: Adjusts the horizontal position.
- Vertical: Adjusts the vertical position.

## Reset

Choose "Yes" then "Enter" pressed, the display parameters on this menu will return to their factory default settings.

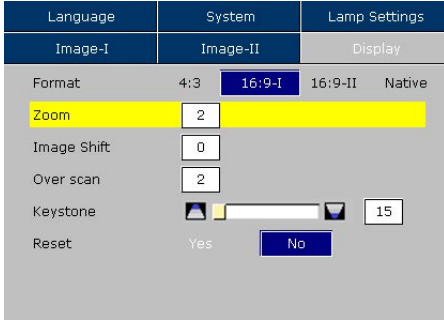

## Display

### Format

- 4:3: The input source will be scaled to fit the projection-screen.
- 16:9-I: The standard wide-screen display format of the projector.
- 16:9-II: The non-standard wide-screen display format of the projector. Part of the original image will be cut if the image aspect ratio is less than 1.67:1.
- Native: The input source will be displayed without scaling.

Source	480i/p	576i/p	720p	1080i	PC
4:3	Scale to 800x600				
16:9-I	Scale to 800x450				
16:9-II	Scale to 854x480, then center 800x480 image to display				
Native	1:1	1:1	800x720 centered	960x540 centered	1:1

### Zoom

Provide different magnification ratios to zoom an image. Image will be centered after zooming.

### Image Shift

Shifts the projected image position vertically. 0 is middle of the screen.

### Overscan

Mask off a few pixels on each edge of the image to be displayed. Use this function to adjust if image source happens to have encoding error near any edge of the displayable image.

# USER CONTROLS

English

## Keystone

Adjust image distortion caused by tilting projector. ( $\pm 16$  degrees)

## Reset

Choose "Yes" then "Enter" pressed, the display parameters on this menu will return to their factory default settings.

Image-I	Image-II	Display
Language	System	Lamp Settings
Menu Location		
Projection		
Signal Type	RGB	Video
Source Lock	On	Off
High Altitude	On	Off
DVD Setup		
Mute	On	Off
Reset	Yes	No

## System

### Menu Location

Choose the menu location on the display screen.

### Projection

#### ■ **Front-Desktop**

The factory default setting.

#### ■ **Rear-Desktop**

When you select this function, the projector reverses the image so you can project from behind a translucent screen.

#### ■ **Front-Ceiling**

When you select this function, the projector turns the image upside down for ceiling-mounted projection.

#### ■ **Rear-Ceiling**

When you select this function, the projector reverses and turns the image upside down. You can project from behind a translucent screen with ceiling mounted projection.

### Signal Type

Select signal type RGB or Video sources.

### Source Lock

When this function is turned off, the projector will search for other signals if the current input signal is lost. When this function is turned on, it will search specific connection port.

### High Altitude

Choose "ON" to turn on High Altitude mode. Operates the fans at full speed continuously to allow for proper high altitude cooling of the projector.

# USER CONTROLS

English

## DVD Setup

Press “Enter” to go to DVD menu.

## Mute

- Choose the “On” to turn mute on.
- Choose the “Off” to turn mute off.

## Reset

Choose “Yes” then “Enter” pressed, the display parameters on this menu will return to their factory default settings.

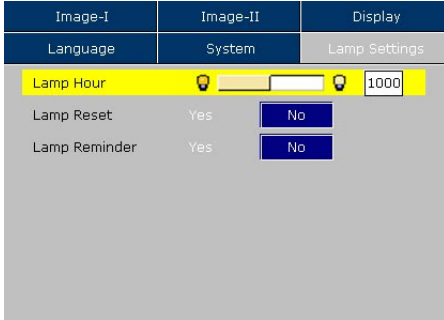

## Lamp Setting

### Lamp Hour

Displays the cumulative lamp operating time.

### Lamp Reset

Reset the lamp setting only when the new lamp is replaced.

### Lamp Reminder

Choose this function to show or to hide the warning message when the changing lamp message is displayed. The message will show up 30 hours before end of life.

## How to Operate WMA/MP3/JPEG Program

1. When you place the MP3/JPEG disc, the DVD player will automatically detect the program.
2. Prioritize to enter the first table of MP3 automatically. And play the first song under this file folder (Cursor suspend in "01" position)
3. Use ◀▶ keys to select the function menu. And the marked icon will turn transparency into full color.
4. Use ▲▼ keys to select the desired track. After the selected star, it will begin to flash.
5. Press [Enter]/[Play] button to play.
6. Press [Return] button to go back the program.
7. To exit program, press [Menu].





## How to Operate DVD Menu

1. To open the DVD OSD menu, press [Projector Menu] on the remote control, go to "System-->DVD Setup".
2. When DVD OSD is displayed, use ◀▶ keys to select any item in the main menu. While making a selection on a particular page, press [Enter] or ▶ key to enter sub menu.
3. Use ▲▼ keys to select the desired item and adjust the settings by ◀▶ key.
4. Select the next item to be adjusted in the sub menu and adjust as described above.
5. Choose the "Exit Setup" to confirm, and the screen will return to the main menu.
6. To exit, press [Setup]/[Enter].

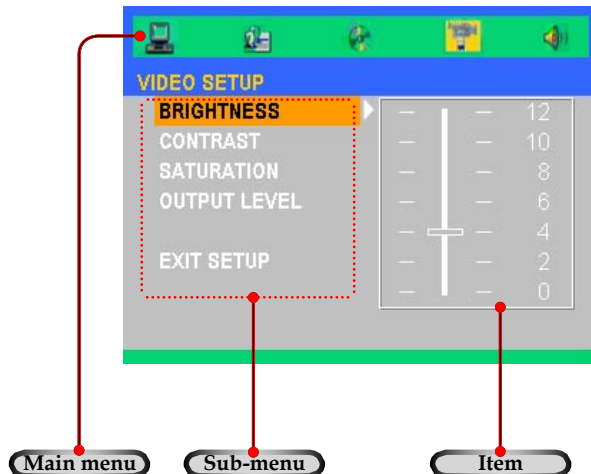

## Menu Tree for DVD

English

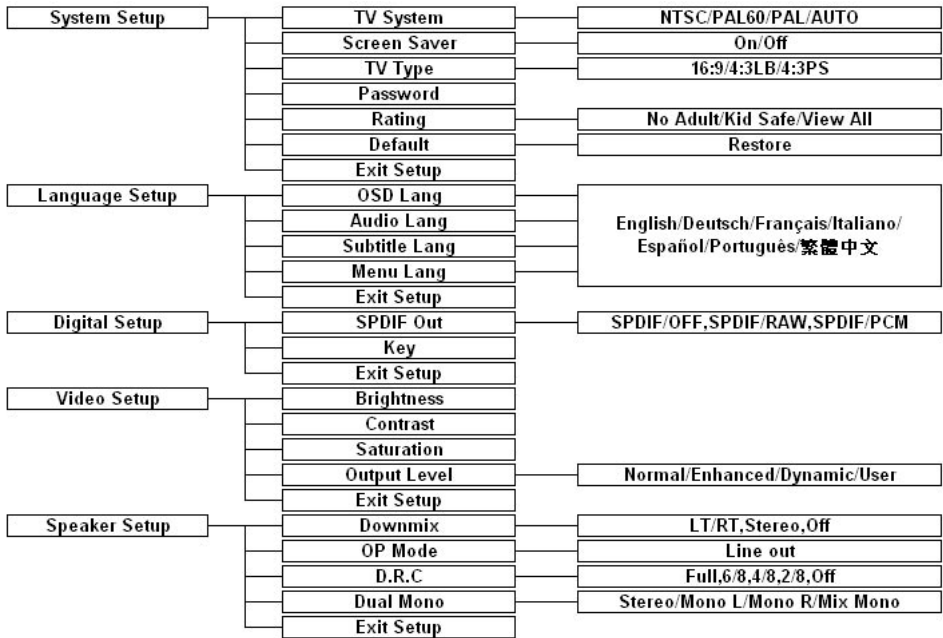

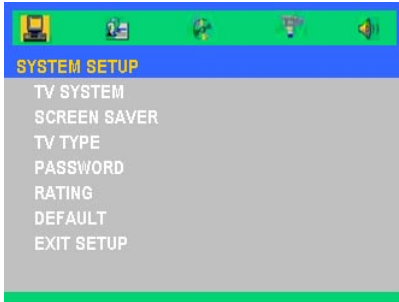

## System Setup

### TV System

Select system as you watching TV.

### Screen Saver

Choose “On” to start the screen protection function, while stopping, opening, no discs or about 60 seconds of picture inactive state on the tray. Choose “Off” to cancel the screen saver function.

### TV Type

Use this function to choose your desired TV type.

1. 16:9 (widescreen): available option for connection with widescreen TV.
2. 4:3LB: (mailbox): suitable for use with standard size TV. In widescreen playback format top and bottom of the screen will display a black band.
3. 4:3PS (full screen scan): suitable for use with standard size TV. In widescreen playback format remove left and right edges then adjust picture to fit full screen.

Note:

- Quality of playback is related to the aspect ratio of the disc. Some discs may not be able to be played on the screen size you choose.
- For discs that are only able to accommodate 4:3 format it doesn't matter what screen ratio you select: playback ratio will always be 4:3.
- Selection of screen ratio should match actual screen ratio of TV being used.

# USER CONTROLS

English

## Note

When you forget the old password, press the initial password "0000".

## Password

The default setting is "Password is locked", can't choose "Rating" or revise the password. If need to select "Rating" to press the numerical key and importing the initial password of the one machine: 0000, then press the enter button to confirm. When you need to change the password, input the old password first, and then input the new password. (The effective password is 4 bits)

## Rating

The "Rating" or "Parental lock" option makes it possible to restrict viewing of certain sequences or entire films to specified age groups.

## Default

Choose "Restore" then "Enter" pressed, the display parameters on all menu will return to their factory default settings.

## Exit Setup

Exit this menu.



## Language Setup

### OSD Language

Select your preferred language for the on-screen display menu.

### Audio Lang

Select the audio language

### Subtitle Lang

Select the subtitle language

### Menu Lang

Select your preferred language for DVD menu.

### Exit Setup

Exit this menu.

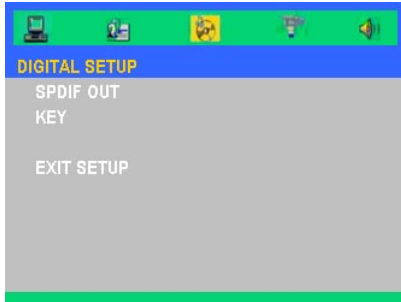

## Digital Setup

### SPDIF Out

Choose the appropriate Digital Audio settings for your equipment as it only affect during the playback of DVD discs of the DVD player.

- SPDIF/Off: Turn off the sound.
- SPDIF/RAW: Select this function, when the player is connected to Dolby Digital Decoder.
- SPDIF/PCM: Select this function, when the player is not connected to Dolby Digital Decoder.

### Key

Adjust the key of sound.

### Exit Setup

Exit this menu.



## Video Setup

### Brightness

Adjust the brightness of the image.

- Press ◀ to darken an image.
- Press ▶ to lighten an image.

### Contrast

Contrast controls the degree of difference between the lightest and darkest parts of the picture. Adjusting the contrast changes the amount of black and white with an image.

- Press ◀ to decrease the contrast.
- Press ▶ to increase the contrast.

### Saturation

Adjust the color balance of red and green.

- Press ◀ to increase the amount of green in an image.
- Press ▶ to increase the amount of red in an image.

### Output Level

There are three factory presets optimized for various types of pictures: Normal, Enhanced, Dynamic and User.

### Exit Setup

Exit this menu.



## Speaker Setup

### Downmix

Depending on the audio channels you got on your audio system. You may decide the Downmix of the channels, whether they are "LT/RT", "Stereo" or "Off".

### OP Mode

- Line out: Carries on the linear compression to the input signal. The volume slightly suits the evening to use.

### D.R.C

Dynamic range decides the pitch of volume. You may set them as "Full", 6/8, 4/8, 2/8 or "Off". To compress the high volume Dolby Digital movie, prevent the sudden high volume sound appeared.

### Dual Mono

Sets the way of audio output for Left and right audio. You may set them as the "Stereo", "Mono L", "Mono R" or "Mix Mono".

### Exit Setup

Exit this menu.



## Troubleshooting

*If you experience a problem with your projector, please refer to the following information. If a problem persists, please contact your local reseller or service center.*

### Image Problems

#### **? No image appears on screen:**

- Ensure that all the cables and power cord are correctly and securely connected as described in the “Installation” section.
- Ensure that connector pins are not bent or broken.
- Check the [Power] or [Stand By] button is pressed.
- Make sure that the projection lamp has been securely installed. Please refer to the “Replacing the lamp” section.
- Ensure that you have removed the lens cap and that the projector is powered on.

#### **Note**

The Resync function can not be used when the DVD player is operational.

#### **? Partial, scrolling, or incorrectly displayed images:**

- Press [Re-Sync] on the control panel.
- If using a PC:

#### **For Windows 95, 98, 2000, XP:**

1. From the “My Computer” icon, open the “Control Panel” folder, and double click the “Display” icon.
2. Select the “Settings” tab.
3. Verify that your display resolution setting is lower than or equal to 1280 x 1024.
4. Click on the “Advanced Properties” button.

**If the projector is still not projecting the whole image, you will also need to change the monitor display you are using. Refer to the following steps.**

5. Verify the resolution setting is lower than or equal to 1280 x 1024.

6. Select the “Change” button under the “Monitor” tab.
  7. Click on “Show all devices.” Next, select “Standard monitor types” under the SP box; choose the resolution mode you need under the “Models” box.
  8. Verify that the resolution setting of the monitor display is lower than or equal to 1280 x 1024.
- If using a Notebook PC:
    1. First, follow the steps above to adjust resolution of the computer.
    2. Press the toggle output settings. example: [Fn]+[F4]

Compaq=>	[Fn]+[F4]	Hewlett	=>	[Fn]+[F4]
Dell =>	[Fn]+[F8]	Packard	=>	[Fn]+[F4]
Gateway=>	[Fn]+[F4]	NEC=>		[Fn]+[F3]
IBM=>	[Fn]+[F7]	Toshiba =>		[Fn]+[F5]

Mac Apple:  
System Preference-->Display-->Arrangement-->Mirror display

- If you experience difficulty changing resolutions or your monitor freezes, restart all the equipment including the projector.

## **? The screen of the Notebook or PowerBook computer is not displaying your presentation:**

**If using a Notebook PC:**

Some Notebook PCs may deactivate their own screens when a second display device is in use. Each has a different way of reactivating. Refer to your computer’s documentation for detailed information.

## **? Image is unstable or flickering:**

- Use “Tracking” to correct it. See page 34 for more information.
- Change the monitor color setting on your computer.

## **? Image has a vertical flickering bar:**

- Use “Frequency” to make an adjustment. See page 34 for more information.
- Check and reconfigure the display mode of your graphics card to ensure compatibility.

## ? Image is out of focus:

- Make sure the lens cap is removed.
- Make sure the projection screen is between the required distance 4.92 to 32.8 feet (1.5 to 10.0 meters) from the projector.

## ? Image is too small or too large:

- Adjust the zoom lever on the top of the projector.
- Move the projector closer to or farther from the screen.
- Press [4:3] / [16:9-I] / [16:9-II] / [Native] button on the remote control or [Projector menu] on the projector panel, go to "Display->Format". Try the different settings.

## ? Image has slanted sides:

- As possible, reposition the projector so that it is centered on the screen and below the bottom of the screen.
- Press [Keystone +/-] button until the sides are vertical on the remote control.

## ? Image is reversed:

- Select "System-->Projection" from the OSD and adjust the projection direction.

## Projector Operation Problems

### ? The projector stops responding to all controls:

- If possible, turn off the projector, then unplug the power cord and wait at least 20 seconds before reconnecting power.

### ? Lamp burns out or makes a popping sound:

- When the lamp reaches its end of life, it will burn out and may make a loud popping sound. If this happens, the projector will not turn on until the lamp module has been replaced. To replace the lamp, follow the procedures in the "Replacing the Lamp" section on page 55.

## LED Problems

### ? LED lighting message:

**Note**

Steady light => ☀  
No light => ○

Message	Power LED		DVD LED (Green)	Temp LED (Orange)	Lamp LED (Orange)
	(Blue)	(Green)			
Standby State (Input power cord)	Flashing		○	○	○
Standby State (Play DVD)	Flashing		☀	○	○
Standby State (Burn in Mode)	Flashing		○	☀	☀
Power On/Lamp lighting		☀	○	○	○
Lamp lighting (DVD Playing)		☀	☀	○	○
Power Off/ Cooling		Flashing	○	○	○
Error (Overheated)		☀	○	☀	○
Error (Fan Failed)		☀	○	Flashing	○
Error (Lamp Failed)		☀	○	○	☀
Error (Photo Sensor Failed)		☀	○	Flashing	○
Error (Color Wheel Senser Failed)		☀	○	○	Flashing

## ? Message Reminders

- Replacing the lamp:

Lamp is approaching the end of its useful life in full power operation.  
Replacement suggested!

- Over temperature:

Projector Overheated  
Projector will automatically turn off.

- Fan failed:

Fan Failure  
Lamp will automatically turn off.

## DVD Player Problems

### ? If a message shows an error message:

- Make sure the disc is inserted with the label facing up.
- Ensure disc is clean, in good condition and is not scratched.

- The type of disc you inserted might not be supported by the internal DVD player. If so, you can not play this type of disc. Try a different disc.
- For a DVD, check its region code. Most DVDs have a region code marked near the center hole. Compare its region code with the region code for a DVD that plays properly on your projector. The projector can play DVDs from only one region.

## **? If a disc does not automatically play:**

- A disc automatically starts playing only at the time you insert the disc. If a disc is already loaded in the loader, press the [Play] button to start playing.
- Make sure the [Power] or [Stand By] button is pressed. If the projector is powered off, nothing happens to the internal DVD player.

## **? If a disc skips and does not continuously play:**

- Check the DVD player isn't in [A-B] repeat status.
- Make sure the disc is completeness, not scratch, dirtiness or warp. If so, try to clean disc or press [Goto] button to skip to next chapter or title.

## **? If some images on a CD do not show:**

- Some images with very high resolution (high number of pixels) cannot be displayed. Convert them to standard format with a lower resolution.

## Sound Problems

### **? If no sound from the projector:**

- If you are playing an external source, make sure you have an audio cable securely connected between the source device and the projector's audio input.
- Make sure the headphone is not connected.
- Make sure the volume is not set to minimum.
- Make sure the "Audio Setup-->SPDIF Out" function is not set to "SPDIF/Off".
- Make sure the "System-->Mute" function is set to "Off".
- Make sure the DVD player is not in pause status.

## Remote Control Problems

### If the remote control does not work:

- Check the operating angle for the remote control is approximately  $\pm 30^\circ$  horizontally and approximately  $\pm 15^\circ$ .
- Make sure there are not any obstructions between the remote control and the projector. Move to within 6 m (20 ft) of the projector.
- Make sure batteries are inserted correctly.
- Make sure batteries are exhausted. If so, replace weak batteries in the remote control.

## Replacing the Lamp

The projector automatically detects the lamp life. When the lamp life is nearing the end of use, you will receive a warning message.

Lamp is approaching the end of its useful life in full power operation.

Replacement suggested!

When you see this message, please contact your local reseller or service center to change the lamp as soon as possible. Make sure the projector has been cooled down for at least 30 minutes before changing the lamp.



**Warning:** Lamp compartment is hot! Allow it to cool down before changing lamp!

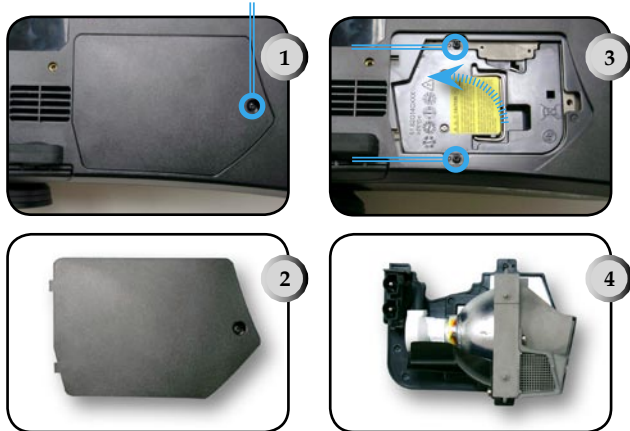

**Warning:** To reduce the risk of personal injury, avoid dropping the lamp module or touching the lamp bulb. If dropped, the bulb may shatter and cause injury.

### Lamp Replacing Procedure:

1. Turn off the power to the lamp by pressing the [Power] or [Stand By] button.
2. Allow the projector to cool down at least 30 minutes.
3. Disconnect the power cord.
4. Use screwdriver to remove the screw from the cover. ❶
5. Remove the cover. ❷
6. Unscrew 2 screws from the lamp module. ❸
7. Pull out the lamp module. ❹

**To replace the lamp module, reverse the above mentioned steps.**

## Compatibility Modes

Mode	Resolution	(ANALOG)	
		V.Frequency (Hz)	H.Frequency (kHz)
VESA VGA	640 x 350	70	31.46
VESA VGA	640 x 400	60	31.46
VESA VGA	640 x 480	60	31.46
VESA VGA	640 x 480	72	37.86
VESA VGA	640 x 480	75	37.50
VESA VGA	640 x 480	85	43.26
VESA VGA	720 x 400	70	31.46
VESA VGA	720 x 400	85	37.92
VESA SVGA	800 x 600	56	35.15
VESA SVGA	800 x 600	60	37.87
VESA SVGA	800 x 600	72	48.07
VESA SVGA	800 x 600	75	46.87
VESA SVGA	800 x 600	85	53.67
* VESA XGA	1024 x 768	60	48.36
* VESA XGA	1024 x 768	70	56.47
* VESA XGA	1024 x 768	75	60.02
* VESA XGA	1024 x 768	85	68.67
* VESA SXGA	1280 x 1024	60	64.31
MAC G4	640 x 480	60	31.40
MAC G4	640 x 480	72	37.41
MAC G4	640 x 480	75	37.5
MAC G4	640 x 480	85	43.26
MAC G4	800 x 600	56	35.15
MAC G4	800 x 600	60	37.81
MAC G4	800 x 600	72	48.13
MAC G4	800 x 600	75	46.87
MAC G4	800 x 600	85	53.67
* MAC G4	1024 x 768	60	48.27
* MAC G4	1024 x 768	70	56.47
* MAC G4	1024 x 768	75	60.2
* MAC G4	1024 x 768	85	68.67
* MAC G4	1152 x 870	75	68.76

**Note**

Remark: "\*" compressed computer image.



## Ceiling Mount Installation

1. To prevent damaging your projector, please use the ceiling mount package for installation.
2. If you wish to use a third party ceiling mount kit, please ensure the screws used to attached a mount to the projector met the following specifications:

- ▶ **Screw type: M3**
- ▶ **Maximum screw length: 10mm**
- ▶ **Minimum screw length: 7.5mm**

### Note

Please note that damage resulting from incorrect installation will invalidate the warranty.



### Warning:

1. If you buy the ceiling mount from other company, please ensure that there is at least 10cm distance between the bottom cover of the projector and the ceiling.
2. Avoid placing the projector near sources of heat such air-conditioning units and heaters otherwise it may overheat and shut down automatically.
3. Ceiling mounting shall be mounting on metal or concrete.

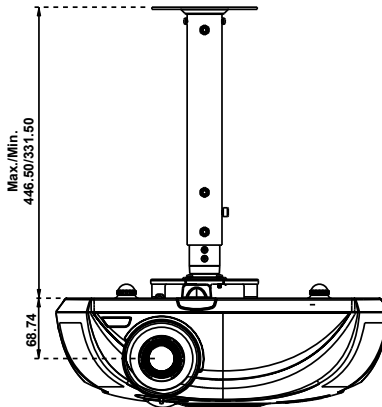
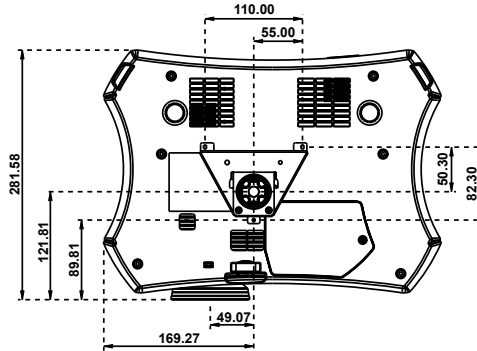

## Optoma Global Offices

*For service or support please contact your local office.*

### USA

715 Sycamore Drive  
Milpitas, CA 95035, USA  
[www.optomausa.com](http://www.optomausa.com)

Tel : 408-383-3700  
Fax: 408-383-3702  
Service : [service@optoma.com](mailto:service@optoma.com)

### Canada

5630 Kennedy Road, Mississauga,  
ON, L4Z 2A9, Canada  
Tel : 905-882-4228  
[www.optoma.com](http://www.optoma.com)

Fax: 905-882-4229

### Europe

42 Caxton Way, The Watford Business Park  
Watford, Hertfordshire, WD18 8QZ, UK

Tel : +44 (0) 1923 691 800

Fax: +44 (0) 1923 691 888

[www.optomaeurope.com](http://www.optomaeurope.com)

Service Tel : +44 (0)1923 691865

Service : [service@tsc-europe.com](mailto:service@tsc-europe.com)

### Taiwan

5F., No. 108, Minchiuan Rd.  
Shindian City, Taipei Taiwan 231,  
R.O.C.

Service : [services@optoma.com.tw](mailto:services@optoma.com.tw)

Tel : +886-2-2218-2360

Fax: +886-2-2218-2313

[www.optoma.com.tw](http://www.optoma.com.tw)

[asia.optoma.com](http://asia.optoma.com)

### Hong Kong

Room 2507, 25/F., China United Plaza, No. 1008 Tai Nan West Street,  
Lai Chi Kok, Kowloon, Hong Kong

Tel : +852-2396-8968

Fax: +852-2370-1222

[www.optoma.com.hk](http://www.optoma.com.hk)

### China

5F, No. 1205, Kaixuan Rd.,  
Changning District  
Shanghai, 200052, China

Tel : +86-21-62947376

Fax: +86-21-62947375

[www.optoma.com.cn](http://www.optoma.com.cn)

### Latin America

715 Sycamore Drive  
Milpitas, CA 95035, USA  
[www.optoma.com.br](http://www.optoma.com.br)

Tel : 408-383-3700

Fax: 408-383-3702

[www.optoma.com.mx](http://www.optoma.com.mx)

## Regulation & safety notices

*This appendix lists the general notices of your Projector.*

### *FCC notice*

This device has been tested and found to comply with the limits for a Class B digital device pursuant to Part 15 of the FCC rules. These limits are designed to provide reasonable protection against harmful interference in a residential installation. This device generates, uses, and can radiate radio frequency energy and, if not installed and used in accordance with the instructions, may cause harmful interference to radio communications.

However, there is no guarantee that interference will not occur in a particular installation. If this device does cause harmful interference to radio or television reception, which can be determined by turning the device off and on, the user is encouraged to try to correct the interference by one or more of the following measures:

- Reorient or relocate the receiving antenna.
- Increase the separation between the device and receiver.
- Connect the device into an outlet on a circuit different from that to which the receiver is connected.
- Consult the dealer or an experienced radio/television technician for help.

### ***Notice: Shielded cables***

All connections to other computing devices must be made using shielded cables to maintain compliance with FCC regulations.

### ***Caution***

Changes or modifications not expressly approved by the manufacturer could void the user's authority, which is granted by the Federal Communications Commission, to operate this computer.

## *Operation conditions*

This device complies with Part 15 of the FCC Rules. Operation is subject to the following two conditions:

- 1.this device may not cause harmful interference, and
- 2.this device must accept any interference received, including interference that may cause undesired operation.

## *Notice: Canadian users*

This Class B digital apparatus complies with Canadian ICES-003.

## *Remarque à l'intention des utilisateurs canadiens*

Cet appareil numérique de la classe B est conforme a la norme NMB-003 du Canada.

## *Declaration of Conformity for EU countries*

- EMC Directive 89/336/EEC (including amendments)
- Low Voltage Directive 73/23/EEC (amended by 93/68/EEC)
- R & TTE Directive 1999/EC (if product has RF function)