



# Table of Contents

<b>Usage Notice</b> .....	2
Safety Information .....	2
Class B emissions limits.....	2
Important Safety Instruction.....	2
Precautions.....	4
Eye Safety Warnings.....	6
<b>Introduction</b> .....	7
Product Features .....	7
Package Overview .....	8
Product Overview .....	9
Main Unit.....	9
Control Panel.....	10
Rear View.....	11
Remote Control .....	12
<b>Installation</b> .....	13
Connecting the Projector.....	13
Connect to Computer / Notebook.....	13
Connect to Video Sources.....	14
Installing or Removing the Optional Lens .....	15
Removing the Existing Lens From the Projector.....	15
Installing the New Lens.....	16
Powering On/Off the Projector .....	17
Powering On the Projector.....	17
See Security Setting on page 43 if security lock is enabled.....	18
Powering Off the Projector.....	19
Warning Indicator.....	19
Adjusting the Projected Image.....	20
Adjusting the Projector's Height.....	20
Adjusting Projected Image Position Using PureShift .....	20
Adjusting the vertical image position.....	21
Adjusting the horizontal image position.....	22
PureShift Range Diagram.....	22
Adjusting the Zoom / Focus.....	23
Adjusting Projection Image Size (XGA).....	24
Adjusting Projection Image Size (WXGA).....	25
<b>User Controls</b> .....	26
Control Panel.....	26
Remote Control .....	27
On-screen Display Menus.....	29
How to operate.....	29
Menu Tree.....	30
Image .....	31
Display.....	37
Setup .....	39
Options .....	50
LAN_RJ45.....	55
<b>Appendices</b> .....	58
Troubleshooting/Help On-screen Display Menu.....	58
Image Problems.....	58
Intermission Problems .....	63
HDMI Q & A .....	64
Projector Status Indication.....	65
LED Error Code Messages.....	66
Remote Control Problems .....	67
Audio Problems.....	68
Replacing the Lamp.....	69
Cleaning the Projector .....	71
Cleaning the Lens.....	71
Cleaning the Case .....	71
Compatibility Modes.....	72
RS232 Commands .....	74
RS232 Protocol Function List.....	75
Ceiling Installation.....	82
Optoma Global Offices.....	83
Regulation & Safety notices.....	85
Operation conditions.....	86

## Safety Information

	The lightning flash with arrow head within an equilateral triangle is intended to alert the user to the presence of uninsulated “dangerous voltage” within the product’s enclosure that may be of sufficient magnitude to constitute a risk of electric shock to persons.
	The exclamation point within an equilateral triangle is intended to alert the user to the presence of important operating and maintenance (servicing) instructions in the literature accompanying the appliance.

WARNING: TO REDUCE THE RISK OF FIRE OR ELECTRIC SHOCK, DO NOT EXPOSE THE PROJECTOR TO RAIN OR MOISTURE. DANGEROUS HIGH VOLTAGES ARE PRESENT INSIDE THE ENCLOSURE. DO NOT OPEN THE CABINET.

REFER SERVICING TO QUALIFIED PERSONNEL ONLY.

### Class B emissions limits

This Class B digital apparatus meets all requirements of the Canadian Interference-Causing Equipment Regulations.

### Important Safety Instruction

1. Read these instructions –before using this projector.
2. Keep these instructions –for future reference.
3. Follow all instructions.
4. Install in accordance with the manufacturer’s instructions :
  - A. **Do not block any ventilation openings.** To ensure reliable operation of the projector and to protect it from overheating, put the projector in a position and location that will not interfere with its proper ventilation. For example, do not place the projector on a bed, sofa, carpet, or similar surface that may block the ventilation openings. Do not put it in an enclosure, such as a bookcase or a cabinet that may keep air from flowing through its ventilation openings.
  - B. **Do not use this projector near water or moisture.** To reduce the risk of fire or electric shock, do not expose the projector to rain or moisture.
  - C. **Do not install near any heat sources**, such as radiators, heaters, stoves or other apparatus (including amplifiers) that produce heat.
5. Clean only with a dry cloth.
6. Only use attachments/ accessories specified by the manufacturer.
7. Refer all servicing to qualified service personnel. Servicing is required when the projector has been damaged in any way, such as:
  - Power supply cord or plug is damaged.
  - Liquids have spilled or objects have fallen into the apparatus.
  - The projector has been exposed to rain or moisture, does not operate normally, or has been dropped.



# *Usage Notice*

Do not attempt to service this projector yourself. Opening or removing covers may expose you to dangerous voltages or other hazards. Please call Optoma to be referred to an authorized service center near you.

8. Do not let objects or liquids enter the projector as they may touch dangerous voltage points or short-out parts that could result in a fire or electric shock.
9. See projector enclosure for safety related markings.
10. The projector should not be adjusted or repaired by anyone except properly qualified service personnel.

## Precautions



*Please follow all warnings, precautions and maintenance as recommended in this user's guide.*



❖ When the lamp reaches the end of its life, the projector will not turn back on until the lamp module has been replaced. To replace the lamp, follow the procedures listed under "Replacing the Lamp" section on page 69.

- ■ Warning - Do not look into the projector's lens when the lamp is on. The bright light may damage your eyes.
- ■ Warning - To reduce the risk of fire or electric shock, do not expose this projector to rain or moisture.
- ■ Warning - Please do not open or disassemble the projector as this may cause electric shock.
- ■ Warning - When replacing the lamp, please allow unit to cool down, and follow all replacement instructions. See pages 69.
- ■ Warning - This projector will detect the life of the lamp itself. Please be sure to change the lamp when it shows warning messages.
- ■ Warning - Use the "Lamp Reset" function from the on-screen display "Options | Lamp Setting" menu after replacing the lamp module (see page 53).
- ■ Warning - When switching the projector off, please ensure the cooling cycle has been completed before disconnecting the power. Allow 90 seconds for the projector to cool down.
- ■ Warning - Do not use the lens cap when projector is in operation.
- ■ Warning - When the lamp is approaching the end of its life, the message "Lamp is approaching the end of its useful life" displays on the screen. Please contact your local reseller or service center to change the lamp as soon as possible.
- ■ Warning - To reduce the risk of injury to the eyes, do not look directly into the laser beam on the remote control and do not point the laser beam into anyone's eyes. This remote control is equipped with a Class II laser that emits radiation.

## Do:

- ❖ Turn off the product before cleaning.
- ❖ Use a soft cloth moistened with a mild detergent to clean the display housing.
- ❖ Disconnect the power plug from the AC outlet if the product is not being used for a long period of time.

## Do not:

- ❖ Block the ventilation slots and openings on the unit.
- ❖ Use abrasive cleaners, waxes or solvents to clean the unit.
- ❖ Use under the following conditions:
  - In extremely hot, cold or humid environments. Ensure that the ambient room temperature is within 5-40 °C and relative humidity is 10-85% (max.), non-condensing.
  - In areas susceptible to excessive dust and dirt.
  - Near any appliance that generates a strong magnetic field.
  - In direct sunlight.

## Eye Safety Warnings



- ■ Avoid staring directly into the projector's beam of light at all times.
- ■ Minimize standing facing into the beam. Keep your back to the beam as much as possible.
- ■ Using a stick or laser pointer is recommended to avoid the need for the presenter to enter the beam.
- ■ Ensure that projectors are located out of the line of sight from the screen to the audience; this ensures that, when presenters look at the audience, they do not also have to stare at the projector lamp. The best way to achieve this is by ceiling-mounting the projector rather than placing it on floor or table top.
- ■ When projector is used in a classroom, adequately supervise students when they are asked to point out something on the screen.
- ■ In order to minimize the lamp power needed, use room blinds to reduce ambient light levels.

## Product Features

This product is a single chip 0.7" XGA and 0.65" WXGA series DLP® projector. Outstanding features include:

- ◆ Texas Instruments Single chip DLP® Technology
- ◆ Computer Compatibility:
  - Apple Macintosh, iMac, and VESA Standards:  
UXGA, SXGA+, SXGA, WXGA, WUXGA, XGA, SVGA, VGA
- ◆ Video Compatibility:
  - NTSC, NTSC4.43
  - PAL/PAL-M/PAL-N/SECAM
  - SDTV and EDTV compatible
  - HDTV compatible (720p, 1080i, 1080p)
- ◆ Auto source detection with user definable settings
- ◆ Fully featured IR remote control with laser pointer and mouse control
- ◆ User friendly multilingual On Screen Menu
- ◆ Advanced digital keystone correction and high quality full screen image re-scaling
- ◆ User friendly control panel
- ◆ Two built-in speakers with 3 Watt amplifier
- ◆ Macintosh and PC compatible
- ◆ HDMI 1.3 compatible
- ◆ Instant On Screen Help
- ◆ Closed Captioning equipped

## Package Overview

This projector comes with all the items shown below. Check to make sure your unit is complete. Contact your dealer immediately if anything is missing.



Projector with lens cap

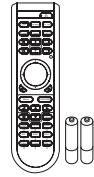

IR Remote Control  
(with 2 x AA Batteries)



Option Lens  
(Standard lens/  
Long throw lens/  
Short throw lens)

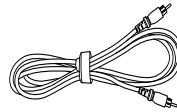

Composite Cable  
1.8m  
(Not available in  
European Version)

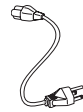

Power Cord 1.8m



❖ Due to the difference in applications for each country, some regions may have different accessories.

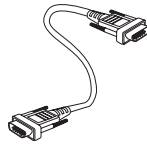

VGA Cable 1.8m

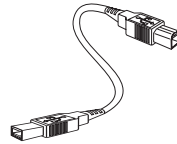

USB Cable  
(A to B) 1.8m  
(optional)

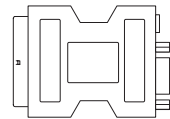

SCART to RGB &  
S-Video Adapter  
(optional)

### Documentation:

- User's Manual
- Warranty Card
- Quick Start Card
- WEEE Card



## Product Overview Main Unit

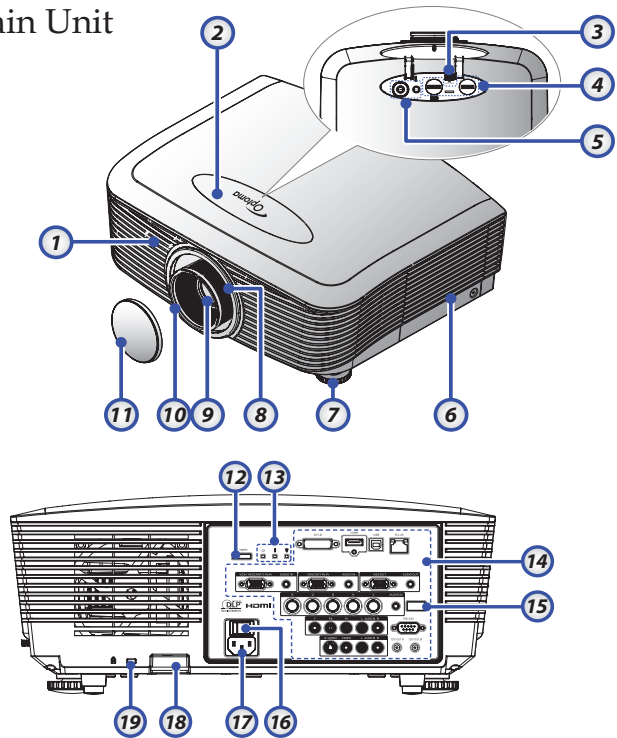

- |   |                              |
|---|------------------------------|
| 1. Front IR Receiver                                      | 10. Focus                    |
| 2. Top Cover  | 11. Lens CAP                 |
| 3. Lens Release Button                                    | 12. Power Button             |
| 4. Vertical and Horizontal Lens Shift Adjustment Controls | 13. LED Indicators           |
| 5. Control Panel  | 14. Input/Output Connections |
| 6. Lens Cover   | 15. Back IR Receiver         |
| 7. Tilt-Adjustment foot                                   | 16. Power Switch             |
| 8. Zoom   | 17. Power Socket             |
| 9. Lens   | 18. Security Chain Lock      |
|   | 19. Kensington™ Lock         |

## Control Panel

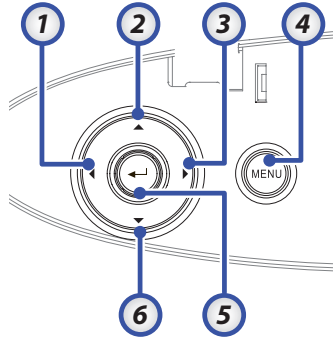

1. Source / ◀
2. Keystone + / ▲
3. Re-Sync / ▶
4. Menu
5. Enter / Help  
(See page 58 Appendices for help function.)
6. Keystone - / ▼

## Rear View

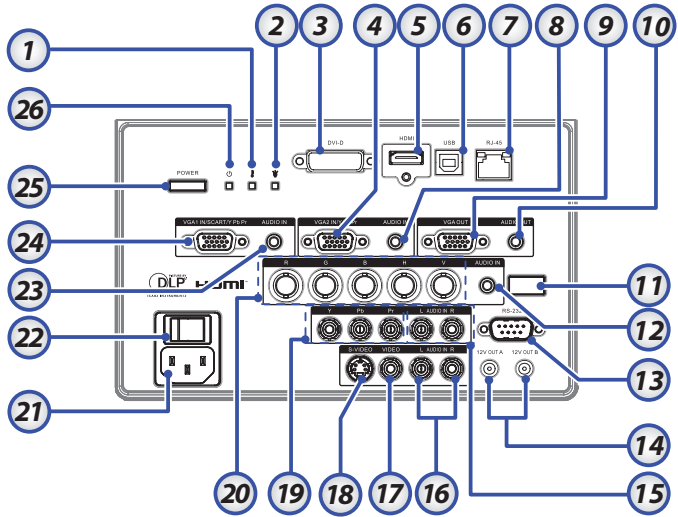

- |                           |                                   |
|---------------------------|-----------------------------------|
| 1. Temp LED               | 14. 12V OUT A/B Connector         |
| 2. Lamp LED               | 15. AUDIO IN L/R RCA Connectors   |
| 3. DVI-D Connector        | 16. AUDIO IN L/R RCA Connectors   |
| 4. VGA 2/ YPbPr Connector | 17. VIDEO Connector               |
| 5. HDMI Connector         | 18. S-VIDEO Connector             |
| 6. USB Connector          | 19. YPbPr Connectors              |
| 7. RJ-45 Connector        | 20. BNC Connectors                |
| 8. AUDIO IN Connector     | 21. Power Socket                  |
| 9. VGA OUT                | 22. Power Switch                  |
| 10. AUDIO OUT 3.5mm Jack  | 23. AUDIO IN Connector            |
| 11. Back IR Receiver      | 24. VGA 1/ SCART/ YPbPr Connector |
| 12. AUDIO IN Connector    | 25. Power Button                  |
| 13. RS-232 Connector      | 26. Power LED                     |

# Introduction

## Remote Control

1. AV Mute
2. Power On/Off
3. Re-Sync
4. Freeze
5. Keystone
6. Page Up
7. Volume +/-
8. Page Down
9. PC/Mouse control
10. Mouse Right Click
11. Enter/Help
12. Four Directional Select Keys
13. Format/1 (Number Button for password input)
14. Source/4
15. Component/3
16. VGA-1/7
17. VGA-2/0
18. S-Video/9
19. BNC/6
20. Video/8
21. DVI/5
22. HDMI/2
23. Brightness
24. Menu
25. Mouse Left Click
26. Zoom Out
27. Zoom In
28. Display
29. Laser Pointer



❖ Due to the difference in applications for each country, some regions may have different accessories.

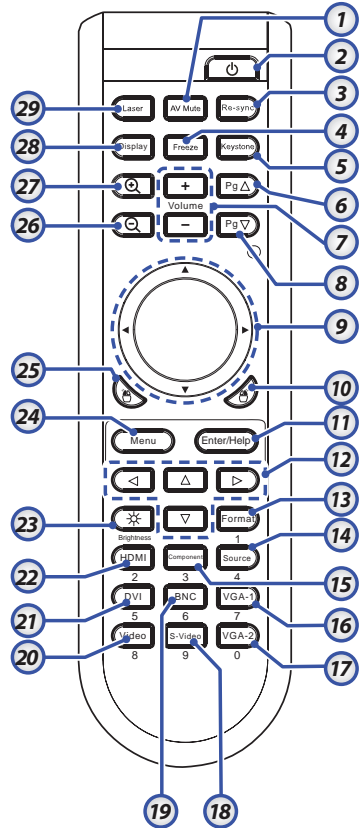

## Connecting the Projector Connect to Computer / Notebook

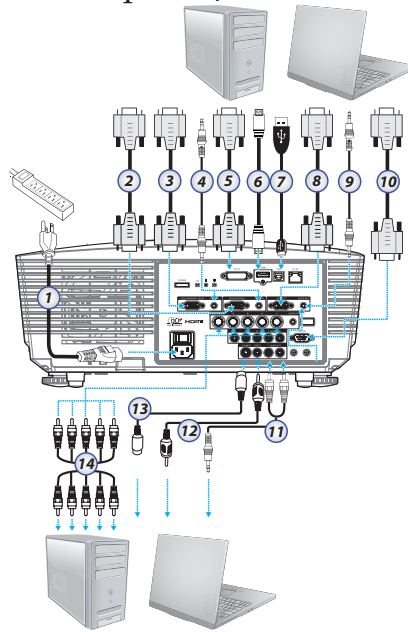

❖ Due to the difference in applications for each country, some regions may have different accessories.

1. Power Cord
2. VGA2 Cable
3. VGA1 Cable
4. Audio-in Cable
5. DVI-D Cable (Optional)
6. HDMI Cable (Optional)
7. USB Cable
8. VGA-out Cable (Available for VGA1 VGA signal loop through)
9. Audio-out (Optional RCA to 3.5mm jack cable)
10. RS-232 Cable (Optional)
11. Audio-in Cable
12. Video Cable
13. S-Video Cable
14. BNC Cable

## Connect to Video Sources



❖ Due to the difference in applications for each country, some regions may have different accessories.

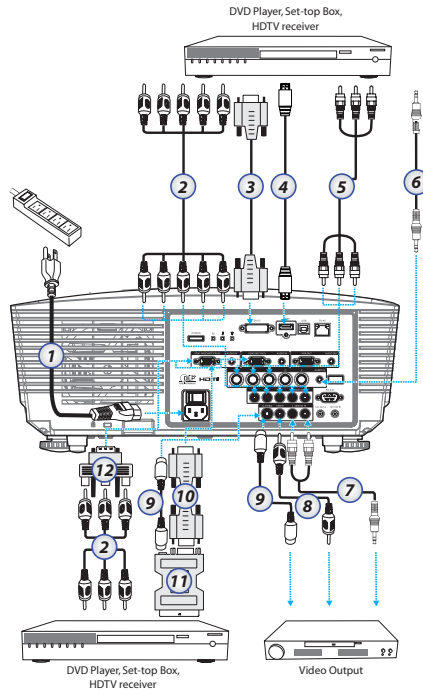

1. Power Cord
2. Component Cable (Optional)
3. DVI-D Cable (Optional)
4. HDMI Cable (Optional)
5. BNC Cable (Optional)
6. Audio-in Cable
7. Audio-in Cable
8. Video Cable (Optional)
9. S-Video Cable (Optional)
10. VGA Cable
11. SCART to RGB & S-Video Adapter (Optional)
12. RGB to Component Adapter (Optional)

## Installing or Removing the Optional Lens

### Caution

- Do not shake or place excessive pressure on the projector or the lens components as the projector and lens components contain precision parts.
- Before removing or installing the lens, be sure to turn off the projector, wait until the cooling fans stop, and turn off the main power switch.
- Do not touch the lens surface when removing or installing the lens.
- Keep fingerprints, dust or oil off the lens surface. Do not scratch the lens surface.
- Work on a level surface with a soft cloth under it to avoid scratching.
- If you remove and store the lens, attach the lens cap to the projector to keep off dust and dirt.

### Removing the Existing Lens From the Projector

1. Push down and release the top cover to open.
2. Push the LENSE RELEASE button to the unlock position.
3. Grasp the lens.
4. Rotate the lens counterclockwise. The existing lens will be disengaged.

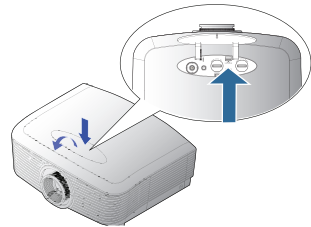

# Installation

5. Pull out the existing lens slowly.

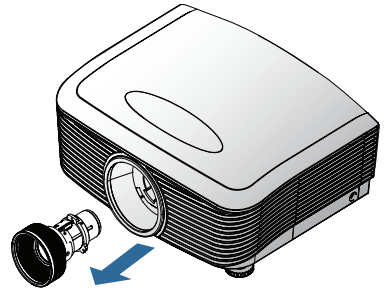

## Installing the New Lens



❖ Pin of IRIS should be in the direction as shown in the picture.

1. Align the notches and correctly position the electrical contact pad as shown in the picture.

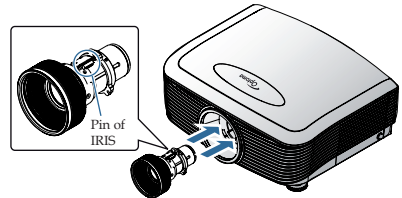

2. Rotate the lens clockwise until you feel it click into place.

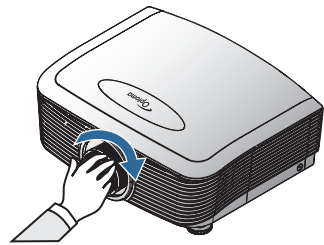



## Powering On/Off the Projector

### Powering On the Projector

1. Remove the lens cover.
2. Connect the power cord to the projector.
3. Turn On the connected devices.
4. Ensure the Power LED turns amber and then press the power button to turn On the projector.  
The Power LED will now flash blue.



- ❖ Turn on the projector first and then select the signal sources. First time to turn on the projector: Remember to select the type of lens you have installed. Detail see page 51.

The startup screen will display in approximately 30 seconds. The first time you use the projector, you can select your preferred language and Power Mode setup after the startup screen display.



If the connected device is a PC, press the appropriate keys on the computer keyboard to switch the display output to the projector. (Check the user manual of the PC to determine the appropriate Fn key combination to change display output.)

# Installation

See Security Setting on page 43 if security lock is enabled.



5. If more than one input device is connected, press the “Source” button sequentially to switch between devices.  
For direct source selection, see page 28.



## Powering Off the Projector

1. Press **POWER** to turn off the projector lamp, a message displays on the projector's screen.

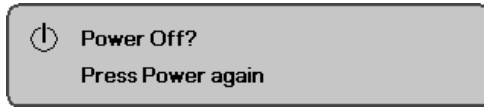

2. Press **POWER** again to confirm, otherwise the message disappears after 15 seconds.
3. The cooling fans continue to operate for about 10 seconds for cooling cycle and the Power Led will turn blue. When the light is solid amber, the projector has entered standby mode.  
(If you wish to turn the projector back on, you must wait until the projector has completed the cooling cycle and has entered standby mode. Once in standby mode, simply press **POWER** to restart the projector.)
4. Turn off the main power switch. Disconnect the power cord from the electrical outlet and the projector.
5. Do not turn on the projector immediately following a power off procedure.

## Warning Indicator

- ❖ When the LAMP LED indicator lights red, the projector will automatically shut itself down. Please contact your local reseller or service center. See pages 65-67.
- ❖ When the TEMP LED is on a steady (not flashing) red, the projector will automatically shut itself down. Under normal conditions, the projector can be switched on again after it has cooled down. If the problem persists, you should contact your local dealer or our service center. See pages 65-67.
- ❖ When the TEMP LED flashes red, it indicates the fan has failed. Please contact your local dealer or our service center. See pages 65-67.

## Adjusting the Projected Image Adjusting the Projector's Height

The projector is equipped with elevator foot for adjusting the image height.

### To raise the image:

Use screw in foot ❶ to rise the image to the desired height angle and fine-tune the display angle.

### To lower the image:

Use screw in foot ❶ to lower the image to the desired height angle and to fine-tune the display angle.

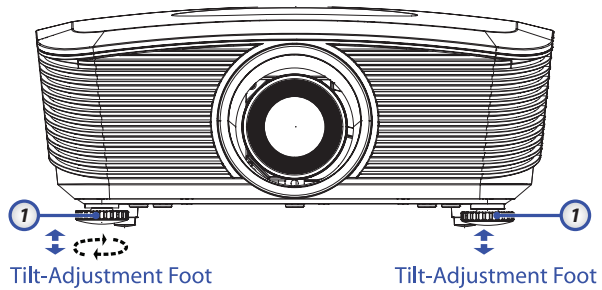

## Adjusting Projected Image Position Using PureShift

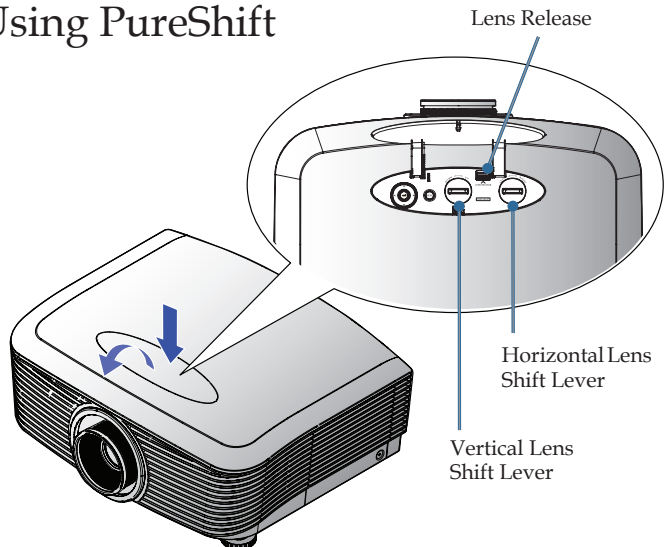

The PureShift feature provides a lens shift function that can be used to adjust the position of the projected image either horizontally or vertically within the range detailed below.

PureShift is a unique system that provides lens shift while maintaining a much higher ANSI contrast ratio than traditional lens shift systems.

## Adjusting the vertical image position

The vertical image height can be adjusted between 100% and -10% for XGA, 105% and -15% for WXGA of image height. Note that the maximum vertical image height adjustment can be limited by the horizontal image position. For example it is not possible to achieve the maximum vertical image position height detailed above if the horizontal image position is at maximum. Please consult the PureShift Range diagram below for further clarification.

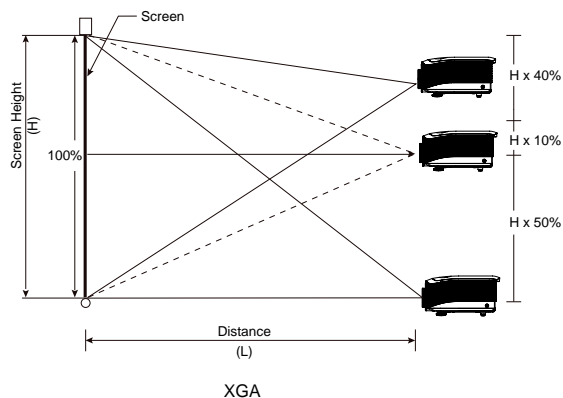
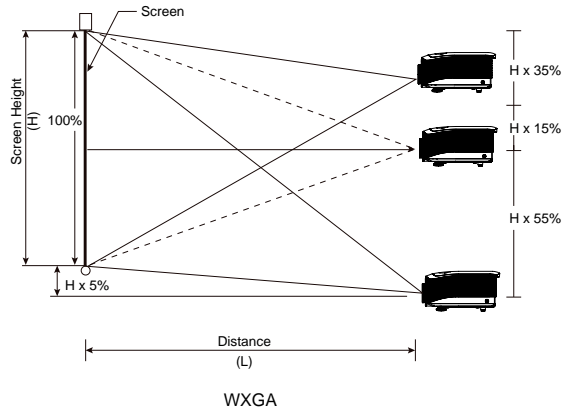

## Adjusting the horizontal image position

With the lens in the center position the horizontal image position can be adjusted to the left or right by up to a maximum of 5% of the image width. Note that the maximum horizontal image height adjustment can be limited by the vertical image position. For example it is not possible to achieve the maximum horizontal image position if the vertical image position is at maximum. Please consult the PureShift Range diagram below for further clarification.

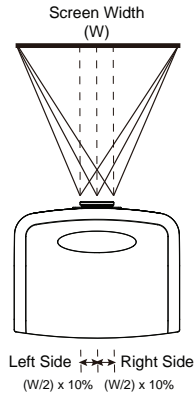

## PureShift Range Diagram

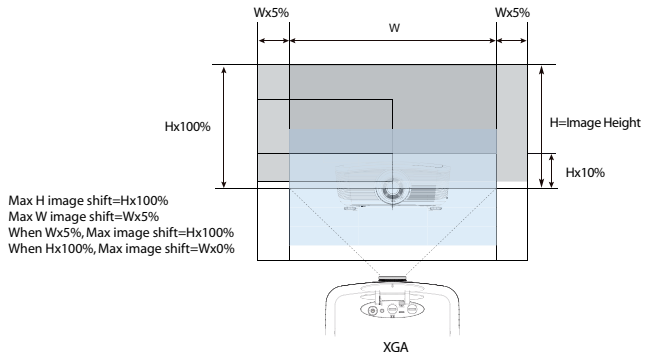
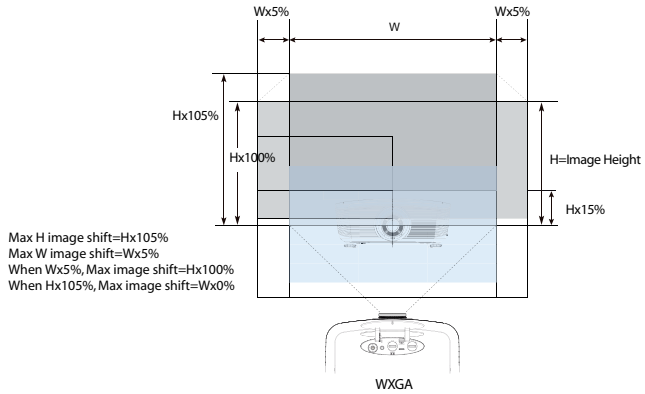

## Adjusting the Zoom / Focus

You may turn the zoom ring to zoom in or out. To focus the image, rotate the focus ring until the image is clear. The projector will focus at distances. See pages 24-25.

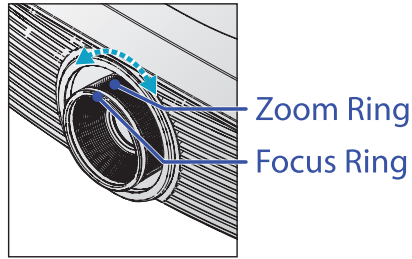

Use the keystone buttons to correct image distortion. They can be found on the remote control and on the projector's control panel.

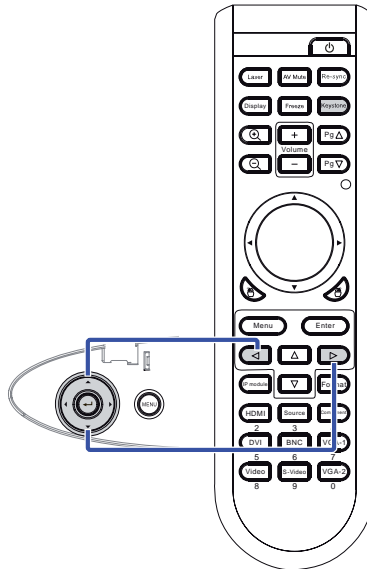

## Adjusting Projection Image Size (XGA)

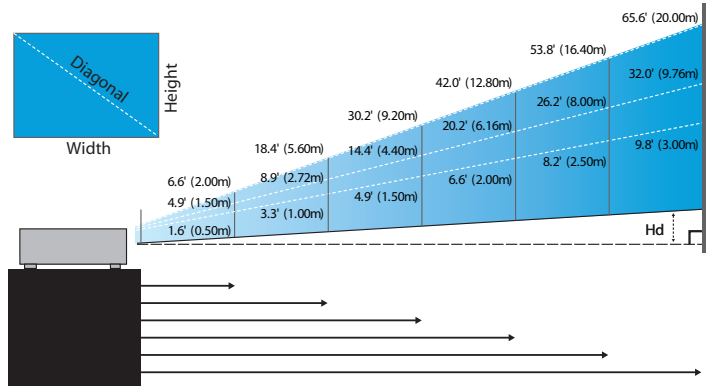

### STD lens: offset=100%

Screen (Diagonal)	Max.	46.1" (117.2cm)	83.7" (212.5cm)	135.3" (343.8cm)	189.5" (481.3cm)	246.1" (625.0cm)	300.2" (762.5cm)
	Min.	36.9" (93.8cm)	66.9" (170.0cm)	108.3" (275.0cm)	151.6" (385.0cm)	196.9" (500.0cm)	240.2" (610.0cm)
Screen size	Max (WxH)	36.9"x27.7" 93.8x70.3cm	66.9"x50.2" 170.0x127.5cm	108.3"x81.2" 275.0x206.3cm	151.6"x113.7" 385.0x288.8cm	196.9"x147.6" 500.0x375.0cm	240.2"x180.1" 610.0x457.5cm
	Min. (WxH)	29.5"x22.1" 75.0x56.3cm	53.5"x40.2" 136.0x102.0cm	86.6"x65.0" 220.0x165.0cm	121.3"x90.9" 308.0x231.0cm	157.5"x118.1" 400.0x300.0cm	192.1"x144.1" 488.0x366.0cm
Distance		4.9' (1.50m)	8.9' (2.72m)	14.4' (4.40m)	20.2' (6.16m)	26.2' (8.00m)	32.0' (9.76m)

### Long lens: offset=100%

Screen (Diagonal)	Max.	49.2" (125.0cm)	137.8" (350.0cm)	226.4" (575.0cm)	315.0" (800.0cm)	403.5" (1025.0cm)	492.1" (1250.0cm)
	Min.	32.8" (83.3cm)	91.9" (233.3cm)	150.9" (383.3cm)	210.0" (533.3cm)	269.0" (683.3cm)	328.1" (833.3cm)
Screen size	Max (WxH)	39.4"x29.5" 100.0x75.0cm	110.2"x82.7" 280.0x210.0cm	181.1"x135.8" 460.0x345.0cm	252.0"x189.0" 640.0x480.0cm	322.8"x242.1" 820.0x615.0cm	393.7"x295.3" 1000.0x750.0cm
	Min. (WxH)	26.2"x19.7" 66.7x50.0cm	73.5"x55.1" 186.7x140.0cm	120.7"x90.6" 306.7x230.0cm	168.0"x126.0" 426.7x320.0cm	215.2"x161.4" 546.7x410.0cm	262.5"x196.9" 666.7x500.0cm
Distance		6.6' (2.00m)	18.4' (5.60m)	30.2' (9.20m)	42.0' (12.80m)	53.8' (16.40m)	65.6' (20.00m)

### Short lens: offset=100%

Screen (Diagonal)	30.8" (78.1cm)	61.5" (156.3cm)	92.3" (234.4cm)	123.0" (312.5cm)	153.8" (390.6cm)	184.5" (468.8cm)
Screen size	24.6"x18.5" 62.5x46.9cm	49.2"x36.9" 125.0x93.8cm	73.8"x55.4" 187.5x140.6cm	98.4"x73.8" 250.0x187.5cm	123.0"x92.3" 312.5x234.4cm	147.6"x110.7" 373.0x281.3cm
Distance	1.6' (0.50m)	3.3' (1.00m)	4.9' (1.50m)	6.6' (2.00m)	8.2' (2.50m)	9.8' (3.00m)



# Installation

## Adjusting Projection Image Size (WXGA)

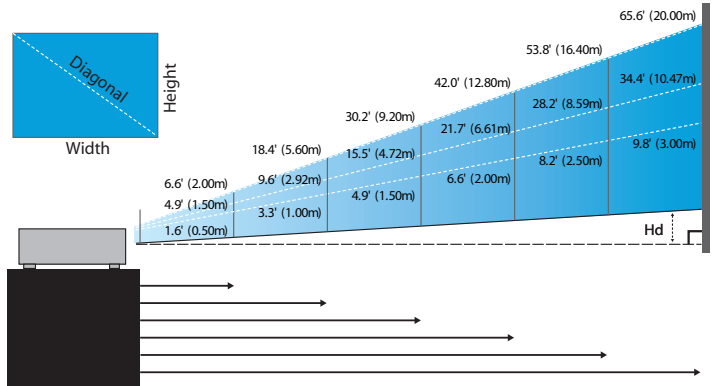

### STD lens: offset=110%

Screen (Diagonal)	Max.	43.0" (109.2cm)	83.7" (212.6cm)	135.3" (343.6cm)	189.4" (481.2cm)	246.2" (623.3cm)	300.1" (762.1cm)
	Min.	34.3" (87.1cm)	66.8" (169.6cm)	107.9" (274.2cm)	151.2" (384.0cm)	196.5" (499.0cm)	239.5" (608.2cm)
Screen size	Max (WxH)	36.5" x 22.8" (92.6x57.9cm)	71.0" x 44.4" (180.2x112.7cm)	114.7" x 71.7" (291.4x182.1cm)	160.6" x 100.4" (408.0x255.0cm)	208.8" x 130.5" (530.2x331.4cm)	254.4" x 159.0" (646.3x403.9cm)
	Min. (WxH)	29.1" x 18.2" (73.9x46.2cm)	56.6" x 35.4" (143.8x89.9cm)	91.5" x 57.2" (232.5x145.3cm)	128.2" x 80.1" (325.6x203.5cm)	166.6" x 104.1" (423.2x264.5cm)	203.1" x 126.9" (515.8x322.4cm)
Hd	Max.	1.1" (2.9cm)	2.2" (5.6cm)	3.6" (9.1cm)	5.0" (12.8cm)	6.5" (16.6cm)	8.0" (20.2cm)
	Min.	0.9" (2.3cm)	1.8" (4.5cm)	2.9" (7.3cm)	4.0" (10.2cm)	5.2" (13.2cm)	6.3" (16.1cm)
Distance		4.9' (1.50m)	9.6' (2.92m)	15.5' (4.72m)	21.7' (6.61m)	28.2' (8.59m)	34.4' (10.47m)

### Long lens: offset=110%

Screen (Diagonal)	Max.	45.7" (116.2cm)	128.1" (325.3cm)	210.4" (534.4cm)	292.7" (743.6cm)	375.1" (952.7cm)	457.4" (1161.8cm)
	Min.	30.4" (77.3cm)	85.2" (216.5cm)	140.0" (355.7cm)	194.8" (494.9cm)	249.6" (634.1cm)	304.4" (773.3cm)
Screen size	Max (WxH)	38.8" x 24.2" (98.5x61.6cm)	108.6" x 67.9" (275.9x172.4cm)	178.4" x 111.5" (453.2x283.3cm)	248.2" x 155.2" (630.5x394.1cm)	318.1" x 198.8" (807.9x504.9cm)	387.9" x 242.4" (985.2x615.8cm)
	Min. (WxH)	25.8" x 16.1" (65.6x41.0cm)	72.3" x 45.2" (183.6x114.8cm)	118.8" x 74.2" (301.6x188.5cm)	165.2" x 103.3" (419.7x262.3cm)	211.7" x 132.3" (537.7x336.1cm)	258.2" x 161.4" (657.4x409.8cm)
Hd	Max.	1.2" (3.1cm)	3.4" (8.6cm)	5.6" (14.2cm)	7.8" (19.7cm)	9.9" (25.2cm)	12.1" (30.8cm)
	Min.	0.8" (2.0cm)	2.3" (5.7cm)	3.7" (9.4cm)	5.2" (13.1cm)	6.6" (16.8cm)	8.1" (20.5cm)
Distance		6.6' (2.00m)	18.4' (5.60m)	30.2' (9.20m)	42.0' (12.80m)	53.8' (16.40m)	65.6' (20.00m)

### Short lens: offset=110%

Screen (Diagonal)	28.7" (72.8cm)	57.3" (145.6cm)	86.0" (218.4cm)	114.6" (291.2cm)	143.3" (364.0cm)	172.0" (436.8cm)
Screen size	24.3" x 15.2" (61.7x38.6cm)	48.6" x 30.4" (123.5x77.2cm)	72.9" x 45.6" (185.2x115.7cm)	97.2" x 60.8" (246.9x154.3cm)	121.5" x 75.9" (308.6x192.9cm)	145.8" x 91.1" (370.4x231.5cm)
Hd	0.8" (1.9cm)	1.5" (3.9cm)	2.3" (5.8cm)	3.0" (7.7cm)	3.8" (9.6cm)	4.6" (11.6cm)
Distance	1.6' (0.50m)	3.3' (1.00m)	4.9' (1.50m)	6.6' (2.00m)	8.2' (2.50m)	9.8' (3.00m)

## Control Panel

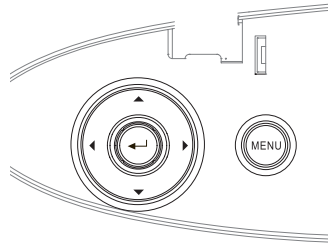







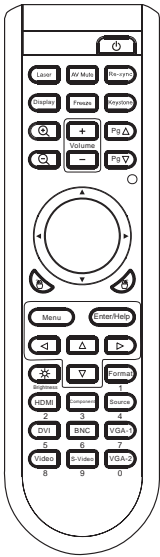

### Using the Control Panel

▲/Keystone+ (Up arrow)	<ul style="list-style-type: none"><li>• Adjust the image Keystone positively.</li><li>• Navigates and changes settings in the OSD.</li></ul>
◀/Source (Left arrow)	<ul style="list-style-type: none"><li>• Press <b>Source</b> to select an input signal.</li><li>• Navigates and changes settings in the OSD.</li></ul>
Enter / Help	Confirm your item selection./ Press to activate Help function (disabled in OSD menus). See page 58 Appendices for help function.
▶/Re-Sync (Right arrow)	<ul style="list-style-type: none"><li>• Automatically synchronizes the projector to the input source.</li><li>• Navigates and changes settings in the OSD.</li></ul>
Menu	Press <b>Menu</b> to launch the on-screen display (OSD) menu. To exit OSD, Press <b>Menu</b> again.

## Remote Control



### Using the Remote Control

Power		Refer to the "Power On/Off the Projector" section on page 17.
Laser		Aim the remote at the viewing screen, press and hold this button to activate the laser pointer.
AV Mute		Momentarily turns off/on the audio and video.
Re-Sync		Automatically synchronizes the projector to the input source.
Display		Press <b>Display</b> to select a Display mode.
Freeze		Press <b>Freeze</b> to pause the screen image.
Keystone		Adjusts image distortion caused by tilting the projector. ( $\pm 30$ degrees)
Zoom+		Press  to zoom in of an image.
Volume +/-		Adjusts to increase/decrease the volume.
Page +		Use this button to page up.
Zoom-		Press  to zoom out of an image.
Page -		Use this button to page down.
PC / Mouse control		The PC/Mouse control can be used to control mouse movement. The mouse function is enabled using the USB cable to connect your computer and the projector.
L Button		Mouse left click.
R Button		Mouse right click.
Menu		Press <b>Menu</b> to launch the on-screen display (OSD) menu. To exit OSD, Press <b>Menu</b> again.



❖ Due to the difference in applications for each country, some regions may have different accessories.

# User Controls

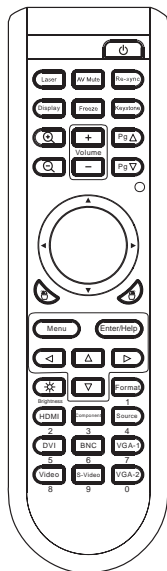

- ❖ Due to the difference in applications for each country, some regions may have different accessories.

## Using the Remote Control

Four Directional Select Keys	Use <b>▲▼◀▶</b> to select items or make adjustments to your selection.
Brightness	 Adjust the brightness of the image.
Format	Press <b>Format</b> to select the image ratio.
HDMI	Press <b>HDMI</b> to choose HDMI source.
Component Source	Press <b>Component</b> to choose Component source.
DVI	Press <b>DVI</b> to choose source from DVI-D connector.
BNC	Press <b>BNC</b> to choose BNC source.
VGA-1	Press <b>VGA-1</b> to choose source from VGA- IN connector.
Video	Press <b>Video</b> to choose Composite video source.
S-Video	Press <b>S-Video</b> to choose S-Video source.
VGA-2	Press <b>VGA-2</b> to choose source from VGA- IN connector.

## On-screen Display Menus

The Projector has multilingual On-screen Display menus that allow you to make image adjustments and change a variety of settings. The projector will automatically detect the source.

### How to operate

1. To open the OSD menu, press **Menu** on the Remote Control or Projector Keypad.
2. When OSD is displayed, use ◀▶ keys to select any item in the main menu. While making a selection on a particular page, press ▼ or **Enter** to enter sub menu.
3. Use ▲▼ keys to select the desired item and adjust the settings by ▶ key.
4. Select the next item to be adjusted in the sub menu and adjust as described above.
5. Press **Enter** to confirm, and the screen will return to the main menu.
6. To exit, press **Menu** again. The OSD menu back to last level projector will automatically save the new settings.

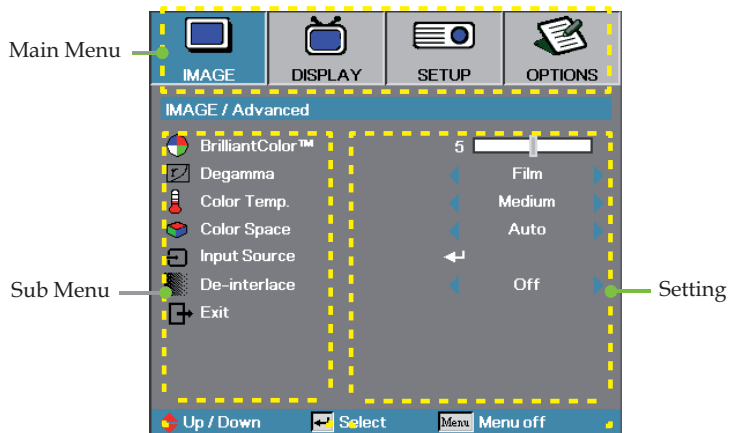

## Menu Tree

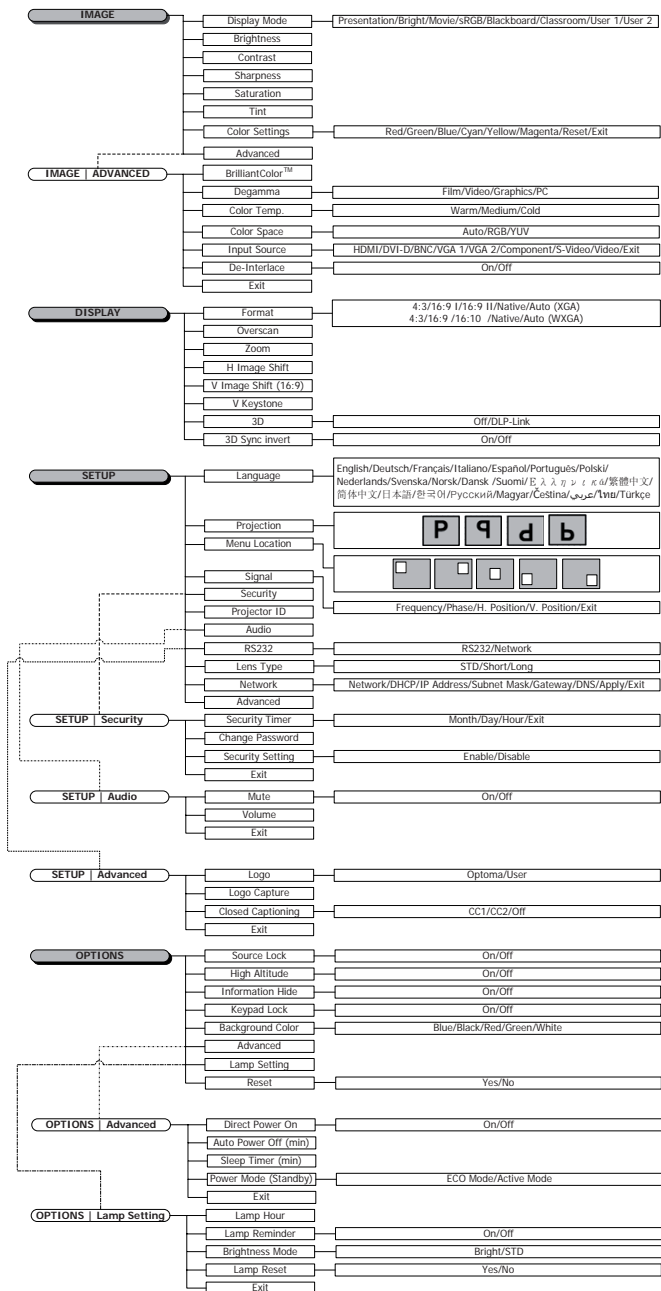

## Image

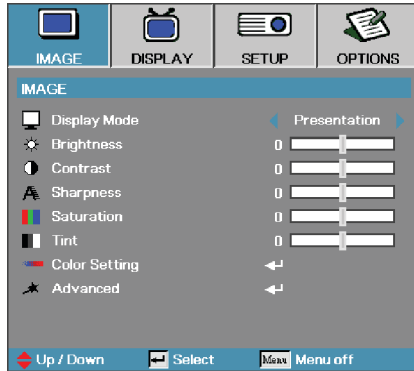

### Display Mode

There are many factory presets optimized for various types of images.

- ▶ Presentation: Good color and brightness from PC input.
- ▶ Bright: Maximum brightness from PC input.
- ▶ Movie: For home theater.
- ▶ sRGB: Standardised accurate color.
- ▶ Blackboard: Tuned for blackboard usage.
- ▶ Classroom: Recommended settings for classroom.
- ▶ User1: User's own settings.
- ▶ User2: User's own settings.

The initial default settings of this mode is from Movie mode.

Any further adjustments by the user in User1/2 will be saved in this mode for future use.

### Brightness

Adjust the brightness of the image.

- ▶ Press ◀ to darken image.
- ▶ Press ▶ to lighten the image.

### Contrast

The contrast controls the degree of difference between the lightest and darkest parts of the picture.

- ▶ Press ◀ to decrease the contrast.
- ▶ Press ▶ to increase the contrast.

### Sharpness

Adjusts the sharpness of the image.

- ▶ Press ◀ to decrease the sharpness.
- ▶ Press ▶ to increase the sharpness.

## Image

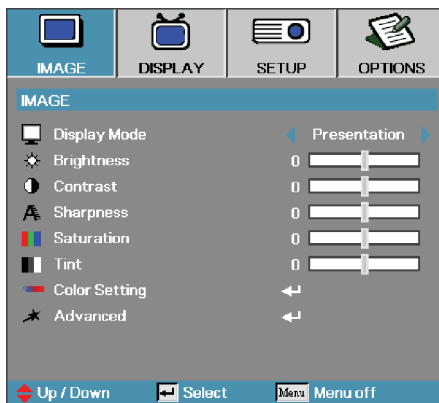

### Saturation

Adjusts a video image from black and white to full color saturation.

- ▶ Press ◀ to decrease the amount of saturation in the image.
- ▶ Press ▶ to increase the amount of saturation in the image.

### Tint

Adjusts the color balance of red and green.

- ▶ Press ◀ to increase the amount of green in the image.
- ▶ Press ▶ to increase the amount of red in the image.

### Color Setting

Enter the Color Setting menu. Select the Red/Green/Blue Gain for brightness adjustments and Bias for contrast adjustments for the whole picture. Individual color adjustments for Cyan, Magenta, Yellow can also be adjusted. See page 33 for more details.

### Advanced

Enter the Advanced menu. Select advanced display options such as BrilliantColor™, Degamma, Color Temp., Color Space, Input Source, De-Interlace, and Exit. See page 35 for more information.



## Image | Color Setting



### Red

Increase or decrease the color value for red.

### Green

Increase or decrease the color value for green.

### Blue

Increase or decrease the color value for blue.

### Cyan

Increase or decrease the color value for cyan.

### Yellow

Increase or decrease the color value for yellow.

### Magenta

Increase or decrease the color value for magenta.

### Reset

Reset all Color Setting values to the factory default.

## Image | Color Setting / HSG

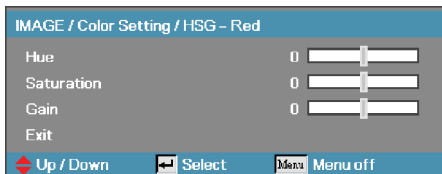

### Hue

Adjust the color balance of red and green.

- ▶ Press ◀ to increase the amount of green in the image.
- ▶ Press ▶ to increase the amount of red in the image.

### Saturation

Adjusts a video image from black and white to full color saturation.

- ▶ Press ◀ to decrease the amount of saturation in the image.
- ▶ Press ▶ to increase the amount of saturation in the image.

### Gain

Set Red Gain to adjust the Brightness:

- ▶ Increase or decrease the gain value for red.



- ❖ Green, Blue, Cyan, Yellow, Magenta can be separate adjust by each color HSG.

## Image | Advanced

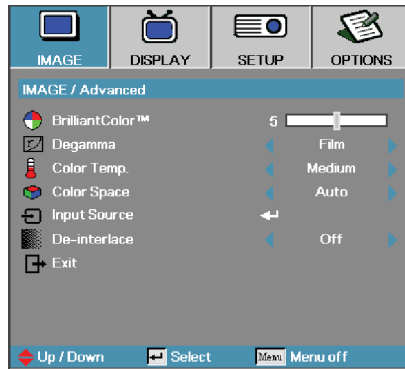

### BrilliantColor™

This adjustable item utilizes a new color-processing algorithm and system level enhancements to enable higher brightness while providing true, more vibrant colors in picture. The range is from 0 to 10. If you prefer a stronger enhanced image, adjust toward the maximum setting. For a smoother, more natural image, adjust toward the minimum setting.

### Degamma

This allows you to choose a degamma table that has been fine-tuned to bring out the best image quality for the input.

- ▶ Film—for home theater.
- ▶ Video—for video or TV source.
- ▶ Graphics—for image source.
- ▶ PC—for PC or computer source.

### Color Temp

Adjust the color temperature. Cold temperature, the screen looks colder; with Warm temperature, the screen looks warmer.

### Color Space

Select an appropriate color matrix type from AUTO, RGB, YUV.

### Input Source

Enter the Input Source submenu. Select the sources to scan for at startup. See page 36 for more information.

### De-interlace

Press the cursor ◀ or ▶ button to select different De-interlace modes. This function converts an interlaced video signal into progressive signal.

- ▶ On: Use this mode for Films.
- ▶ Off: Use this mode for Video or TV sources.



- ❖ De-interlace only support 480i/576i/1080i signal via Component/S-video/Video.

## Image | Advanced | Input Source

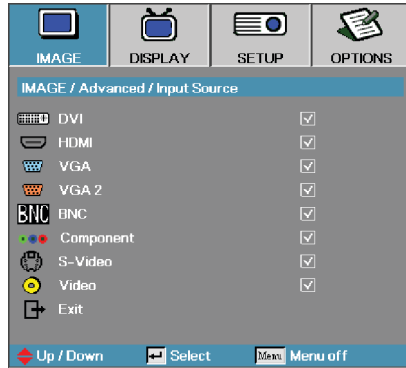

- ❖ If all sources are deselected, the projector cannot display any images. Always leave at least one source selected.

### Input Source

Use this option to enable / disable input sources. Press ▲ or ▼ to select a source, then press ◀ or ▶ to enable / disable it. Press **Enter** to finalize the selection. The projector will not search inputs that are de-selected.

## Display

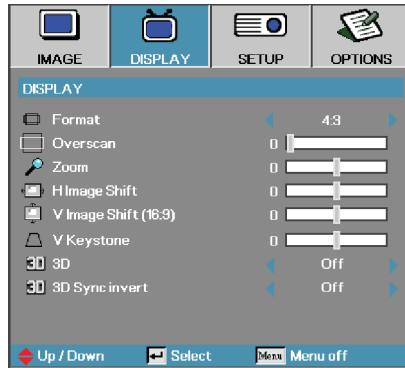

### Format

Use this function to choose your desired aspect ratio.

- ▶ 4:3: This format is for 4x3 input sources not enhanced for Wide screen TV.
- ▶ 16:9 I (XGA) | 16:9 (WXGA): This format is for 16x9 input sources, like HDTV and DVD enhanced for Wide screen TV.
- ▶ 16:9 II (XGA) | 16:10 (WXGA): The non-standard wide-screen display format of the projector. Part of the original image will be cut if the image aspect ratio is less than 1.67:1.
- ▶ Native: Depends on the resolution of the input source - No scaling is performed.
- ▶ Auto: Automatically selects the appropriate format.

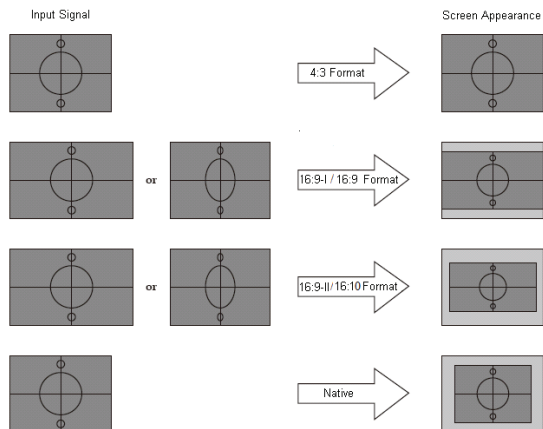

## Display

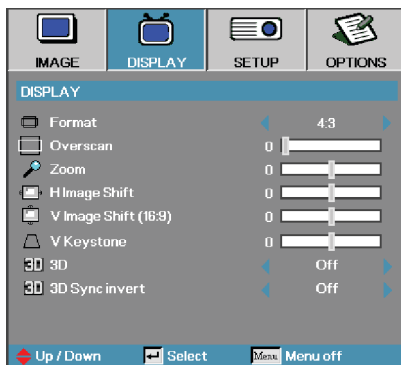

### Overscan

Overscan function removes the noise in a video image. Overscan the image to remove video encoding noise on the edge of video source.

### Zoom

- ▶ Press ◀ to reduce the size of the image.
- ▶ Press ▶ to magnify an image on the projected screen.

### H Image Shift

Shifts the projected image position horizontally.

- ▶ Press ◀ to move the image left on the projected screen.
- ▶ Press ▶ to move the image right on the projected screen.

### V Image Shift (16:9 only)

Shifts the projected image position vertically (in 16:9 format only).

- ▶ Press ▶ to move the image up on the projected screen.
- ▶ Press ◀ to move the image down on the projected screen.

### V Keystone

Press ◀ or ▶ to compensate for vertical images distortion when the projector is positioned at an angle to the screen.

### 3D

Press ◀ or ▶ to enable or disable the **3D** function. When the **3D** function is enabled, the current picture mode adjustment will be disabled.

### 3D Sync invert

Press ◀ or ▶ to enable or disable the **3D Sync invert** function to invert images.

## Setup

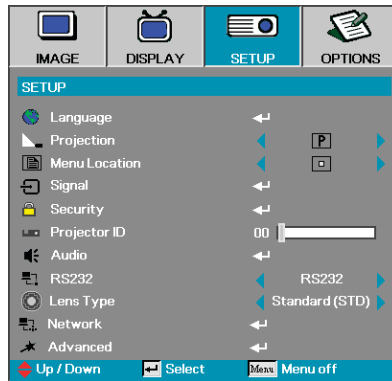

### Language

Enter the Language menu. Select the multilingual OSD menu. See page 41 for more information.

### Projection

Select projection method:

- ▶ **P** Front Desktop  
The factory default setting.
- ▶ **q** Rear Desktop  
When you select this function, the projector reverses the image so you can project from behind a translucent screen.
- ▶ **d** Front Ceiling  
When you select this function, the projector turns the image upside down for ceiling-mounted projection.
- ▶ **b** Rear Ceiling  
When you select this function, the projector reverses and turns the image upside down at same time. You can project from behind a translucent screen with ceiling mounted projection.

### Menu Location

Choose the menu location on the display screen.

## Setup

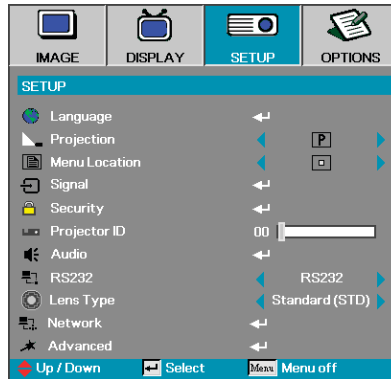

### Signal

Enter the Signal menu. Set projector signal properties. See page 42 for more information.

### Security

Enter the Security menu. Access the projector's security features. See page 43 for more information.

### Projector ID

Select a two digit projector ID from 0 through 99.

### Audio

Enter the Audio menu. Set audio level properties. See page 46 for more information.

### RS232

Allows RS232 control of an individual projector.

### Lens Type

Used to set the lens type that has been fitted. This is to ensure correct operation of the lens iris.

### Network

Allows LAN via web browser (Internet Explorer) to control of projector. See pages 49 for more information.

### Advanced

Enter the Advanced menu. Select the screen display during startup. See page 47 for more information.



## Setup | Language



### Language

Choose the multilingual OSD menu. Press **ENTER** ( **↵** ) into the sub menu and then use the Left ( **◀** ) or Right ( **▶** ) key to select your preferred language.

## Setup | Signal

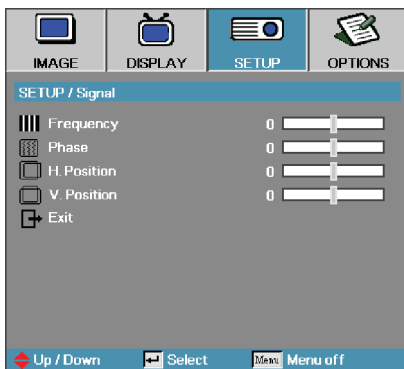

### Frequency

Change the display data frequency to match the frequency of your computer's graphics card. If you experience a vertical flickering bar, use this function to make an adjustment.

### Phase

Phase synchronizes the signal timing of the display with the graphics card. If you experience an unstable or flickering image, use this function to correct it.

### H. Position

- ▶ Press ◀ to move the image left.
- ▶ Press ▶ to move the image right.

### V. Position

- ▶ Press ◀ to move the image down.
- ▶ Press ▶ to move the image up.

## Setup | Security



### Security Timer

Enter the Security Timer sub menu.

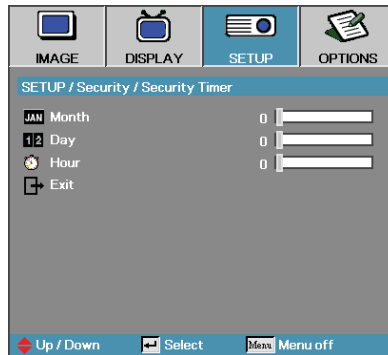

- ❖ No password is required to access Setup | Security unless the Security Timer or Security Setting are enabled.

Enter the Months, Days, and hours that the projector can be used without entering the password. Exiting to the Setup menu activates the Security Timer.

Once activated, the projector requires a password on the specified dates and times to allow power on and access to the security menu.

If the projector is in use and the Security Timer is active, the following screen displays 60 seconds before the password is required.



## Setup | Security

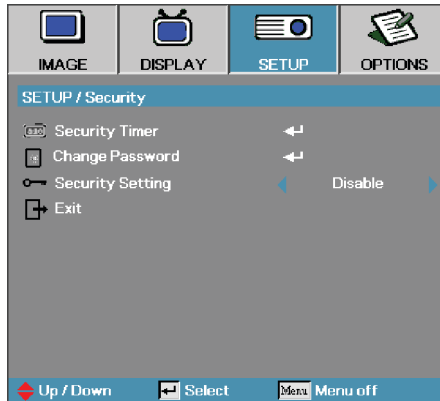

- ❖ If the incorrect password is entered three times, the device auto shutdowns after 10 seconds.

### Change Password

Use this submenu to change the security password for the projector.

1. Select Change Password from the Security submenu. The Confirm Change Password dialog box displays.
2. Select Yes.



3. Enter the default password <1> <2> <3> <4> <5>.  
A second password screen displays.

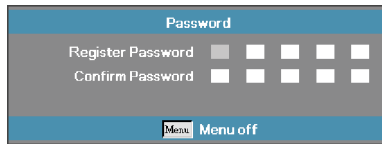

- ❖ If the new passwords do not match, the password screen redisplay.

4. Enter the new password twice for verification.

## Setup | Security



### Security Setting

Enable or disable the security password.

- ▶ Enabled – the current password is required to power on the projector and access the Security menu.
- ▶ Disabled – no password is required for any function.

When security is enabled, the following screen displays at startup and before access to the Security menu is allowed:

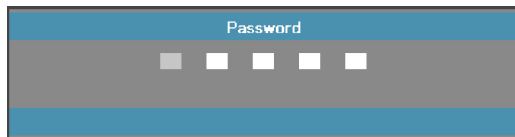

## Setup | Audio



### Volume

- Press ◀ to decrease the volume of voice.
- Press ▶ to increase the volume of voice.

### Mute

- Toggle the audio on or off.
- ▶ Off—the speaker volume is turned on.
- ▶ On—the speaker volume is turned off.

## Setup | Advanced

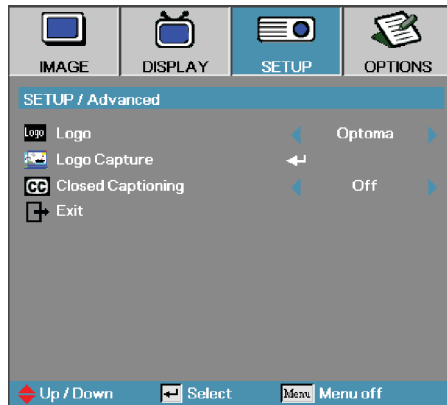

### Logo

Select the screen to display during startup.

- ▶ Optoma—the supplied default startup screen.
- ▶ User—customized screen capture using the Logo Capture function.

### Logo Capture

Capture a displayed screen to use as the startup screen.

1. Display the desired screen on the projector.
2. Select Logo Capture from the Advanced menu.

A confirmation screen displays.



- ❖ Only one startup screen can be saved at once. Subsequent captures overwrite previous files limited in 1.5MB.

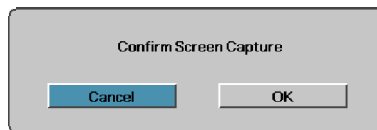

3. Select OK. Screen capture in progress will display. When finished, Screen capture Succeeded will display. The captured screen is saved as User in the logo menu.

### Closed Captioning

Select the screen to display closed captioning

- ▶ Off—the supplied default setting.
- ▶ CC1 I CC2—closed captioning type select.

## Setup | RS232



### RS232

Press **Enter** to enter the RS232 sub menu and use the Left (◀) or Right (▶) key to select your preferred RS232 control.

When selecting **Network**, a message displays as below:

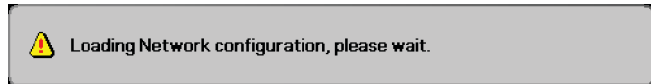



## Setup | Network

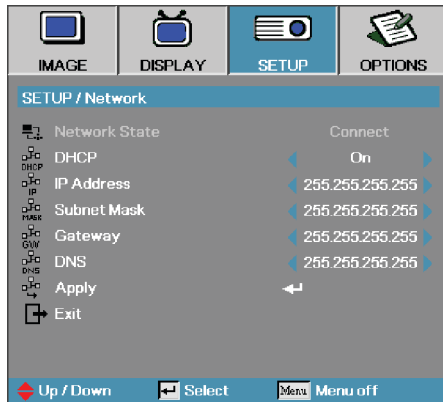

### Network

Press **Enter** to apply Network settings. If the connection is successful, the OSD display will show the following dialogue box.

- ▶ Network State – to display network information.
- ▶ DHCP:
  - On: Assign an IP address to the projector from the DHCP server automatically.
  - Off: Assign an IP address manually.
- ▶ IP Address – Select an IP address
- ▶ Subnet Mask – Select subnet mask number.
- ▶ Gateway – Select the default gateway of the network connected to the projector.
- ▶ DNS – Select DNS number.
- ▶ Apply – Press **Enter** to apply the selection.

## Options

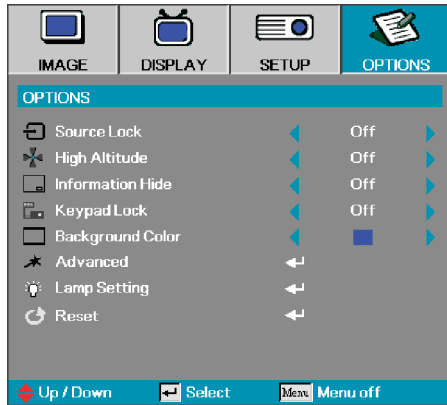

### Source Lock

Lock the current source as the only available source, even if the cable is unplugged.

- ▶ On—only the current source is recognized as an input source.
- ▶ Off—all sources selected in Image | Advanced | Input Source are recognized as an input source.

### High Altitude

Adjust the fan speed to reflect the environment.

- ▶ On—increases fan speed for high temperature, humidity, or altitude.
- ▶ Off—regular fan speed for normal conditions.

### Information Hide

Suppress informational messages on the projected screen.

- ▶ On—no status messages appear on screen during operation.
- ▶ Off—status messages appear as normal on screen during operation.

### Keypad Lock

Lock the buttons on the projector top panel.

- ▶ On—a warning message displays to confirm keypad lock.



- ▶ Off—projector keypad functions as normal.

## Options

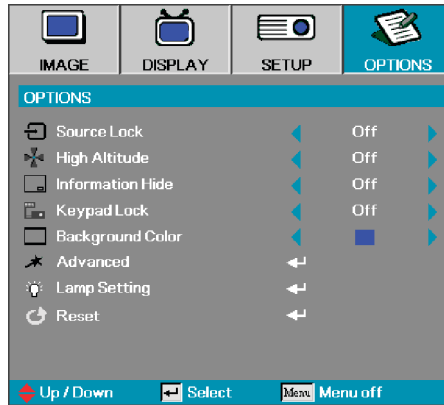

### Background Color

Select the desired background color for the projected image when no source is detected.

### Advanced

Enter the Advanced menu. See page 52 for more details.

### Lamp Setting

Enter the Lamp Setting menu. See pages 53-54 for more details.

### Reset

Reset all Options to default factory settings.

## Options | Advanced

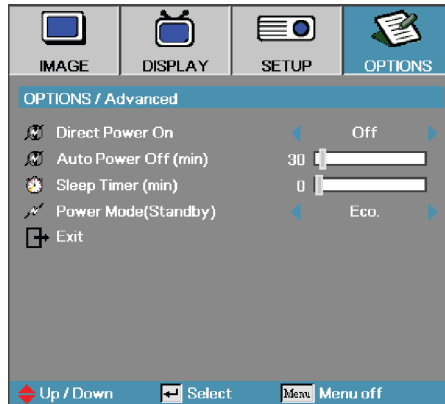

### Direct Power On

Enable or disable Direct Power On.

- ▶ On—the projector powers on automatically when AC power is supplied.
- ▶ Off—the projector must be powered on as normal.

### Auto Power Off

Set the Auto Power Off interval. The projector powers off the lamp after 30 minutes of no signal by default. The following warning is displayed 60 seconds before power off.

The projector will automatically shutdown after 60 sec.

### Sleep Timer

Set the Sleep Timer interval. The projector powers off after the specified time period of inactivity (regardless of signal). The following warning is displayed 60 seconds before power off.

The projector will automatically shutdown after 60 sec.

### Power Mode

Set the projector in ECO Mode or Active Mode.

## Options | Lamp Setting

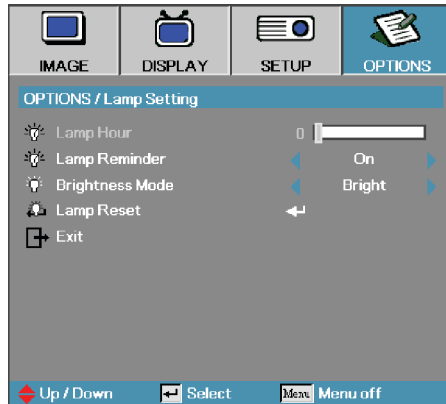

### Lamp Hour

Displays the number of hours the lamp has been active. This item is for display only.

### Lamp Reminder

Enable or disable the lamp life span reminder.

- ▶ On—a warning message displays when remaining lamp life is less than 30 hours.

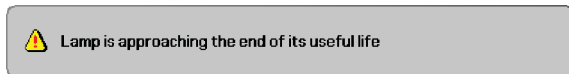

- ▶ Off—no warning message displays.

### Brightness Mode

Select the lamp brightness mode.

- ▶ Bright—the default setting.
- ▶ STD—lower brightness setting to conserve lamp life.

## Options | Lamp Setting

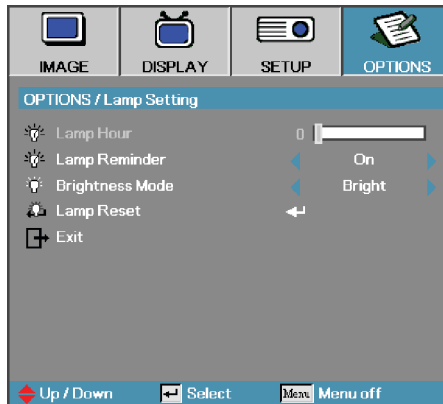

### Lamp Reset

After replacing the lamp, reset the lamp counter to accurately reflect the new lamp's life span.

1. Select Lamp Reset.

A confirmation screen displays.



2. Select **Yes** to reset the lamp counter to zero.

## LAN\_RJ45



- ❖ Projector connects to LAN, please use Ethernet Normal Cable.
- ❖ Peer-to-peer (PC connects to Projector directly), please use Ethernet Crossover Cable.

For simplicity and ease of operation, the Optoma projector provides diverse networking and remote management features. The LAN/RJ45 function of the projector through a network, such as remotely manage: Power On/Off, Brightness and Contrast settings. Also, projector status information, such as: Video-Source, Sound-Mute, etc.

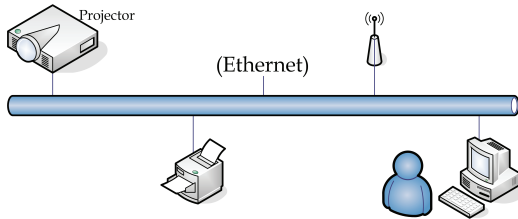

## LAN RJ45

1. Connect an RJ45 cable to RJ45 ports on the projector and the PC (Laptop).

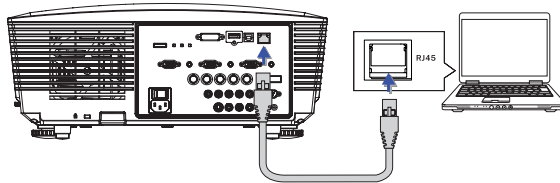

2. On the PC (Laptop), select Start -> Control Panel-> Network Connections.

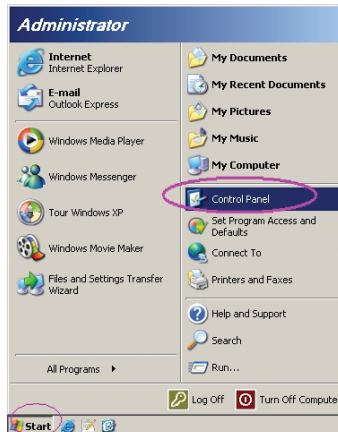

# User Controls

3. Right Click on your Local Area Connection, and select Property.

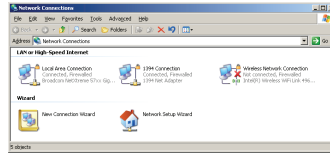

4. In the Properties window, select the **General** tab, and select **Internet Protocol (TCP/IP)**.

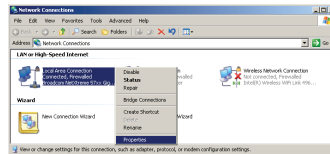

5. Click **Properties**.

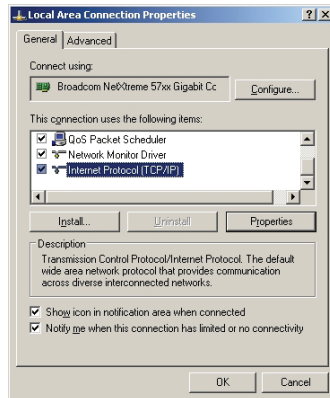

6. Fill in the IP address and Subnet mask, then press OK.

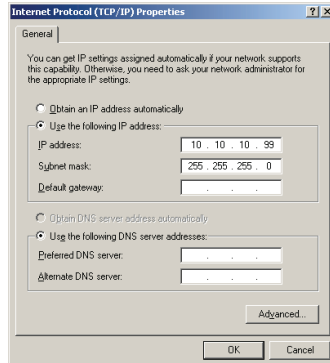



# User Controls

7. Press the **Menu** button on the projector.
8. Select OSD-> SETUP-> Network-> Enabled.
9. Input the following:
  - ▶ IP Address: 10.10.10.10
  - ▶ Subnet Mask: 255.255.255.0
  - ▶ Gateway: 0.0.0.0
  - ▶ DNS: 0.0.0.0
10. Press **Apply** (Enter) to confirm settings.
11. Open a web browser (ex, Microsoft Internet Explorer with Adobe Flash Player 9.0 or higher).

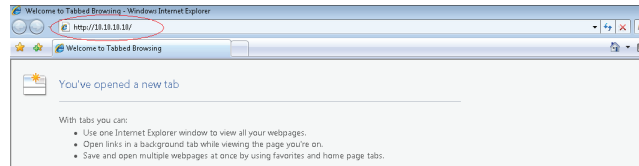

12. In the Address bar, input the IP address: 10.10.10.10.

13. Press **Apply**.

The projector is setup for remote management. The LAN/RJ45 function displays as follows.



❖ For more information, please visit <http://www.crestron.com>

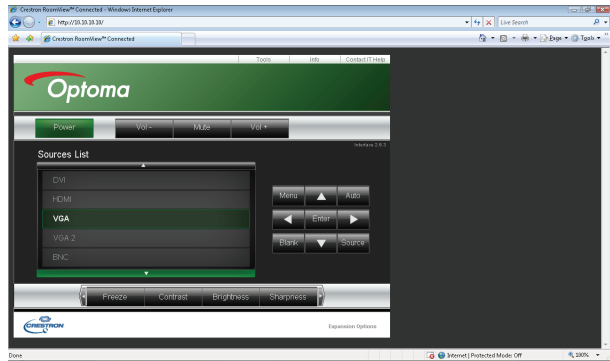

## Troubleshooting/ Help On-screen Display Menu

If you experience a problem with your projector, please refer to the following information. If a problem persists, please contact your local reseller or service center.

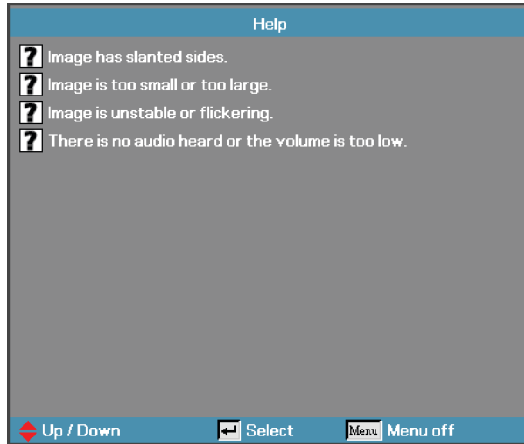

## Image Problems

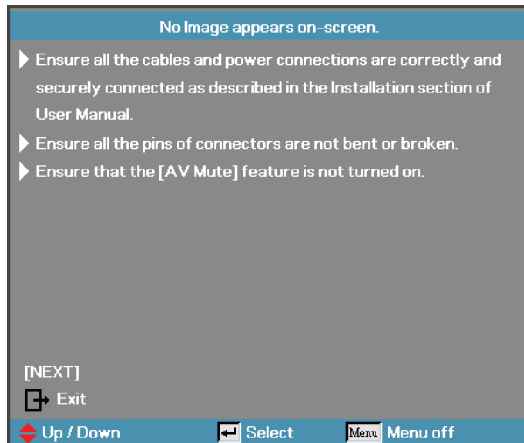

## No image appears on-screen

- ▶ Ensure all the cables and power connections are correctly and securely connected as described in the **Installation** section.
- ▶ Ensure all the pins of connectors are not bent or broken.

- ▶ Check if the projection lamp has been securely installed. Please refer to the **Replacing the lamp** section.
- ▶ Make sure you have removed the lens cap and the projector is switched on.

## Partial, scrolling or incorrectly displayed image

- ▶ Press “Re-Sync” on the remote.
- ▶ If you are using a PC:  
For Windows 95, 98, 2000, XP:
  1. Open the **My Computer** icon, the **Control Panel** folder, and then double click on the **Display** icon.
  2. Select the **Settings** tab.
  3. Verify that your display resolution setting is lower than or equal to UXGA (1600 x 1200).
  4. Click on the **Advanced Properties** button.  
If the projector is still not projecting the whole image, you will also need to change the monitor display you are using. Refer to the following steps.
  5. Verify the resolution setting is lower than or equal to UXGA (1600 x 1200).
  6. Select the **Change** button under the **Monitor** tab.
  7. Click on **Show all devices**. Next, select **Standard monitor types** under the SP box; choose the resolution mode you need under the “Models” box.
  8. Verify that the resolution setting of the monitor display is lower than or equal to UXGA (1600 x 1200). (\*)

- ▶ If you are using a Notebook:

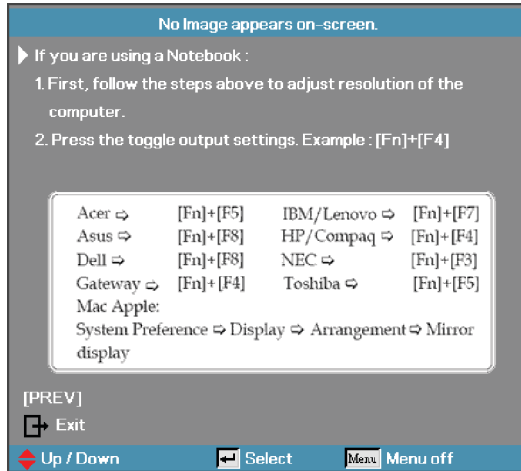

1. First, follow the steps above to adjust resolution of the computer.
2. Press the toggle output settings. Example: [Fn]+[F4]

Acer ⇨	[Fn]+[F5]	IBM/Lenovo ⇨	[Fn]+[F7]
Asus ⇨	[Fn]+[F8]	HP/Compaq ⇨	[Fn]+[F4]
Dell ⇨	[Fn]+[F8]	NEC ⇨	[Fn]+[F3]
Gateway ⇨	[Fn]+[F4]	Toshiba ⇨	[Fn]+[F5]

---

Mac Apple:  
System Preference ⇨ Display ⇨ Arrangement ⇨ Mirror display

If you experience difficulty changing resolutions or your monitor freezes, restart all equipment including the projector.

## The screen of the Notebook or PowerBook computer is not displaying your presentation

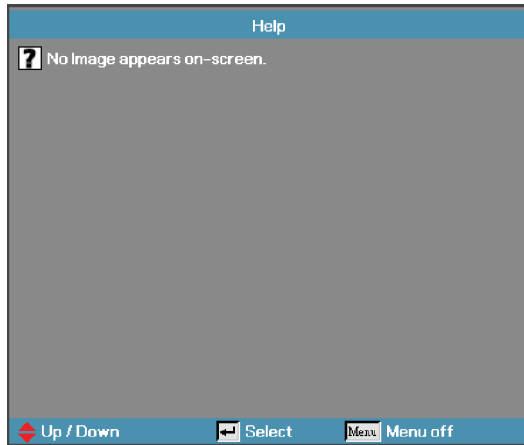

- ▶ If you are using a Notebook:  
Some Notebooks may deactivate their own screens when a second display device is in use. Each has a different way to be reactivated. Refer to your computer's manual for detailed information.

## Image is unstable or flickering

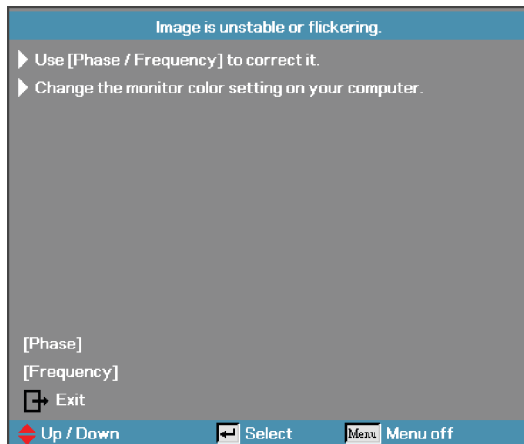

- ▶ Use **Phase** to correct it. See page 42 for more information.
- ▶ Change the monitor color setting on your computer.

## Image has vertical flickering bar

- ▶ Use **Frequency** to make an adjustment. See page 42 for more information.
- ▶ Check and reconfigure the display mode of your graphic card to make it compatible with the projector.

## Image is out of focus

- ▶ Make sure the lens cap is removed.
- ▶ Adjusts the Focus Ring on the projector lens.
- ▶ Make sure the projection screen is between the required distances from the projector. See pages 24-25 for more information.

## The image is stretched when displaying 16:9 DVD title

When you play anamorphic DVD or 16:9 DVD, the projector will show the best image in 16:9 format in OSD. If you play 4:3 format DVD title, please change the format as 4:3 in projector OSD. If the image is still stretched, you will also need to adjust the aspect ratio by referring to the following:

- ▶ Please setup the display format as 16:9 (wide) aspect ratio type on your DVD player.

## Image is too small or too large

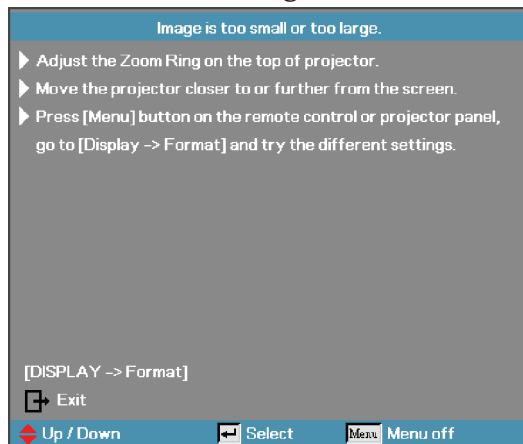

- ▶ Adjust the Zoom Ring on the top of the projector.
- ▶ Move the projector closer to or further from the screen.
- ▶ Press [Menu] button on the remote control or projector panel, go to **Display | Format** and try the different settings.

## Image has slanted sides

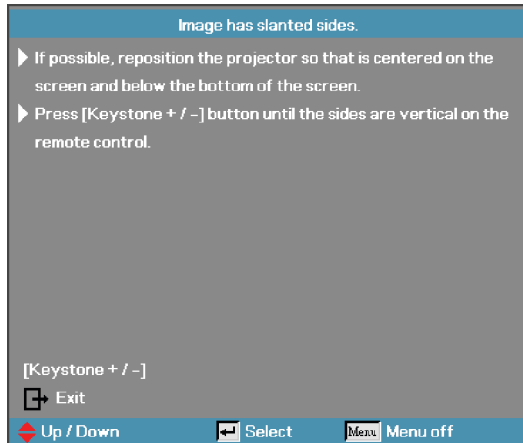

- ▶ If possible, reposition the projector so that it is centered on the screen and below the bottom of the screen.
- ▶ Press [Keystone +/-] on the remote control until the sides are vertical.

## Image is reversed

- ▶ Select **Setup | Projection** from the OSD and adjust the projection direction.

## Intermission Problems

### The projector stops responding to all controls

- ▶ If possible, turn off the projector, then unplug the power cord and wait at least 60 seconds before reconnecting power.

### Lamp burns out or makes a popping sound

- ▶ When the lamp reaches its end of life, it will burn out and may make a loud popping sound. If this happens, the projector will not turn on until the lamp module has been replaced. To replace the lamp, follow the procedures in Replacing the Lamp on page 60.

## HDMI Q & A

### What is the difference between a “Standard” HDMI cable and a “High-Speed” HDMI cable?

Recently, HDMI Licensing, LLC announced that cables would be tested as Standard or High-Speed cables.

- ▶ Standard (or “category 1”) HDMI cables have been tested to perform at speeds of 75Mhz or up to 2.25Gbps, which is the equivalent of a 720p/1080i signal.
- ▶ High Speed (or “category 2”) HDMI cables have been tested to perform at speeds of 340Mhz or up to 10.2Gbps, which is the highest bandwidth currently available over an HDMI cable and can successfully handle 1080p signals including those at increased color depths and/or increased refresh rates from the Source. High-Speed cables are also able to accommodate higher resolution displays, such as WQXGA cinema monitors (resolution of 2560 x 1600).

### How do I run HDMI cables longer than 10 meters?

- ▶ There are many HDMI Adapters working on HDMI solutions that extend a cable’s effective distance from the typical 10 meter range to much longer lengths. These companies manufacture a variety of solutions that include active cables (active electronics built into cables that boost and extend the cable’s signal), repeaters, amplifiers as well as CAT5/6 and fiber solutions.

### How can I tell if a cable is an HDMI certified cable?

- ▶ All HDMI products are required to be certified by the manufacturer as part of the HDMI Compliance Test Specification. However, there may be instances where cables bearing the HDMI logo are available but have not been properly tested. HDMI Licensing, LLC actively investigates these instances to ensure that the HDMI trademark is properly used in the market. We recommend that consumers buy their cables from a reputable source and a company that is trusted.

For more detail information check:

<http://www.hdmi.org/learningcenter/faq.aspx#49>



## Projector Status Indication

Message	Power LED	Power LED	Temp LED	Lamp LED
	(Blue)	(Amber)	(Red)	(Red)
Standby State (Input power cord)	○	☀	○	○
Standby State (Burn in Mode)	Flashing	○	☀	☀
Power on with OSD (Press power button)	* ☀	○	○	○
Power on without OSD	○	○	○	○
Over Temperature	☀	○	☀	○
Fan Fail	☀	○	Flashing	○
Lamp error	☀	○	○	☀
Power off (Cooling)	☀	○	○	○

\* Power LED will be ON when OSD appears and OFF when OSD disappears.



Steady light ⇔ ☀

No light ⇔ ○

The digit represents the number of led blinks.

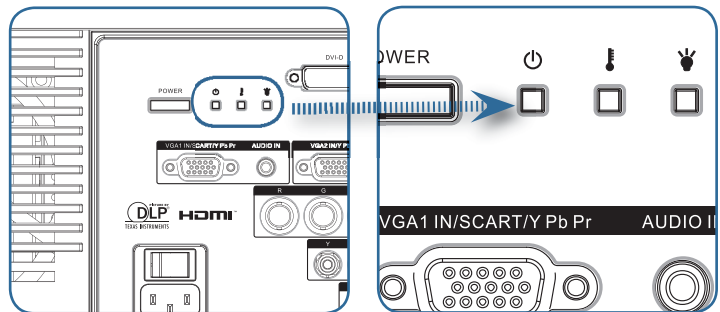

## LED Error Code Messages

Error Code Message	Power LED □ 0	Lamp LED □ ▼
	(Blink)	(Blink)
T1 temperature over temperature	3	0
Thermal Break	4	0
G794 fail	4	4
T1 fail	4	5
Lamp error	5	0
Ballast Over Temperature	5	1
Ballast shot circuit in output detected	5	2
End of lamp lift detected	5	3
Ballast lamp did not ignite	5	4
Lamp extinguished during normal operation	5	5
Lamp extinguished during run-up phase	5	6
Fan1 error (Lamp Fan)	6	1
Fan2 error (Ballast Fan)	6	2
Fan3 error (Burner Fan)	6	3
Fan4 error (Power Fan)	6	4
Lamp door open	7	0
DMD error	8	0
Color wheel error	9	0

## Message Reminders

- ▶ Replacing the lamp:

 Lamp is approaching the end of its useful life

- ▶ Out of range: (see the following for more information)



**Signal out of range  
lower image resolution.**

## Remote Control Problems

If the remote control does not work

- ▶ Check the operating angle for the remote control is approximately  $\pm 15^\circ$ .
- ▶ Make sure there are no obstructions between the remote control and the projector. Move to within 7m (23 ft) of the projector.
- ▶ Make sure the batteries are inserted correctly.
- ▶ Replace weak batteries in the remote control.

## Audio Problems

### There is no sound

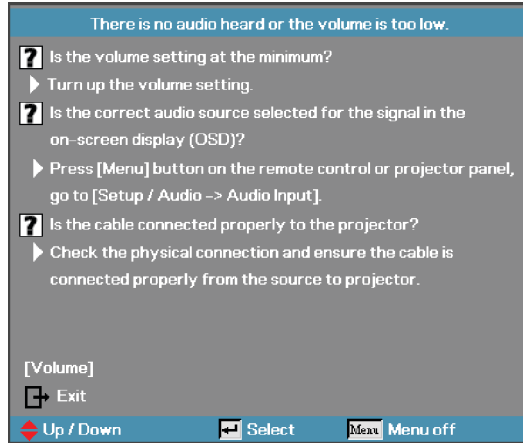

- ▶ Adjust the volume on the remote control.
- ▶ Adjust the volume of the audio source.
- ▶ Check the audio cable connection.
- ▶ Test the source audio output with other speakers.
- ▶ Have the projector serviced.

### The sound is distorted

- ▶ Check the audio cable connection.
- ▶ Test the source audio output with other speakers.
- ▶ Have the projector serviced.

## Replacing the Lamp

The projection lamp should be replaced when it burns out. It should only be replaced with a certified replacement part, which you can order from your local dealer.

Important:

- ▶ The lamp contains a certain amount of mercury and should be disposed of according to local ordinance regulations.
- ▶ Avoid touching the glass surface of the new lamp, doing so may shorten its operation life.



Warning:

- ▶ Be sure to turn off and unplug the projector at least an hour before replacing the lamp. Failure to do so could result in a severe burn.

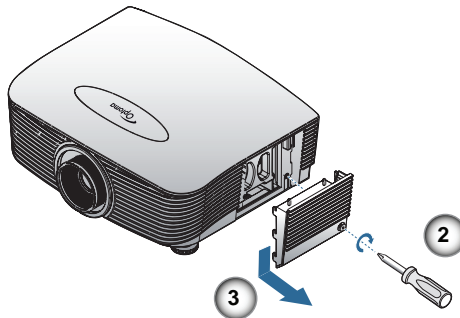
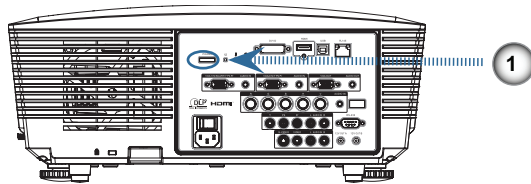

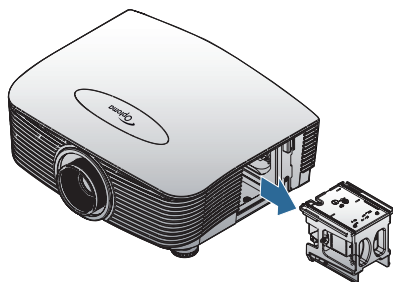
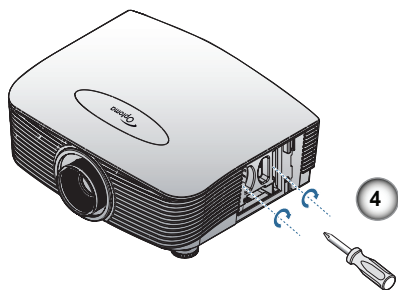

1. Switch off the power to the projector by pressing the Power button.
2. Allow the projector to cool down at least 30 minutes.
3. Disconnect the power cord.
4. Unlock the lamp cover.
5. Pull up and remove the cover.
6. Use a screwdriver to remove the screws from the lamp module.
7. Pull out the lamp module.

To replace the lamp module, reverse the previous steps.

After replacing the lamp, the lamp hours counter must be reset. See page 54 for more information.

## Cleaning the Projector

Cleaning the projector to remove dust and grime will help ensure trouble-free operation.

Warning:

- ▶ Be sure to turn off and unplug the projector at least an hour before cleaning. Failure to do so could result in a severe burn.
- ▶ Use only a dampened cloth when cleaning. Do not allow water to enter the ventilation openings on the projector.
- ▶ If a little water gets into the projector interior while cleaning, leave unplugged in a well-ventilated room for several hours before using.
- ▶ If a lot of water gets into the projector interior when cleaning, have the projector serviced.

## Cleaning the Lens

You can purchase optic lens cleaner from most camera stores. Refer to the following to clean the projector lens.

1. Apply a little optic lens cleaner to a clean soft cloth.  
(Do not apply the cleaner directly to the lens.)
2. Lightly wipe the lens in a circular motion.

Caution:

- ▶ Do not use abrasive cleaners or solvents.
- ▶ To prevent discoloration or fading, avoid getting cleaner on the projector case.

## Cleaning the Case

Refer to the following to clean the projector case.

1. Wipe off dust with a clean dampened cloth.
2. Moisten the cloth with warm water and mild detergent (such as used to wash dishes), and then wipe the case.
3. Rinse all detergent from the cloth and wipe the projector again.

Caution:

To prevent discoloration or fading of the case, do not use abrasive alcohol-based cleaners.

## Compatibility Modes

### Computer Compatibility

Signal	Resolution	Refresh Rate (Hz)
NTSC	-	60
PAL/SECAM	-	50
VESA	640 x 350	70.1 / 85.1
	640 x 400	70.1 / 85.1
	720 x 350	70
	720 x 400	70 / 85
VGA	720 x 576	50 / 60
	640 x 480	60 / 67 / 72.8 / 75 / 85
	800 x 600	56.3 / 60.3 / 75 / 72.2 / 80 / 85.1
SVGA	832 x 624	72 / 75
	1024 x 576	50 / 60
	1024 x 768	60 / 70.1 / 72 / 75 / 85
XGA	1152 x 864	60 / 70 / 75 / 85
	1280 x 720	50 / 60 / 75 / 85
HD720	1280 x 768	60 / 70 / 75 / 85
WXGA	1280 x 800	60
WXGA-800	1280 x 1024	60 / 75 / 85
SXGA	1400 x 1050	60
SXGA+	1600 x 1200	60
	1600 x 1050	60
WUXGA	1920 x 1200	60 / 75
	1920 x 1080	25 / 30
HDTV	1920 x 1080i	50 / 60
	1920 x 1080p	24 / 25 / 30 / 50 / 60
	1280 x 720	60
	1280 x 720p	50 / 60
SDTV	720 x 576	50
	720 x 576i	50
	720 x 576p	50



Signal	Resolution	Refresh Rate (Hz)
	720 x 480	60
	720 x 480i	60
	720 x 480p	60

## Apple Mac Compatibility

Resolution	Macbook		Macbook Pro (Intel)	Power Mac G5	Power Mac G4
	Hz-	Analog	Analog	Analog	Analog
800x600	60	o	o	-	-
800x600	72	o	o	o	o
800x600	75	o	o	o	o
800x600	85	o	o	o	o
1024x768	60	o	o	o	o
1024x768	70	o	o	o	o
1024x768	75	o	o	o	o
1024x768	85	o	o	o	o
1280x720	60	o	o	o	o
1280x720	75	o	o	-	o
1280x720	85	o	o	-	o
1280x768	60	o	o	-	o
1280x768	75	o	o	o	o
1280x768	85	o	o	-	o
1280x800	60	o	o	o	o
1280x1024	60	-	o	o	o
1280x1024	75	-	o	o	-
1680x1050	60	o	o	-	-
1920x1200	60	o	o	-	-



❖ For wide screen resolution (WXGA), the compatibility support is dependent on Notebook/PC models.

## RS232 Commands

### RS232 Connector

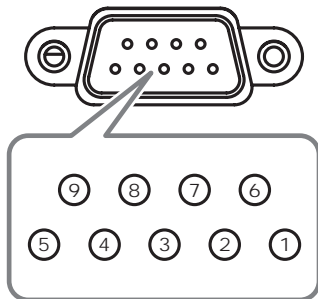

Pin No	Specification
1	N/A
2	RXD
3	TXD
4	DTR
5	GND
6	DSR
7	RTS
8	CTS
9	N/A

## RS232 Protocol Function List

### RS232 Commands

Baud Rate	9600
Data Bits	8
Parity Check	None
Stop Bits	1
Flow Control	None
UART16550 FIFO	Disable

Lead Code	Projector ID		Command ID			space	variable	carriage return
-	X	X	X	X	X		n	CR
Fix code One Digit	Set in OSD 00-99 Two Digit 00 is for universal use		Defined by Optoma 2 or 3 Digit See the Follow content			One Digit	Per item Definition	Fix code One Digit

#### Keypad Command

Function				ASCII	Pass	Fail
Power	On/Off	n=1/n=2 & 0		--XX00 n	P	F
Power On with Password				--XX00 1nnnn	P	F
Resync		n=1		--XX01 n	P	F
AV Mute	On/Off	n=1/n=2 & 0		--XX02 n	P	F
Mute	On/Off	n=1/n=2 & 0		--XX03 n	P	F
Freeze		n=1		--XX04 n	P	F
Unfreeze		n=2				
IR Function	On/Off	n=1/n=2 & 0		--XX11 n	P	F
Direct Source Selection				--XX12 n	P	F
HDMI		n=1				
DVI-D		n=2				
BNC		n=4				
VGA 1		n=5				
VGA 2		n=6				
VGA 1 SCART		n=7				
VGA 1 Component		n=8				
S-Video		n=9				
Video		n=10				
VGA 2 SCART		n=12				
VGA 2 Component		n=13				
Component RCA		n=14				

#### OSD/Image

Function				ASCII	Pass	Fail
Display Mode	Presentation		n=1	--XX20 n	P	F
	Bright		n=2			
	Movie		n=3			
	sRGB		n=4			
	Classroom		n=7			
	Blackboard		n=8			
	User 1		n=5			
	3D		n=11			
Brightness			n= -50 - +50	--XX21 n	P	F
Contrast			n= -50 - +50	--XX22 n	P	F
Sharpness			n= -15 - +15	--XX23 n	P	F



❖ Due to the difference application for each model. Function is dependent on the model purchased.

# Appendices

Function				ASCII	Pass	Fail	
Saturation			n= -50 - +50	-XX45 n	P	F	
Tint			n= -50 - +50	-XX44 n	P	F	
IMAGE /Advanced	BrilliantColor™ <sup>1</sup>		n= 0 - 10	-XX34 n	P	F	
		Degamma	Film	n=1	-XX35 n	P	F
	Video		n=2				
	Graphics		n=3				
	PC		n=4				
	Color Temp.	Warm	n=1	-XX36 n	P	F	
		Medium	n=2				
		Cold	n=3				
	Color Settings	Red	Hue	n=-50 ~ 50	-XX170 n	P	F
			Saturation	n=-50 ~ 50	-XX171 n	P	F
			Gain	n=-50 ~ 50	-XX27 n	P	F
		Green	Hue	n=-50 ~ 50	-XX172 n	P	F
			Saturation	n=-50 ~ 50	-XX173 n	P	F
			Gain	n=-50 ~ 50	-XX28 n	P	F
		Blue	Hue	n=-50 ~ 50	-XX174 n	P	F
			Saturation	n=-50 ~ 50	-XX175 n	P	F
			Gain	n=-50 ~ 50	-XX29 n	P	F
		Cyan	Hue	n=-50 ~ 50	-XX176 n	P	F
			Saturation	n=-50 ~ 50	-XX177 n	P	F
			Gain	n=-50 ~ 50	-XX30 n	P	F
		Yellow	Hue	n=-50 ~ 50	-XX178 n	P	F
			Saturation	n=-50 ~ 50	-XX179 n	P	F
			Gain	n=-50 ~ 50	-XX31 n	P	F
		Magenta	Hue	n=-50 ~ 50	-XX180 n	P	F
			Saturation	n=-50 ~ 50	-XX181 n	P	F
			Gain	n=-50 ~ 50	-XX32 n	P	F
	Reset		n=1	-XX33 n	P	F	
	Color Space	Auto		n=1	-XX37 n	P	F
		RGB		n=2			
		YUV		n=3			
	IMAGE /Advanced	Input Source Filters	HDMI	n=1	-XX39 n	P	F
			DVI-D	n=2			
			BNC	n=4			
VGA 1			n=5				
VGA 2			n=6				
RCA Component			n=8				
S-Video			n=9				
Video			n=10				
IMAGE /Advanced			De-Interlace	On	n=1	-XX40 n	P
	Off	n=2 & 0					

<sup>1</sup> If no patent issue, the term will be modified to BrilliantColor™.

## OSD/Display

Function			ASCII	Pass	Fail
Format	4:3	n=1	-XX60 n	P	F
	16:9 I/16:9	n=2			
	16:9 II / 16:10	n=3			
	Native	n=6			
	Auto	n=7			
Overscan		n=0-10	-XX61 n	P	F
Zoom		n= -30 - +100	-XX62 n	P	F
H Image Shift		n= -50 - +50	-XX63 n	P	F
V Image Shift (16:9)		n= -24 - +24	-XX64 n	P	F
V Keystone		n= -30 - +30	-XX66 n	P	F
3D	Off/DLP-Link	n=2&0, n=1	-XX230 n	P	F
3D Sync Invert	On/Off	n=1/n=2 &0	-XX231 n	P	F

## OSD/Setup

Function			ASCII	Pass	Fail
Language	English	n=1	-XX70 n	P	F
	German	n=2			
	French	n=3			
	Italian	n=4			
	Spanish	n=5			
	Portuguese	n=6			
	Polish	n=7			
	Dutch	n=8			
	Swedish	n=9			
	Norwegian/Danish	n=10			
	Finnish	n=11			
	Greek	n=12			
	Traditional Chinese	n=13			
	Simplified Chinese	n=14			
	Japanese	n=15			
	Korean	n=16			
	Russian	n=17			
	Hungarian	n=18			
	Czechoslovak	n=19			
	Arabic	n=20			
	Thai	n=21			
	Turkish	n=22			
Projection	Front-Desktop	n=1	-XX71 n	P	F
	Rear-Desktop	n=2			
	Front-Ceiling	n=3			
	Rear-Ceiling	n=4			
Menu Location	Top Left	n=1	-XX72 n	P	F
	Top Right	n=2			
	Centre	n=3			
	Bottom Left	n=4			
	Bottom Right	n=5			
Signal	Frequency	n= 0-31	-XX73 n	P	F

# Appendices

Function				ASCII	Pass	Fail
	Phase		n=-5 - +5	-XX74 n	P	F
	H. Position		n=-5 - +5	-XX75 n	P	F
	V. Position		n=-5 - +5	-XX76 n	P	F
Security	Security Timer	Hour/Day/Month	nnnnn	-XX77 n	P	F
	Change Password				send back the password to confirm	
	Security Settings	Enable/Disable	n=1/n=2 &0	-XX78 n	P	F
Projector ID			n=00-99	-XX79 n	P	F
Audio	Mute	On/Off	n=1/n=2 &0	-XX80 n	P	F
	Volume		n=0-10	-XX81 n	P	F
Advanced	Logo	Optoma/User	n=1/n=2	-XX82 n	P	F
	Logo Capture		n=1	-XX83 n	P	F
	Closed Captioning	On/Off	n=1/n=2 &0	-XX88 n	P	F
RS232		RS232	n=1	-XX86 n	P	F
		Network	n=2		P	F

## OSD/Option

Function				ASCII	Pass	Fail
Source Lock		On/Off	n=1/n=2 &0	-XX100 n	P	F
High Altitude		On/Off	n=1/n=2 &0	-XX101 n	P	F
Information Hide		On/Off	n=1/n=2 &0	-XX102 n	P	F
Keypad Lock		On/Off	n=1/n=2 &0	-XX103 n	P	F
Background Color	Blue		n=1	-XX104 n	P	F
	Black		n=2			
	Red		n=3			
	Green		n=4			
	White		n=5			
Advanced	Direct Power On	On/Off	n=1/n=2 &0	-XX105 n	P	F
	Signal Power On	On/Off	n=1/n=2 &0	-XX113 n	P	F
	Auto Power Off (min)		n=0-180	-XX106 n	P	F
	Sleep Timer (min)		n=000-995	-XX107 n	P	F
	Power Mode(Standby)	ECO mode/Active Mode	n=1/n=2 &0	-XX114 n	P	F
Lamp Setting	Lamp Hour		n=1	-XX108 n	nnnn	F
	Lamp Reminder	On/Off	n=1/n=2 &0	-XX109 n	P	F
	Brightness Mode	Bright/STD	n=1/n=2	-XX110 n	P	F
	Lamp Reset	Yes		n=1	-XX111 n	P
No			n=2			
Reset		Yes	n=1	-XX112 n	P	F
		No	n=2			

**Note:** To also include AMX beacon signal in RS232 protocol  
In basic terms, AMX controllers will issue a poll periodically to detect 3rd party devices connected to the RS232 port (in this case Optoma). The poll is "AMX" in ASCII followed by a carriage return "r".

On recognition of the poll, the Optoma projector will respond with a beacon string (in ASCII) identifying your device. The AMX controller (Branded NetLinx) can then download the interface from the amx website to control your device. An example beacon string for Optoma could be:

```
AMXB<-SDKClass=VideoProjector><-Make=Optoma><-Model=EX??><-Revision=1.0.0>
```

The beacon needs to be terminated by a carriage return ('\r', 0x0D)

Revision will indicate the firmware version that is running on the Optoma projector.

Device discovery is also supported over IP if control protocol works across it (most manufacturers take their RS232 command set and also use it for IP on a dedicated application port)

## Information Format: INFOa

Status	Code Definition
Standby Mode	a=0
Warming up	a=1
Cooling Down	a=2
Out of Range	a=3
Lamp Fail	a=4
Thermal Switch Error	a=5
Fan Lock	a=6
Over Temperature	a=7
Lamp Hour Running Out	a=8

## Information display:

Function		ASCII	Display Format	Fail
Information	n=1	-XX150 n	Okabbbbccdddde	F

Format Definition		Code Definition
a = Power State	On	a=1
	Off	a=0
b = Lamp Hour		bbbb
c = Input Source	None	c=0
	HDMI	c=1
	DVI-D	c=2
	BNC	c=3
	VGA 1	c=4
	VGA 2	c=5
	Component RCA	c=6
	S-Video	c=7
d = Firmware Version		c=8
		dddd
e = Display mode	None	e=0
	Presentation	e=1
	Bright	e=2
	Movie	e=3
	sRGB	e=4
	User1	e=5
	User2	e=6
	Classroom	e=7
	Blackboard	e=8

Note: The command -XX150 n MUST work when projector is in standby mode

## Model Name

Function Name		ASCII	Display	Depends	Fail
Model Name	n=1	-XX151 n	Oka	a=1/2/ 1=EX785, 2=EW775	F

## RS232 Version No

Function		ASCII	Display	Depends	Fail
RS232 Version No	n=1	-XX152 n	Oka	a=??	F

## Input Source Display

Function		ASCII	Display	Fail
Input Source	n=1	-XX121 n	Oka	F

Note: The command -XX121 n MUST work when projector is in standby mode

Status	Code Definition
None	c=0
HDMI	c=1
DVI-D	c=2
BNC	c=3
VGA 1	c=4
VGA 2	c=5
Component RCA	c=6
S-Video	c=7
Video	c=8

#### Software Version

Function		ACCII	Display	Fail
Software Version	n=1	~XX122 n	Okdddd	F

#### Display Mode

Function		ACCII	Display	Fail
Display Mode	n=1	~XX123 n	Oka	F

Status	Code Definition
Presentation	a=0
Bright	a=1
Movie	a=2
sRGB	a=3
User 1	a=4
User 2	a=5
Classroom	a=6
Blackboard	a=7

#### Power State

Function		ACCII	Display	Fail
Power State	n=1	~XX124 n	Oka	F

Note: The command ~XX124 n MUST work when projector is in standby mode

Status	Code Definition
On	a=1
Off	a=0

#### Brightness

Function		ACCII	Display	Fail
Brightness	n=1	~XX125 n	Oka	F

#### Contrast

Function		ACCII	Display	Fail
Contrast	n=1	~XX126 n	Oka	F

#### Aspect Ratio

Function		ACCII	Display	Fail
Aspect Ratio	n=1	~XX127 n	Oka	F

Status	Code Definition
4:3	a=0
16:9 I	a=1
16:9 II / 16:10	a=2
Native	a=3
Auto	a=4



## Color Temperature

Function		ASCII	Display	Fail
Color Temperature	n=1	-XX128 n	Oka	F

Status	Code Definition
Warm	a=0
Medium	a=1
Cold	a=2

## Projection Mode

Function		ASCII	Display	Fail
Projection Mode	n=1	-XX129 n	Oka	F

Status	Code Definition
Front-Desktop	a=0
Rear-Desktop	a=1
Front-Ceiling	a=2
Rear-Ceiling	a=3

## Remote control Customer code : 0x32CD

Item	Key Definition		ASCII	Pass	Fail
1	Power	n=1	-XX140 n	P	F
2	Resync	n=2		P	F
3	Keystone	n=3		P	F
4	AV Mute	n=4		P	F
5	Freeze	n=5		P	F
6	Display	n=6		P	F
7	Zoom in	n=7		P	F
8	Zoom out	n=8		P	F
9	Volume +	n=9		P	F
10	Volume -	n=10		P	F
11	Enter (for projection MENU)	n=11		P	F
12	Menu	n=12		P	F
13	Left	n=13		P	F
14	Up	n=14		P	F
15	Right	n=15		P	F
16	Down	n=16		P	F
17	Brightness	n=17		P	F
18	Format/1	n=18		P	F
19	HDMI/2	n=19		P	F
20	YPbPr/3	n=20		P	F
21	Source/4	n=21		P	F
22	DVI/5	n=22		P	F
23	BNC/6	n=23		P	F
24	VGA-1/7	n=24		P	F
25	Video/8	n=25		P	F
26	Video/9	n=26		P	F
27	VGA-2/0	n=27		P	F

## Ceiling Installation



- ❖ Damage to the projector as a result of incorrect installation voids the warranty.

To prevent damage to your projector please use the recommended mounting package for installation.

To ensure compliance, only use a UL Listed ceiling mount and screws that meet the following specifications:

- ▶ Screw Type: M4
- ▶ Maximum screw length: 11 mm
- ▶ Minimum screw length: 9 mm

Refer to the following diagram to ceiling mount the projector.



- ❖ Ensure at least 10cm clearance between the ceiling and the underside of the projector.
- ❖ Avoid locating the projector near heat sources such as air conditioning and heaters. Excess heat may cause the projector to power off.

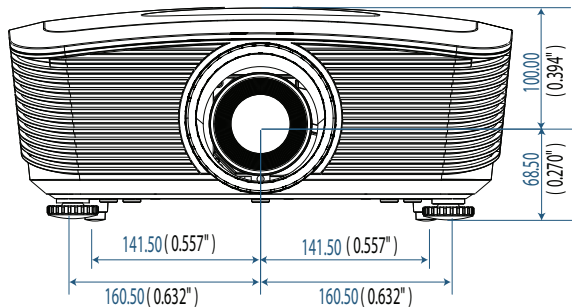
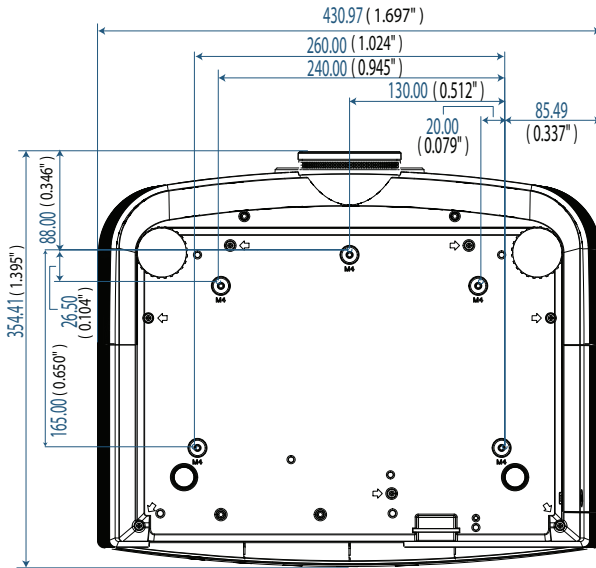

## Optoma Global Offices

*For service or support please contact your local office.*

### USA

715 Sycamore Drive  
Milpitas, CA 95035, USA  
Tel : 408-383-3700  
www.optomausa.com

Fax : 408-383-3702  
Service : [services@optoma.com](mailto:services@optoma.com)

### Canada

5630 Kennedy Road, Mississauga,  
ON, L4Z 2A9, Canada  
Tel : 905-361-2582  
www.optoma.ca

Fax : 905-361-2581  
Service : [canadacsragent@optoma.com](mailto:canadacsragent@optoma.com)

### Europe

42 Caxton Way, The Watford Business Park  
Watford, Hertfordshire, WD18 8QZ, UK  
Tel : +44 (0) 1923 691 800  
www.optoma.eu  
Service Tel : +44 (0)1923 691865

Fax : +44 (0) 1923 691 888  
Service : [service@tsc-europe.com](mailto:service@tsc-europe.com)

### France

Bâtiment E 81-83 avenue Edouard Vaillant  
92100 Boulogne Billancourt, France  
Tel.: +33 1 41 46 12 20  
Service : [savoptoma@optoma.fr](mailto:savoptoma@optoma.fr)

Fax : +33 1 41 46 94 35

### Spain

C/ José Hierro, 36 Of, 1C  
28529 Rivas Vacia, Madrid, Spain  
Tel.: +34 91 499 06 06

Fax : +34 91 670 08 32

### Deutschland

Werftstrasse 25 D40549  
Düsseldorf, Germany  
Tel : +49 (0) 211 506 6670  
Service : [info@optoma.de](mailto:info@optoma.de)

Fax : +49 (0) 211 506 66799

## Scandinavia

Grev Wedels Plass 2  
3015 Drammen, Norway  
Tel : +47 32 26 89 90  
Service : [info@optoma.no](mailto:info@optoma.no)

Fax : +47 32 83 78 98

## Latin America

715 Sycamore Drive  
Milpitas, CA 95035, USA  
Tel : 408-383-3700  
[www.optoma.com.br](http://www.optoma.com.br)

Fax : 408-383-3702  
[www.optoma.com.mx](http://www.optoma.com.mx)

## Korea

WOOMI TECH.CO.,LTD  
4F,Minu Bldg.3.tw3-14, Kangnam-Ku, seoul,135-815, KOREA  
Tel : +82+2+34430004  
Fax : +82+2+34430005

## Japan

東京都足立区綾瀬3-25-18  
株式会社オーエスエム  
サポートセンター:0120-46-5040  
E-mail : [info@osscreen.com](mailto:info@osscreen.com)

[www.os-worldwide.com](http://www.os-worldwide.com)

## Taiwan

5F., No. 108, Minchiuan Rd., Shindian City,  
Taipei Taiwan 231, R.O.C.  
Tel : +886-2-2218-2360  
[www.optoma.com.tw](http://www.optoma.com.tw)  
Service : [services@optoma.com.tw](mailto:services@optoma.com.tw)

Fax : +886-2-2218-2313  
[asia.optoma.com](http://asia.optoma.com)

## Hong Kong

Unit A, 27/F Dragon Centre, 79 Wing Hong Street,  
Cheung Sha Wan, Kowloon, Hong Kong  
Tel : +852-2396-8968  
[www.optoma.com.hk](http://www.optoma.com.hk)  
Fax : +852-2370-1222

## China

5F, No. 1205, Kaixuan Rd., Changning District  
Shanghai, 200052, China  
Tel : +86-21-62947376  
[www.optoma.com.cn](http://www.optoma.com.cn)  
Fax : +86-21-62947375

## Regulation & Safety notices

This appendix lists the general notices of your projector.

### FCC notice

This device has been tested and found to comply with the limits for a Class B digital device pursuant to Part 15 of the FCC rules. These limits are designed to provide reasonable protection against harmful interference in a residential installation. This device generates, uses, and can radiate radio frequency energy and, if not installed and used in accordance with the instructions, may cause harmful interference to radio communications.

However, there is no guarantee that interference will not occur in a particular installation. If this device does cause harmful interference to radio or television reception, which can be determined by turning the device off and on, the user is encouraged to try to correct the interference by one or more of the following measures:

- ▶ Reorient or relocate the receiving antenna.
- ▶ Increase the separation between the device and receiver.
- ▶ Connect the device into an outlet on a circuit different from that to which the receiver is connected.
- ▶ Consult the dealer or an experienced radio/television technician for help.

### ***Notice: Shielded cables***

All connections to other computing devices must be made using shielded cables to maintain compliance with FCC regulations.

### ***Caution***

Changes or modifications not expressly approved by the manufacturer could void the user's authority, which is granted by the Federal Communications Commission, to operate this projector.

## Operation conditions

This device complies with Part 15 of the FCC Rules. Operation is subject to the following two conditions:

1. This device may not cause harmful interference, and
2. This device must accept any interference received, including interference that may cause undesired operation.

### Notice: Canadian users

This Class B digital apparatus complies with Canadian ICES-003.

### Remarque à l'intention des utilisateurs canadiens

Cet appareil numérique de la classe B est conforme à la norme NMB-003 du Canada.

### Declaration of Conformity for EU countries

- ▶ EMC Directive 2004/108/EC (including amendments)
- ▶ Low Voltage Directive 2006/95/EC
- ▶ R & TTE Directive 1999/5/EC (if product has RF function)

## Disposal instructions



**Do not throw this electronic device into the trash when discarding. To minimize pollution and ensure utmost protection of the global environment, please recycle it.**