

ViewSonic®

PJL7200/PJL7201/PJL7202 LCD Projector

IMPORTANT: Please read this User Guide to obtain important information on installing and using your product in a safe manner, as well as registering your product for future service. Warranty information contained in this User Guide will describe your limited coverage from ViewSonic Corporation, which is also found on our web site at <http://www.viewsonic.com> in English, or in specific languages using the Regional selection box in the upper right corner of our website.

"Antes de operar su equipo lea cuidadosamente las instrucciones en este manual"



- User Guide
- Guide de l'utilisateur
- Bedienungsanleitung
- Guía del usuario
- Guida dell'utente
- Guia do usuário
- Användarhandbok
- Käyttöopas
- Руководство пользователя
- 使用手冊 (繁體)
- 使用手冊 (简体)
- 사용자 안내서
- คู่มือการใช้งาน
- Керівництво користувача

Model No. : VS12186
VS12199
VS12234

Compliance Information

FCC Statement

This device complies with part 15 of FCC Rules. Operation is subject to the following two conditions: (1) this device may not cause harmful interference, and (2) this device must accept any interference received, including interference that may cause undesired operation.

This equipment has been tested and found to comply with the limits for a Class B digital device, pursuant to part 15 of the FCC Rules. These limits are designed to provide reasonable protection against harmful interference in a residential installation. This equipment generates, uses, and can radiate radio frequency energy, and if not installed and used in accordance with the instructions, may cause harmful interference to radio communications. However, there is no guarantee that interference will not occur in a particular installation. If this equipment does cause harmful interference to radio or television reception, which can be determined by turning the equipment off and on, the user is encouraged to try to correct the interference by one or more of the following measures:

- Reorient or relocate the receiving antenna.
- Increase the separation between the equipment and receiver.
- Connect the equipment into an outlet on a circuit different from that to which the receiver is connected.
- Consult the dealer or an experienced radio/TV technician for help.

Warning: You are cautioned that changes or modifications not expressly approved by the party responsible for compliance could void your authority to operate the equipment.

For Canada

- This Class B digital apparatus complies with Canadian ICES-003.
- Cet appareil numérique de la classe B est conforme à la norme NMB-003 du Canada.

CE Conformity for European Countries

 The device complies with the requirements of the EEC directive 2004/108/EC as amended by 92/31/EEC and 93/68/EEC Art.5 with regard to “Electromagnetic compatibility”, and 2006/95/EC as amended by 93/68/EEC Art.13 with regard to “Safety.”

Following information is only for EU-member states:

The mark shown to the right is in compliance with the Waste Electrical and Electronic Equipment Directive 2002/96/EC (WEEE).

The mark indicates the requirement NOT to dispose the equipment as unsorted municipal waste, but use the return and collection systems according to local law.



Important Safety Instructions

1. Read these instructions.
2. Keep these instructions.
3. Heed all warnings.
4. Follow all instructions.
5. Do not use this unit near water.
6. Clean with a soft, dry cloth. If still not clean, see “Cleaning the Display” in this guide for further instructions.
7. Do not block any ventilation openings. Install the unit in accordance with the manufacturer’s instructions.
8. Do not install near any heat sources such as radiators, heat registers, stoves, or other devices (including amplifiers) that produce heat.
9. Do not defeat the safety purpose of the polarized or grounding-type plug. A polarized plug has two blades with one wider than the other. A grounding type plug has two blades and a third grounding prong. The wide blade and the third prong are provided for your safety. If the provided plug does not fit into your outlet, consult an electrician for replacement of the obsolete outlet.
10. Protect the power cord from being walked on or pinched particularly at plugs. Convenience receptacles and the point where they exit from the unit. Be sure that the power outlet is located near the unit so that it is easily accessible.
11. Only use attachments/accessories specified by the manufacturer.
12.  Use only with the cart, stand, tripod, bracket, or table specified by the manufacturer, or sold with the unit. When a cart is used, use caution when moving the cart/unit combination to avoid injury from tipping over.
13. Unplug this unit when unused for long periods of time.
14. Refer all servicing to qualified service personnel. Servicing is required when the unit has been damaged in any way, such as: if the power-supply cord or plug is damaged, if liquid is spilled onto or objects fall into the unit, if the unit is exposed to rain or moisture, or if the unit does not operate normally or has been dropped.

Declaration of RoHS Compliance

This product has been designed and manufactured in compliance with Directive 2002/95/EC of the European Parliament and the Council on restriction of the use of certain hazardous substances in electrical and electronic equipment (RoHS Directive) and is deemed to comply with the maximum concentration values issued by the European Technical Adaptation Committee (TAC) as shown below:

| Substance | Proposed Maximum Concentration | Actual Concentration |
|---|---------------------------------------|-----------------------------|
| Lead (Pb) | 0.1% | < 0.1% |
| Mercury (Hg) | 0.1% | < 0.1% |
| Cadmium (Cd) | 0.01% | < 0.01% |
| Hexavalent Chromium (Cr ⁶⁺) | 0.1% | < 0.1% |
| Polybrominated biphenyls (PBB) | 0.1% | < 0.1% |
| Polybrominated diphenyl ethers (PBDE) | 0.1% | < 0.1% |

Certain components of products as stated above are exempted under the Annex of the RoHS Directives as noted below:

Examples of exempted components are:

1. Mercury in compact fluorescent lamps not exceeding 5 mg per lamp and in other lamps not specifically mentioned in the Annex of RoHS Directive.
2. Lead in glass of cathode ray tubes, electronic components, fluorescent tubes, and electronic ceramic parts (e.g. piezoelectronic devices).
3. Lead in high temperature type solders (i.e. lead-based alloys containing 85% by weight or more lead).
4. Lead as an alloying element in steel containing up to 0.35% lead by weight, aluminium containing up to 0.4% lead by weight and as a copper alloy containing up to 4% lead by weight.

Copyright Information

Copyright © ViewSonic Corporation, 2008. All rights reserved.

Macintosh and Power Macintosh are registered trademarks of Apple Inc.

Microsoft, Windows, Windows NT, and the Windows logo are registered trademarks of Microsoft Corporation in the United States and other countries.

ViewSonic, the three birds logo, OnView, ViewMatch, and ViewMeter are registered trademarks of ViewSonic Corporation.

VESA is a registered trademark of the Video Electronics Standards Association. DPMS and DDC are trademarks of VESA.

PS/2, VGA and XGA are registered trademarks of International Business Machines Corporation.

Disclaimer: ViewSonic Corporation shall not be liable for technical or editorial errors or omissions contained herein; nor for incidental or consequential damages resulting from furnishing this material, or the performance or use of this product.

In the interest of continuing product improvement, ViewSonic Corporation reserves the right to change product specifications without notice. Information in this document may change without notice.

No part of this document may be copied, reproduced, or transmitted by any means, for any purpose without prior written permission from ViewSonic Corporation.

Product Registration

To meet your future needs, and to receive any additional product information as it becomes available, please register your product on the Internet at: www.viewsonic.com. The ViewSonic® Wizard CD-ROM also provides an opportunity for you to print the registration form, which you may mail or fax to ViewSonic.

For Your Records

| | |
|-------------------------|--|
| Product Name: | PJL7200/PJL7201/PJL7202 ViewSonic LCD Projector |
| Model Number: | VS12186/VS12199/VS12234 |
| Document Number: | PJL7200_PJL7201_PJL7202_UG_ENG Rev. 1B 12-04-08 |
| Serial Number: | _____ |
| Purchase Date: | _____ |



The lamp in this product contains mercury.

Please dispose of in accordance with local, state or federal laws.

Projector

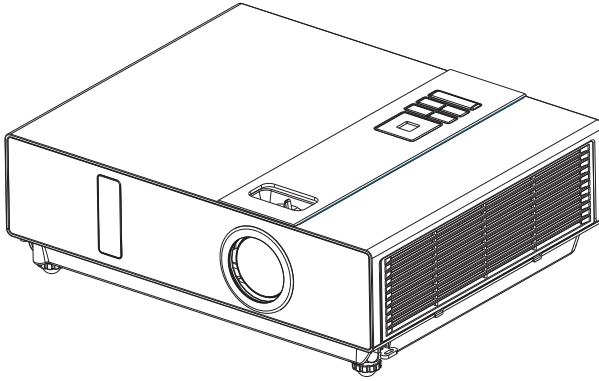

About the Owner's Manual

Please read the owner's manual thoroughly to ensure correct usage of the projector and its features.

After reading, store the owner's manual in a safe place for future reference.

Features

1. Dress up Design
2. Designed for tough environment
3. Side change lamp
4. Side change filter
5. Quick off
6. Advanced Anti-theft features
7. Five auto features (Auto Search, Auto Sync, Auto Ceiling, Auto Keystone and Auto on)
8. Six display modes (Natural, Cinema, Daylight, Green board, White Board, Black Board)
9. Built-in 8W speaker
10. User logo capture
11. Image freeze function
12. Digital zoom adjustment

The content of this manual is subject to change without previous notice.

All rights reserved.

Issue of edition 0806.03_01

Contents

About Owner's Manual

| | |
|---|------------|
| Contents | 1 |
| Contents of Your Box | 3-A |
| Safety Instructions | 4 |
| Safety Labels | 5 |
| Part Names | 6 |
| Projector..... | 6 |
| Control Panel | 7 |
| Rear..... | 8 |
| Setting Up | 9 |
| Arrangement | 9 |
| Power ON / OFF..... | 10 |
| Setting Up The Projector | 11 |
| Ceiling Mounted Installation Guide | 12 |
| Adjusting The Projector's Elevation | 13 |
| How To Connect..... | 14 |
| Remote Control | 16 |
| Menu Operation | 18 |
| How To Operate On-Screen Display | 18 |
| MENU (PC Mode) | 19 |
| Picture Menu (PC Mode)..... | 19 |
| Audio Menu (PC Mode)..... | 20 |
| Image Menu (PC Mode)..... | 21 |
| MENU (Video Mode) | 22 |
| Picture Menu (Video Mode)..... | 22 |
| Audio Menu (Video Mode)..... | 23 |
| Image Menu (Video Mode)..... | 24 |

Contents

| | |
|---|-----------|
| MENU | 25 |
| Setting Menu..... | 25 |
| Option Menu..... | 29 |
| Advanced Menu..... | 30 |
| PIN Key In Operation..... | 32 |
| Network Control Software Application (Optional)..... | 33 |
| Before Use | 34 |
| Before To Use Network Control Software | 34 |
| Projector Auto Search..... | 35 |
| Modify the Projector Setting | 37 |
| Registering And Configuring the Projector..... | 38 |
| Delete..... | 38 |
| Projector Setting | 39 |
| System Setting / Monitor / Default Setting / Auto Detect Optimal Setting..... | 40 |
| Link..... | 42 |
| Control Panel Window Introduction..... | 43 |
| Power Control / Input Source / Function Key | 43 |
| Function Key / Projector Status..... | 44 |
| Network Control Window Introduction..... | 45 |
| Maintenance Of Projector..... | 46 |
| Air Filter / Replacing the Air Filter | 46 |
| Lamp / Replacing New Lamp..... | 47 |
| Other Care / Cleaning the Lens | 48 |
| Troubleshooting..... | 49 |
| Indicator..... | 49 |
| Error For Machine Defects | 50 |
| List of Supported Monitor Displays | 52 |
| Appendix | |

Contents of Your Box

Check-list of your accessories

Please make sure that following items are included in the box, along with the main. If any items missing, contact your dealer.

1. Projector

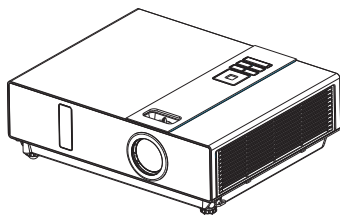

2. Remote control



3. Power cord

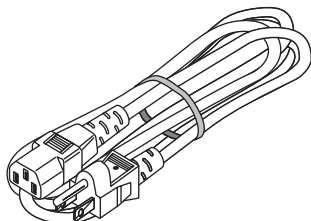

4. Computer cable

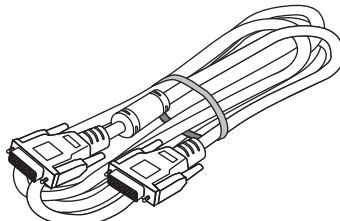

5. USB Cable (1.5M)

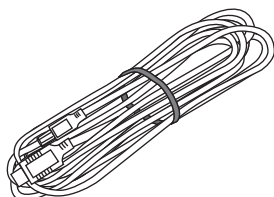

6. Quick Start Guide



Contents of Your Box

7. Owner's Manual CD



8. Network Control Application CD (Optional)



9. Soft Bag



Safety Instructions

The projector is designed and tested to meet the latest standards for safety of information technology equipment. However, to ensure safe use of this product, it is important that you follow the instructions mentioned in this manual and marked on the product.



WARNING / CAUTION

1. If a problem occurs

- If smoke or strange odors arise, continued use could result in fire or electrical shock.
- If there is no image or sound, or the sound is distorted in the projector. In some cases, immediately remove the power cable from the power outlet. After making sure that the unit has stopped, contact your dealer for repairs. Never attempt to repair by yourself because this is dangerous.

2. Do....

- Place the projector in a stable horizontal position.
- Put the projector in a cool place, and ensure that there is sufficient ventilation.
- To consult with your dealer before a special installation such as suspending from a ceiling.

3. Do not....

- Do not place the projector on an unstable, slanted or vibrating surface such as a wobbly or inclined stand.
- Do not cover the projector's vents. Keep a space of 20 cm or more between the projector and other objects such as walls.
- Do not place the projector on metallic goods.
- Do not place the projector on carpet, cushions or bedding. Do not place the projector in direct sunlight or near hot objects such as heaters.
- Do not place anything near the projector lens or vents, or on top of the projector.
- Do not place anything that may be sucked into or stick to the vents beside of the projector.
- Do not use this projector if there is no image or sound, or if the sound is distorted.
- Do not place this projector in a container containing liquid.

4. While connecting, make sure that the shape of the cable's connector fits the port to connect with. Be sure to tighten the screws on connectors with screws.
5. Do not disassemble or modify the projector and accessories.
6. Be careful not to damage the cables, and do not use damaged cables.
7. Use appropriate accessories or otherwise designed cables. Ask your dealer about non-accessory cables that may have other lengths.
8. Make sure that devices are connected to the correct ports. An incorrect connection may result in malfunction or damage to the device and the projector.
9. Do not look through the lens when the lamp is on.

Do not look through the lens when the lamp is on. The powerful light could adversely affect vision. Use special caution in households where children are present.

10. A strong light is emitted when the projector's power on. Do not look into the lens of the projector or look inside of the projector.



Do not place the projector upon either side to project an image.

NO SIDeward



Do not point the projector down to project an image.

NO DOWNward

Safety Labels

Safety labels are used on or within the projector to alert you to items or areas requiring your attention.

WARNING LABEL

| | | |
|--|---|--|
| <p>⚠ WARNING ⚠</p> <p>• BEFORE OPERATING, PLEASE READ USER'S MANUAL.</p> <p>• BEFORE REMOVING SCREWS, DISCONNECT POWER CABLE.</p> <p>• DO NOT BLOCK VENTING OPENINGS.</p> | <p>⚠ WARNUNG ⚠</p> <p>• VOR DEM EINSATZ DIE BEDIENUNGSANLEITUNG LESEN.</p> <p>• VOR DEM ENTFERNEN DER SCHRAUBEN DAS NETZKABEL ABTRENNEIN.</p> <p>• LUFTUNGSÖFFNUNGEN NICHT BLOCKIEREN.</p> | <p>⚠ AVIS ⚠</p> <p>• VEUILLEZ LIRE LE MODE D'EMPLOI AVANT L'USAGE.</p> <p>• DÉBRANCHER LE CÂBLE D'ALIMENTATION AVANT DE RETIRER LES VIS.</p> <p>• NE BOUCHEZ PAS LES ORIFICES DE VENTILATION.</p> |
| <p>⚠ 警告 ⚠</p> <p>• 本製品は正しい取扱説明書が読取れない。 • 誤作動による事故がないように。 • 多少の衝撃に十分注意し、必ず電源プラグをコンセントから抜いてください。</p> | <p>⚠ 警告 ⚠</p> <p>• 操作前、必ず取扱説明書を読取。 • 部品を取り除く前に電源ケーブルを抜く。 • 排気口を塞ぎ、空気の流れを妨げない。</p> | <p>⚠ 警告 ⚠</p> <p>• 操作前、必ず取扱説明書を読取。 • 部品を取り除く前に電源ケーブルを抜く。 • 排気口を塞ぎ、空気の流れを妨げない。</p> |

(USA ONLY) This product contains mercury. Disposal of mercury may be regulated due to environmental considerations. For disposal or recycling information, please contact your local authorities or the Electronic Industries Alliance: www.eia.org

EMI LABEL

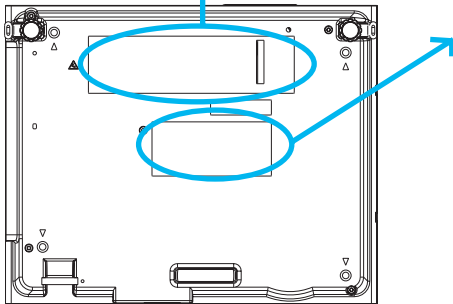

ViewSonic PJL7200
LCD Projector
Model: VS1218S

ViewSonic Corporation
381 Brea Canyon Road, Walnut, CA 91789 USA

INPUT AC 100-240V, 50/60Hz, 3.5-1.5A
Serial No.:
XXXXXXXXXXXXXXXXXX

GP CE **UL US LISTED L1E E237081**

Tested To Comply With FCC Standards FOR HOME OR OFFICE USE

CAUTION: Do not open. No user-serviceable parts inside.
Cuidado: no abra la tapa. Ninguna parte interna es reparable por Usuario

Made in Taiwan

ViewSonic PJL7201
LCD Projector
Model: VS12199

ViewSonic Corporation
381 Brea Canyon Road, Walnut, CA 91789 USA

INPUT AC 100-240V, 50/60Hz, 3.5-1.5A
Serial No.:
XXXXXXXXXXXXXXXXXX

GP CE **UL US LISTED L1E E237081**

Tested To Comply With FCC Standards FOR HOME OR OFFICE USE

CAUTION: Do not open. No user-serviceable parts inside.
Cuidado: no abra la tapa. Ninguna parte interna es reparable por Usuario

Made in Taiwan

ViewSonic PJL7202
LCD Projector
Model: VS12234

ViewSonic Corporation
381 Brea Canyon Road, Walnut, CA 91789 USA

INPUT AC 100-240V, 50/60Hz, 3.5-1.5A
Serial No.:
XXXXXXXXXXXXXXXXXX

GP CE **UL US LISTED L1E E237081**

Tested To Comply With FCC Standards FOR HOME OR OFFICE USE

CAUTION: Do not open. No user-serviceable parts inside.
Cuidado: no abra la tapa. Ninguna parte interna es reparable por Usuario

Made in Taiwan

LAMP DOOR WARNING LABEL

| | |
|---|---|
| <p>⚠ CAUTION HOT</p> <p>TURN THE POWER OFF AND WAIT 1 HOUR BEFORE CHANGING THE LAMP.</p> <p>WARNUNG HEISS!</p> <p>SCHALTEN SIE DAS GERÄT AUS UND WARTEN SIE 1 STUNDE BIS SIE DIE LAMPE WECHSELN.</p> | <p>ATTENTION CHAUD</p> <p>COUPER L'ALIMENTATION ET ATTENDRE 1 HEURE AVANT DE CHANGER LA LAMPE.</p> <p>高温注意</p> <p>ランプ交換は、電源を切った後、1時間待ってから行ってください。 実用投影機使用前、必ず冷却至少1小时后才进行更换灯泡。</p> |
| <p>⚠ CAUTION</p> <p>HIGH-PRESSURE LAMP MAY EXPLODE IF IMPROPERLY HANDLED.</p> <p>REPLACE WITH SAME TYPE NUMBER LAMP.</p> <p>DO NOT CLEAN THE AIR FILTER WITH WATER OR ANY LIQUID.</p> <p>DO NOT OPERATE THE PROJECTOR WITHOUT THE AIR FILTER.</p> <p>VORSICHT!</p> <p>DIE HOCHDRUCKLAMPE KANN BEI FALSCHER HANDHABUNG EXPLODIEREN.</p> <p>NUR MIT EINER LAMPE DES GLEICHEN TYPUS AUSTAUSCHEN.</p> <p>VERWENDEN SIE ZUR REINIGUNG DES LUFTFILTERS WEDER WASSER NOCH ANDERE FLÜSSIGKEITEN.</p> <p>BETRIEBEN SIE IHREN PROJEKTOR NICHT OHNE DEN LUFTFILTERS.</p> | <p>ATTENTION</p> <p>LA LAMPE À HAUTE PRESSION PEUT EXPLOSER SI ELLE EST MANIPULÉE INCORRECTEMENT.</p> <p>REMPLEZ PAR UNE LAMPE AVEC UN NUMERO DE TYPE IDENTIQUE.</p> <p>N'UTILISEZ PAS D'EAU NI UN AUTRE LIQUIDE POUR NETTOYER LE FILTRE À AIR.</p> <p>NE FAITES PAS FONCTIONNER VOTRE PROJECTEUR SANS LE FILTRE À AIR.</p> <p>注意</p> <p>ランプは、同じタイプのもので交換してください。 誤った取り扱いをしたときに、高圧ランプが破裂する恐れがあります。 水や油などで洗わないでください。 フィルタをはずした状態で電源を入れないでください。 如果不正当地处理灯泡也许会致爆裂。 请使用同类型的灯泡。 请不要用水或油清洗和冲洗滤网。 没有装置滤网，请勿操作投影机。</p> |

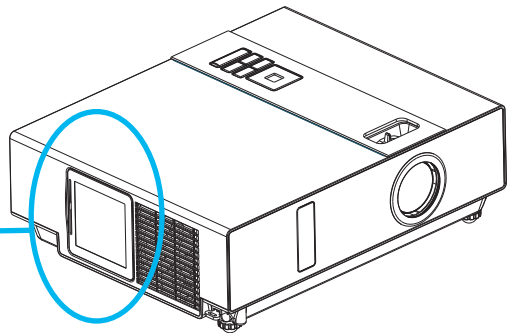

Projector

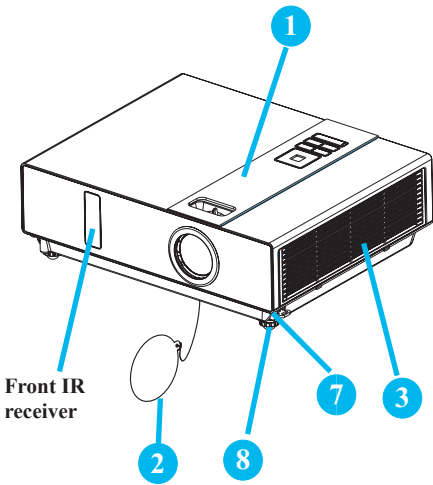

Front IR receiver

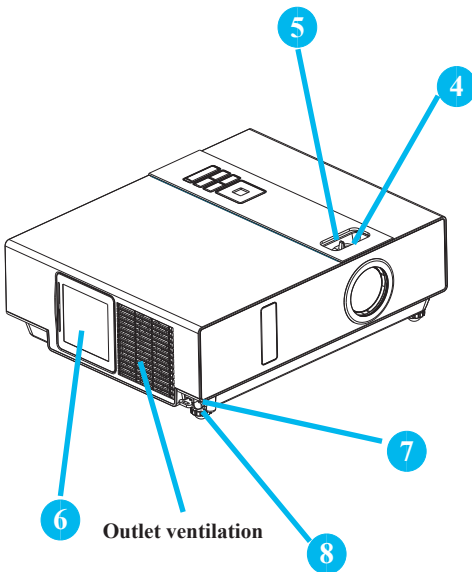

Outlet ventilation

1 Control panel

Operating system.

2 Lens cover

Attach when not using to protect the lens from becoming dirty or damaged.

3 Filter cover

Prevents dust and other foreign particles from being drawn into projector.

Remove the filter cover to clean the air filter.

4 Focus ring

Use the focus ring to focus the projector image.

Rotate the focus ring until the image is clear.

5 Zoom ring

Use the zoom ring to adjust the size of the projected image.

Rotate the zoom ring until the image is the desired size.

6 Lamp door

The lamp unit is inside.

7 Foot adjust button

Lock / unlock the adjustable foot.

8 Front adjustable foot

Extend and retract to adjust the projection angle.

Control Panel

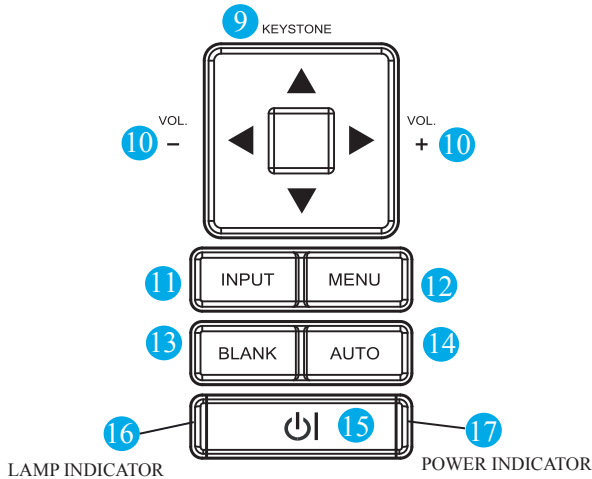

9 KEYSTONE

Adjust the vertical keystone with menu-up, menu-down.

10 VOLUME + / -

Sound louder or lower.

11 INPUT

Select input source:

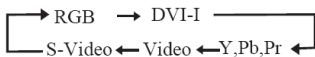

12 MENU

Display or hide the On-Screen Display main menu page.

13 BLANK

Blanks the projected image. If the projector is left in blank mode for more than 15 minutes, the projector will automatically shut down.

14 AUTO

Automatically adjust the setting to match the current input.

15 (POWER)

Power on / operation mode, Standby mode, Cooling-down mode.

16 LAMP INDICATOR

Indicates a status in the internal projector temperature, lamp door properly closed or cooling down.

17 POWER INDICATOR

Light on or flash to indicate the operating status of the projector.

Rear

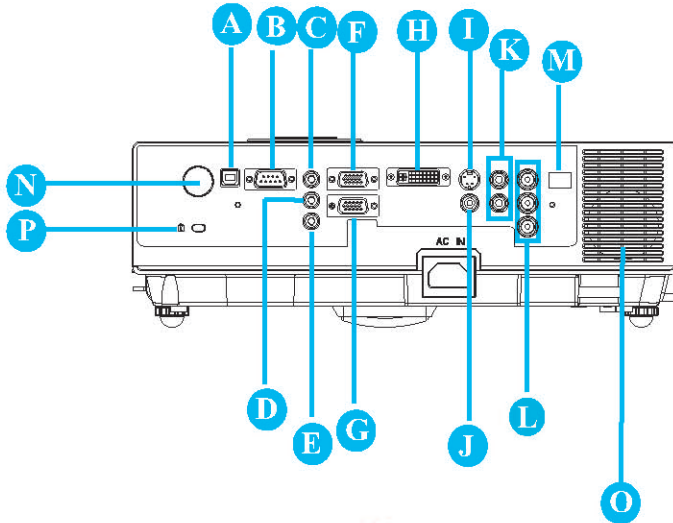

A MOUSE

Connect a USB mouse cable to a computer to control computer mouse functions.

B RS232

Serial data port for controlling the projector with a computer or other RS-232 control device.

C Audio IN 1 & D Audio IN 2

Mini jack port corresponds to computer input.

E Audio Out

F RGB IN

Input analog RGB video signal from a computer.

G RGB OUT

Connect an external monitor to this connection to view the “RGB IN” input.

H DVI-I IN

Input digital DVI-I signal from a computer.

I S-VIDEO

S-Video signal from a video source.

J VIDEO

Component video signal from a video source.

K AUDIO IN 3, R / L

Stereo mini jack corresponds to video input.

L COMPONENT, Y / Pb / Pr

Input Y,Pb,Pr signal from a DVD player.

M LAN (Optional)

This function is optional.

Please see page 33 Network Control Application for details.

N Rear IR receiver

O SPEAKER

P Slot for Kensington Micro Saver

Security System

Built-in Security Slot. This security slot supports the MicroSaver® Security System. MicroSaver® is a registered trademark of Kensington Microware Inc. The logo is trademarked and owned by Kensington Microware Inc.

Setting Up

Arrangement

1. Before installation, make sure that the projector is turned off and the power cord is disconnected.
2. Do not set up and move the projector, while it is hot.
3. The distance between the projector and screen determines the actual image size. Refer to the table below to determine the screen size at a given distance.

Note: The dimensions in the table below are approximate.

| 4:3 Screen size (diagonal) | | Distance (m) | | Distance (feet) | |
|----------------------------|------|--------------|------|-----------------|-------|
| inch | m | Tele | Wide | Tele | Wide |
| 40 | 1.0 | 1.37 | 1.11 | 4.49 | 3.64 |
| 50 | 1.25 | 1.72 | 1.4 | 5.65 | 4.61 |
| 60 | 1.5 | 2.08 | 1.7 | 6.81 | 5.58 |
| 70 | 1.8 | 2.43 | 2.00 | 7.97 | 6.54 |
| 80 | 2.0 | 2.78 | 2.29 | 9.13 | 7.51 |
| 90 | 2.25 | 3.14 | 2.59 | 10.29 | 8.48 |
| 100 | 2.5 | 3.49 | 2.88 | 11.45 | 9.45 |
| 150 | 3.8 | 5.26 | 4.36 | 17.26 | 14.29 |
| 200 | 5.1 | 7.03 | 5.83 | 23.06 | 19.13 |
| 250 | 6.4 | 8.80 | 7.31 | 28.87 | 23.98 |
| 300 | 7.6 | 10.57 | 8.79 | 34.67 | 28.82 |

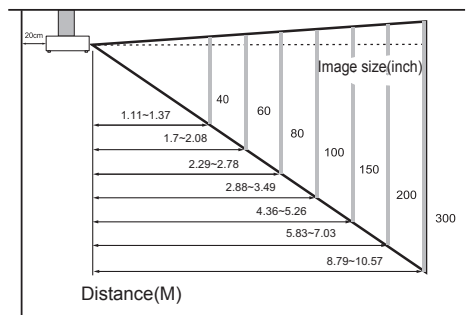
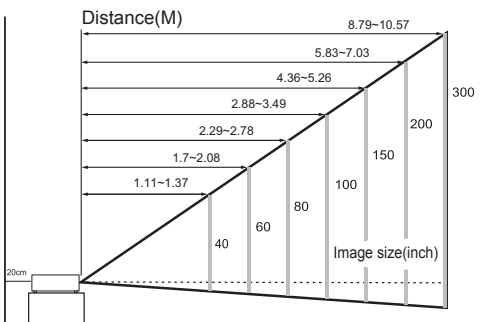

When in against at wall, leave about 20cm (7.9in.) Between thw projector and the wall.

Setting Up

Power ON / OFF

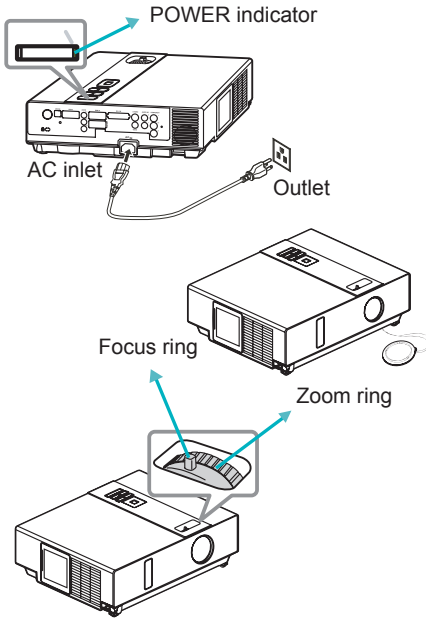

Turning on the power

1. Make sure that power cord is firmly and correctly connected to the projector.
2. Remove the lens cover, and the POWER indicator will light up in green.
3. Press POWER button on the control panel or the remote control to turn on the projector.
4. Rotate the zoom ring to adjust the screen size.
5. Rotate the focus ring to adjust the focus.

WARNING

- ★ A strong light is emitted when the projector's power is on. Do not look into the lens of the projector or look inside of the projector through any of the projector's openings.



Power off?

Please press



key again to power off.

Turning off the power

1. Press the POWER button on the control panel or the remote control. The “power off” confirmation message appears.
2. Press the POWER button again while the message appears.
3. When the projector enters “Standby” mode, the POWER indicator will light up in green.
4. If you don't use the projector, remove power cord.

WARNING

- ★ Do not touch around the lamp cover and the exhaust vents during use or just after use, since it is too hot.

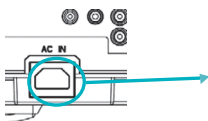
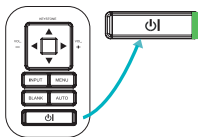

Setting Up

Setting Up The Projector

The projector supports the following four different projection methods.

1. Front projection

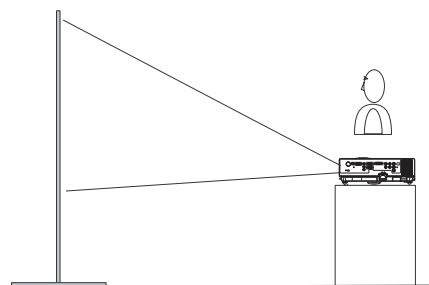

3. Rear ceiling projection

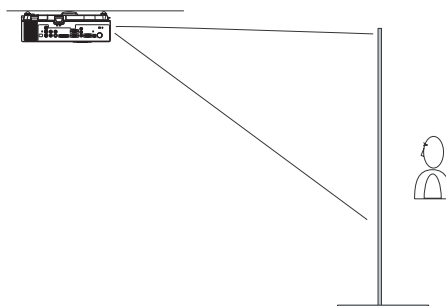

2. Rear projection

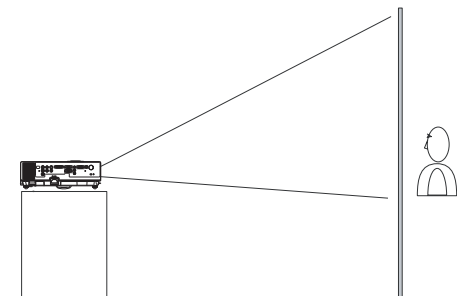

4. Front ceiling projection

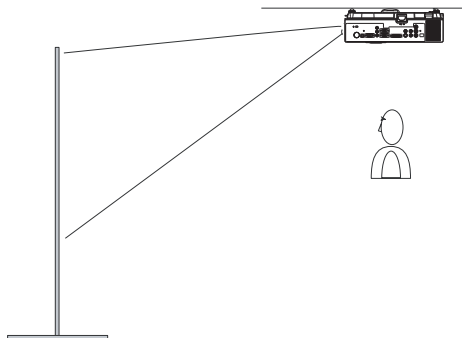

Special installation is required in order to suspend the projector from the ceiling. Please ask your dealer for details.

Ceiling Mounted Installation Guide

Attach ceiling mount at four-suspension bracket fixing points when suspending from a ceiling. Special installation is required in order to suspend the projector from the ceiling. Please ask your dealer for details.

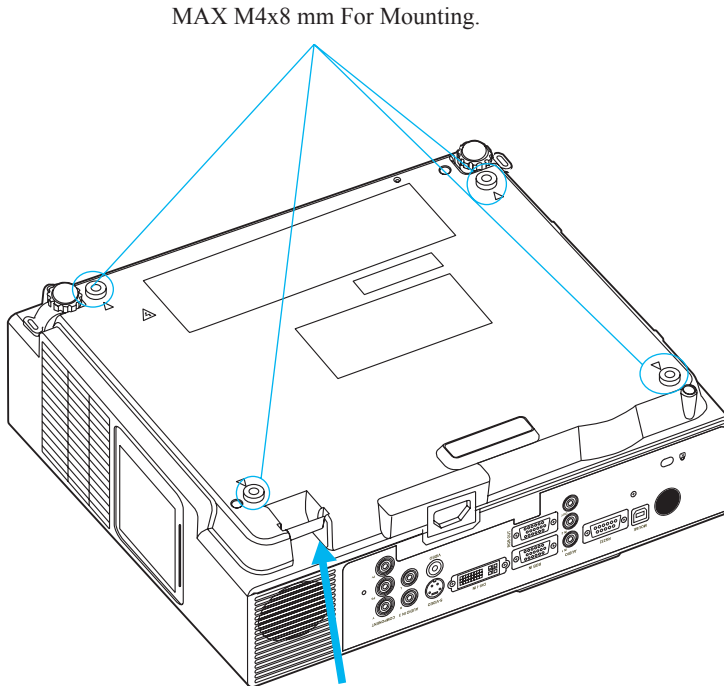

Security Anchor

The product is equipped with security anchor and PIN LOCK functions to help prevent unauthorized removal projector.

WARNING

- ▶ Do not grasp the security anchor to carry projector, since it is not designed for it.
- ▶ The security anchor is not for comprehensive theft prevention measures. It is intended to be used as supplemental theft prevention measure.

Adjusting The Projector's Elevation

Use the adjustable foot at the front of the projector to set the image height.

- 1 Holding the projector, push the foot adjust buttons to loosen the front adjustable foot.
- 2 Position the front side of the projector to the desired height.
- 3 Release the foot adjust buttons in order to lock the front adjustable feet.
- 4 After making sure that the front adjustable feet are locked, put the projector gently atop.

CAUTION

- * The adjustment range of front adjustable foot is 0 to 8.5 degrees.
- * When the foot is adjusted, it may cause the shape of the projected image to become distorted. Use the keystone correction function to correct this distortion.

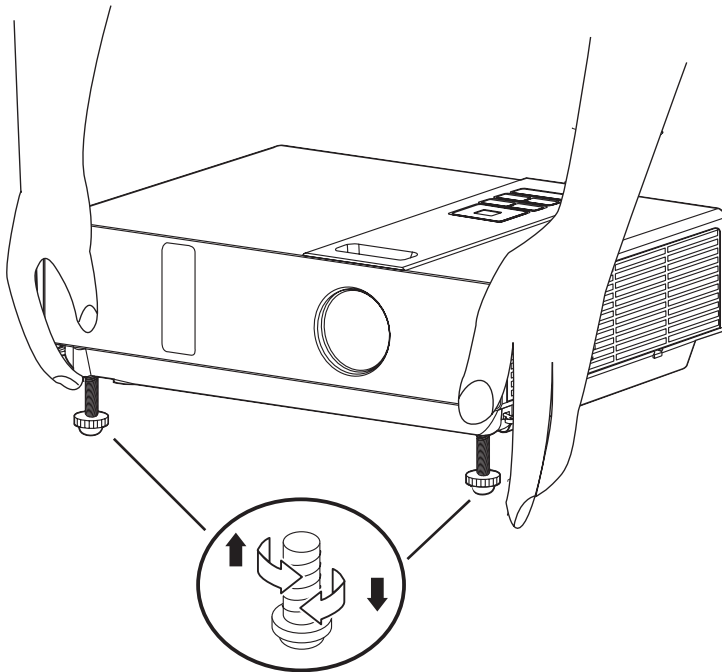

Setting Up

How To Connect

Laptop or desktop computer

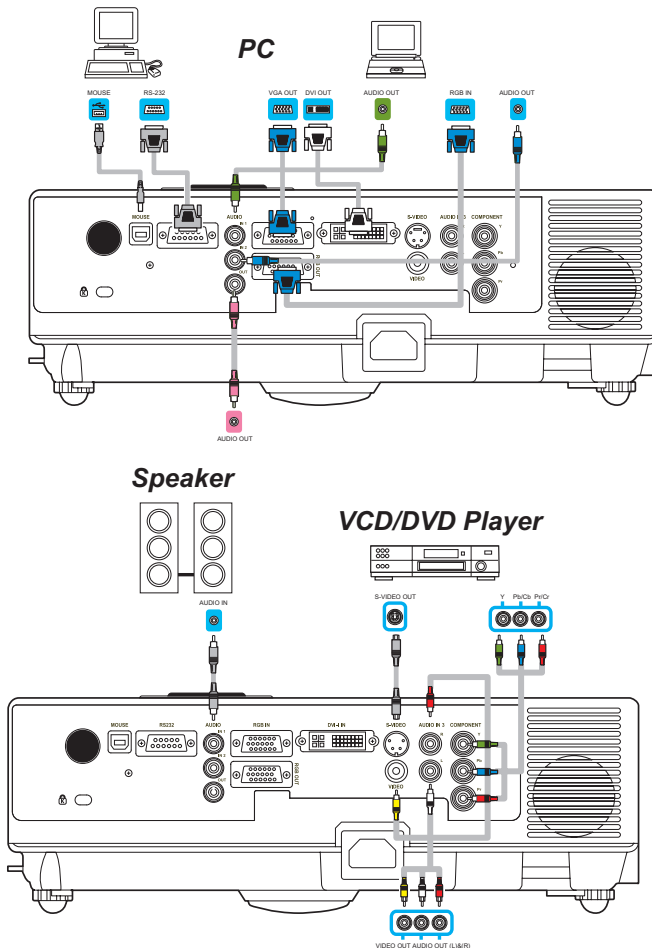

Before starting, make sure that the projector and computer are both turned off.

Connect the computer cable.

Connect either end of the computer cable to the projector's RGB IN.

Connect the computer cable from the computer to the projector.

If needed, connect the MONITOR OUT to a monitor to view input from RGB IN.

Tighten the screw on all connectors.

How To Connect

Laptop or desktop computer

Connect the audio cable if necessary

1. If you connect end of the computer cable to the projector's RGB IN. Please connect one other end of the audio cable to the AUDIO IN 1.
2. If you connect the DVI cable to the projector's DVI-I IN. Please connect one other end of the audio cable to the AUDIO IN 2.
3. If you connect the S-Video/ Video/ Y,Pb,Pr port of the projector. Please connect the other end of the audio cable to the AUDIO IN 3.

Connect USB Mouse

USB mouse compatible MS-Windows 98/ 2000/ NT/ XP/ Me, Macintosh : OS8.6~10.1, and a Microsoft Mouse driver installed.

1. Insert the end of the USB Cable (B-Type) to the projector's USB port.
2. Connect the end of the USB Cable (A-type) to the computer's USB port.
3. When the projector and computer are turned on, the appropriate drivers should load automatically.

☞ If the selected video image is not displayed after the projector is turned on and the correct video source has been selected, please check that the video source device is turned on and operating correctly. Also check that the signal cables have been connected correctly.

☞ Many laptops do not turn on their external video ports when connected to a projector. Usually a key combination like Fn + F3 or CRT/LCD key turns the external display on / off. Locate a function key labeled CRT/LCD or a function key with a monitor symbol on the laptop. Press Fn and the labeled function key simultaneously. Refer to your laptop's documentation to discover your laptop's key combination.

Remote Control Batteries Installation

1. Remove the battery cover.
2. Load the batteries.
Make sure the poles are correctly oriented.
3. Close the battery cover.

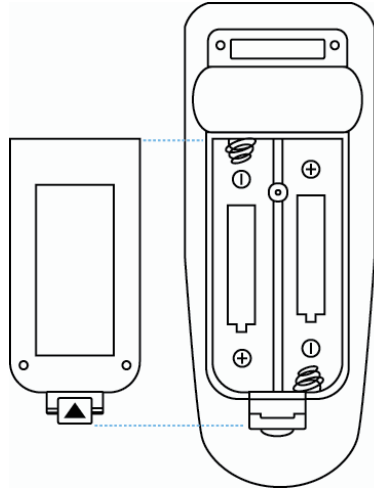

Caution

- ▶ Avoid excessive heat and humidity.
- ▶ Do not drop the remote control.
- ▶ If the remote control will not be used for an extended period, remove the batteries.
- ▶ Do not expose the remote control to water or moisture. This could result in malfunction.
- ▶ Replace the battery when remote control operation becomes sluggish or unresponsive.
- ▶ Do not place the remote control close to the cooling fan of the projector.
- ▶ Do not use batteries of different types at the same time.
- ▶ Do not mix a new battery with used one. Make sure the plus and terminals are correctly aligned when loading batteries.
- ▶ Dispose of batteries in accordance with environmental laws.
- ▶ Do not disassemble the remote control. If the remote control needs service, please contact your dealer.

Remote Control (Optional)

POWER

Power on / operation mode, Standby mode,
Cool down mode.

INPUT

Select input source :



MENU

Display or hide the On-Screen Display main
menu page.



Press  or  to select On-Screen
Display menu item.



Press  or  to select and adjust the
function of On-Screen Display menu item or
value.

LASER

Aim the remote control at the screen, press and
hold button to activate the laser pointer.

MUTE

Mute audio.

AUTO

Refresh the current image.

BLANK

Hide the current image, become black color on
the screen.

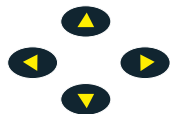

Press , , , or  button to move
arrow direction of window.

MOUSE-L / MOUSE-R

The function is like mouse of desktop/ notebook.

*Remote control's mouse functions only will
work if the USB cable is connected (see page 15
for instructions)*

ViewSonic

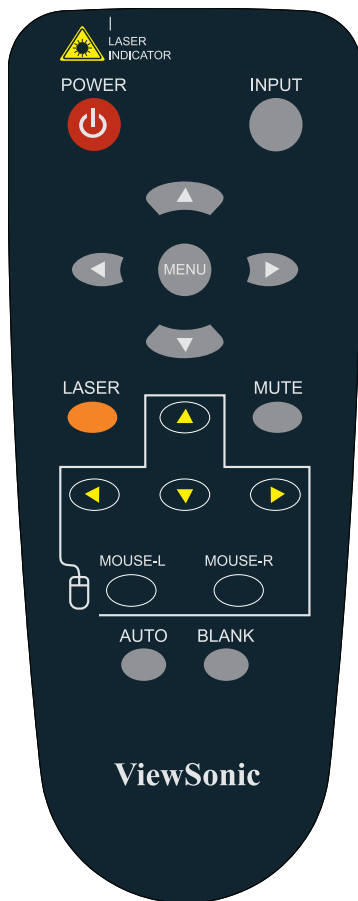

Menu Operation

How To Operate On-Screen Display

1. You could press "Menu" button. It will be shown blue main menu. The first main menu is " PICTURE" menu.
2. Choose which item you want to enter, you could press up / down /left/ right button of control panel or remote control to adjust item or value.

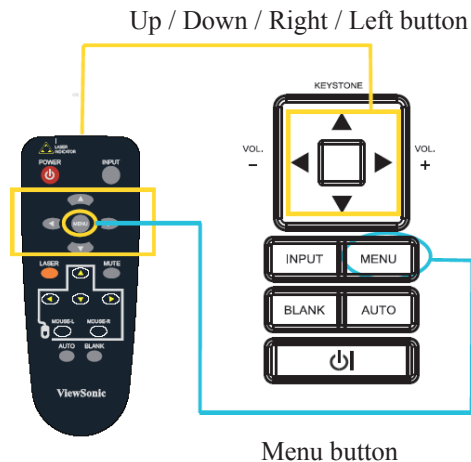
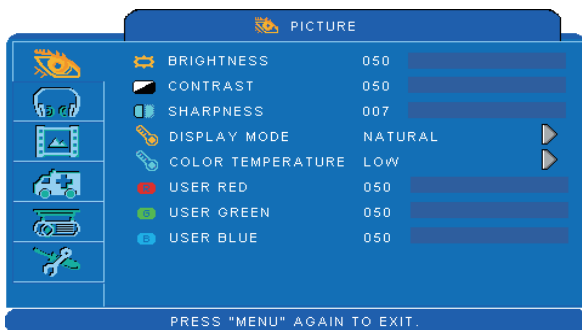

MENU (PC Mode)

Picture Menu



Step:

1. Use the ▲ / ▼ buttons to select an item.
2. Use the ◀ / ▶ cursor buttons to select an item or adjust the value.

| Item | Selection | Description |
|--------------|---|--|
| BRIGHTNESS | 000/100 | Adjust the image brightness level. |
| CONTRAST | 000/100 | Adjust the image contrast level. |
| SHARPNESS | 000/004 | Adjusts the image sharpness. |
| DISPLAY MODE | NATURAL | Nature color |
| | CINEMA | Enhance contrast mode for cinema mode |
| | DAYLIGHT | It to be suitable to the environment has strong light. |
| | GREEN BOARD WHITE BOARD BLACK BOARD | Adjust the color settings and makes the projected image on a (green, white, black) board more visible. |
| COLOR TEMP | LOW | Adjust the image color temperature level. |
| | MIDDLE | |
| | HIGH | |
| | USER | |
| | | User Red 000/100 |
| | | User Green 000/100 |
| | | User Blue 000/100 |

Audio Menu



Step:

1. Use the ▲ / ▼ buttons to select an item.
2. Use the ◀ / ▶ buttons to select an item or adjust the value.

| Item | Selection | Description |
|-----------------|---|---|
| VOLUME | 00/40 | Adjust the volume. |
| CHANNEL SETTING | RGB DVI-I Y,Pb,Pr VIDEO S-VIDEO | <pre> graph LR A1[Audio 1] --> A2[Audio 2] M[Mute] --> A3[Audio 3] A3 --> M </pre> |

MENU (PC Mode)

Image Menu



Step:

1. Use the ▲ / ▼ buttons to select an item.
2. Use the ◀ / ▶ buttons to select an item or adjust the value.

| Item | Selection | Description |
|---------------|-----------|--|
| H POSITION | 000/100 | Move the image position horizontally. This function is only selected for computer signal. |
| V POSITION | 000/100 | Move the image position vertically. This function is only selected for computer signal. |
| PHASE | 000/100 | Adjust the image sharpness. |
| FREQUENCY | 000/200 | Set the horizontal scanning frequency. |
| AUTO KEYSTONE | OFF/ON | Correct keystone distortion in image automatically. |
| KEYSTONE V | -70/+70 | Correct vertical keystone distortion in image manually. |
| RESIZE | | 4:3, 16:9, Native |
| AUTO SYNC | EXECUTE | Set all of the above setting automatically. |
| AUTO SEARCH | OFF/ON | Search signal source manually or automatically. |

* DVI doesn't support H POSITION, V POSITION, PHASE, FREQUENCY and AUTO SYNC.

MENU (Video Mode)

Picture Menu



Step:

1. Use the ▲ / ▼ buttons to select an item.
2. Use the ◀ / ▶ cursor buttons to select an item or adjust the value.

| Item | Selection | Description |
|--------------|---|--|
| BRIGHTNESS | 000/100 | Adjust the image brightness level. |
| CONTRAST | 000/100 | Adjust the image contrast level. |
| SHARPNESS | 000/004 | Adjusts the image sharpness. |
| COLOR | 000/100 | Adjust the strength of whole color. This function is for video signal, S-Video signal, or component video signal. |
| TINT | 000/100 | Adjust the image tint. This function is for video signal, S-Video signal, or component video signal. |
| DISPLAY MODE | NATURAL | Natural color. |
| | CINEMA | Enhance contrast mode for cinema mode |
| | DAYLIGHT | It to be suitable to the environment has strong light. |
| | GREEN BOARD WHITE BOARD BLACK BOARD | Adjust the color settings and makes the projected image on a (green, white, black) board more visible. |
| COLOR TEMP | LOW MIDDLE HIGH | Adjust the image color temperature level. |
| | USER | |
| | | User Red 000/100 User Green 000/100 User Blue 000/100 |
| | | |

MENU (Video Mode)

Audio Menu

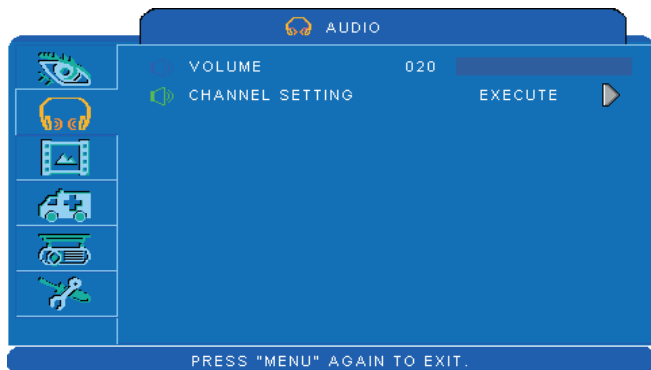

Step:

1. Use the ▲ / ▼ buttons to select an item.
2. Use the ◀ / ▶ buttons to select an item or adjust the value.

| Item | Selection | Description |
|-----------------|---|---|
| VOLUME | 00/40 | Adjust the volume. |
| CHANNEL SETTING | RGB DVI-I Y,Pb,Pr VIDEO S-VIDEO | <pre> graph LR A1[Audio 1] --> A2[Audio 2] M[Mute] --> A3[Audio 3] </pre> |

MENU (Video Mode)

Image Menu

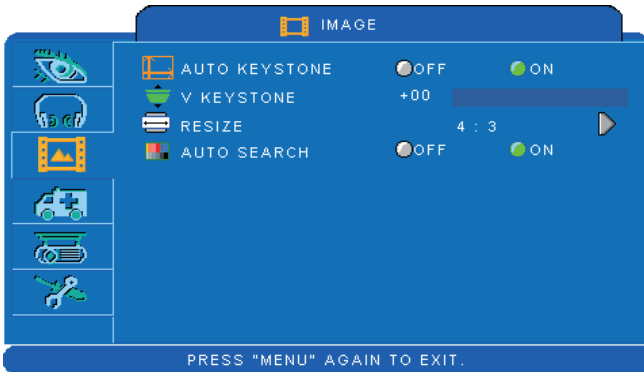

Step:

1. Use the ▲ / ▼ buttons to select an item.
2. Use the ◀ / ▶ buttons to select an item or adjust the value.

| Item | Selection | Description |
|---------------|-----------|---|
| AUTO KEYSTONE | OFF/ON | Automatically Correct keystone distortion in image. |
| KEYSTONE V | -70/+70 | Correct vertical keystone distortion in image manually. |
| RESIZE | | 4:3, 16:9 |
| AUTO SEARCH | OFF/ON | Search signal source manually or automatically. |

Setting Menu



Step:

1. Use the ▲ / ▼ buttons to select an item.
2. Use the ◀ / ▶ buttons to select an item or adjust the value.

| Item | Selection | Description |
|-----------------------------|-----------------------------------|--|
| LANGUAGE | ENGLISH | Select the language that the menu and on screen message is display in English → 繁體中文 → 简体中文 → 日本語 Deutsch ← Français ← Nederlands ← 한국어 Italiano → Polski → Português → Русский ไทย ← Українська ← Svenska ← Español |
| SELECT SOURCE | EXECUTE | Select the input source from: The search is started from the current port. Then when an input is found, the projector will stop searching and display the image. RGB → DVI-I S-Video ← Video ← Y,Pb,Pr |
| LOGO SETTING | EXECUTE | Customize the start-up logo. |
| LAMP MODE | NORMAL / ECONOMIC | Economic mode reduces the lamp brightness. |
| LAMP | | Show lamp use time. |
| RESET LAMP TIMER (optional) | EXECUTE | After changing a new lamp, execute this option to reset the lamp timer. |
| FILTER TIMER | | Show the filter use hour. |
| RESET FILTER TIMER | EXECUTE | Reset the filter timer after cleaning or change filter. |
| FILTER COUNTER | 500 HOUR 800 HOUR 1000 HOUR | Select (500 / 800 / 1000 hours) depending on the environment.(default : 500 hours). Please see as below. |

Setting Menu

Reset Lamp Timer

The lamp timer is the time counted after the last resetting. The usage time of the lamp is shown in the PRESENTATION Menu. Pressing the RESET button or the ► button displays a dialog.

To reset the lamp time, select the RESET using the ► button.

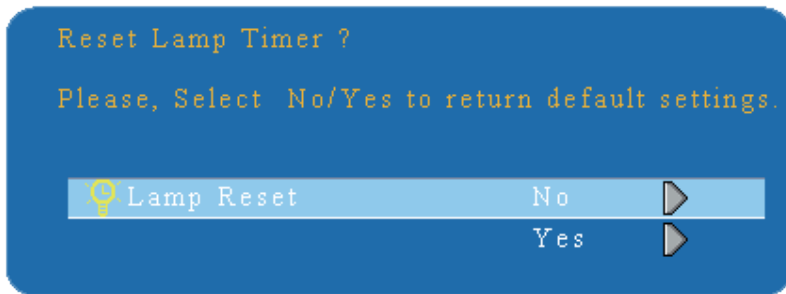

NOTE

- The replacement warning message is set to appear after about 2000 hours of lamp use in order to maintain the initial bright replacement message appears, replace the lamp with a new one as soon as possible, even if it is still working.

Setting Menu

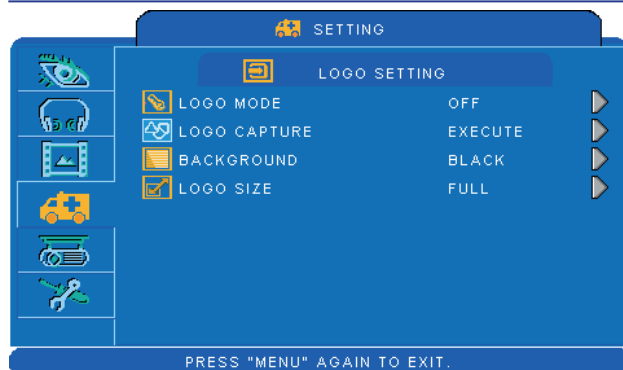

LOGO SETTING

This function allows you to customize the start-up logo.

IMPORTANT:

To execute the logo function, you must enter the PIN code first.

| Item | Selection | Description |
|--------------|------------------------|--|
| LOGO MODE | DEFAULT USER OFF | Select Mode(► cursor button) |
| | | The factory logo. |
| | | The image you captured. The blank image. You can select color with background function. |
| LOGO CAPTURE | EXECUTE | Start to capture the image.(PC mode only) |
| BACKGROUND | BLACK BLUE WHITE | Set background color. |
| LOGO SIZE | ORIGINAL FULL | Display the captured image in original size and put in the center of the screen. Expend the image to full screen. |

Setting Menu

Logo Capture

How to use this function?

- ❶ Select Logo Capture item in the logo setting menu, and press ► button.
- ❷ You can see the red frame to select captured area.
- ❸ Use 4 direction buttons to adjust the position of the frame.
- ❹ Press “MENU” to start capturing and display a dialog.

❷

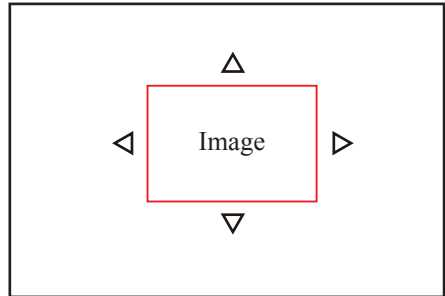

❹

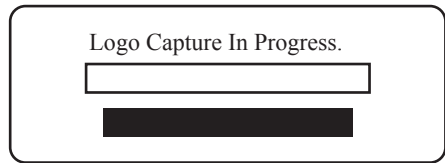

- NOTE** ► To capture an image is available only in computer mode.
 ► The area that can be captured is 512 x 384 dots.

Option Menu

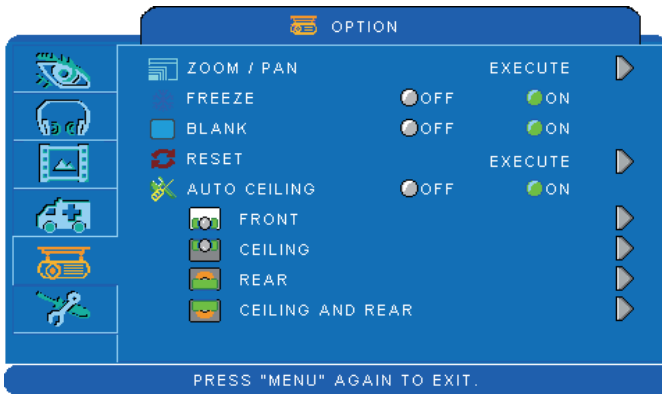

Step:

1. Use the ▲ / ▼ buttons to select an item.
2. Use the ◀ / ▶ buttons to select an item or adjust the value.

| Item | Selection | Description |
|------------------|-----------|---|
| ZOOM / PAN | EXECUTE | Execute digital and pan function. |
| FREEZE | OFF / ON | Freeze the current image on the screen. |
| BLANK | OFF / ON | Hide the image, display a black screen. |
| RESET | EXECUTE | Reset all menu function to their factory default values. |
| AUTO CEILING | OFF / ON | Automatically invert the image when the projector is turned upside down, i.e. when the projector is mounted on the ceiling. |
| FRONT | EXECUTE | Normal projection mode. |
| CEILING | EXECUTE | Mirror the image vertically, only for the projector mounted upside down. |
| REAR | EXECUTE | Mirror the image horizontally, only for projecting onto rear projection screen. |
| CEILING AND REAR | EXECUTE | Mirror the image horizontally and vertically. Projecting onto a rear projection screen while projector is upside down. |

Advanced Menu



Step:

1. Use the ▲ / ▼ buttons to select an item.
2. Use the ◀ / ▶ buttons to select an item or adjust the value.

| Item | Selection | Description |
|----------------|--|--|
| SECURITY | EXECUTE | You could execute PIN LOCK PROTECTION and MODIFY PIN functions. |
| DCR | OFF / ON | DCR (Dynamic Contrast Ratio) to strengthen image contrast strongly. If DCR is turned on, the projector will automatically switch the lamp mode between normal or ECO mode according to the input image level decided. ⚠ After enabling DCR, frequent lamp mode switching may shorten lamp life and noise level will vary during operation. |
| CLOSED CAPTION | OFF(Default) C.C1 C.C2 C.C3 C.C4 T1 T2 T3 T4 | The Closed Caption function intimates the sound effects, dialogue, and narration in the content of the television program or video source. Caption (C.C1~C.C4) : Display closed caption Text (T1~T4) : Display text data, which is for additional information such as news reports or a TV program guide. NOTE: This function is available only in video / S-Video source. |
| BLANK OFF | 15 MINUTES 30 MINUTES 60 MINUTES | Choose when image is blank off. |
| NO SIGNAL OFF | 15 MINUTES 30 MINUTES 60 MINUTES | Turn off when no signal is received. |
| AUTO ON | OFF / ON | Turn on lamp automatically. |

Advanced Menu

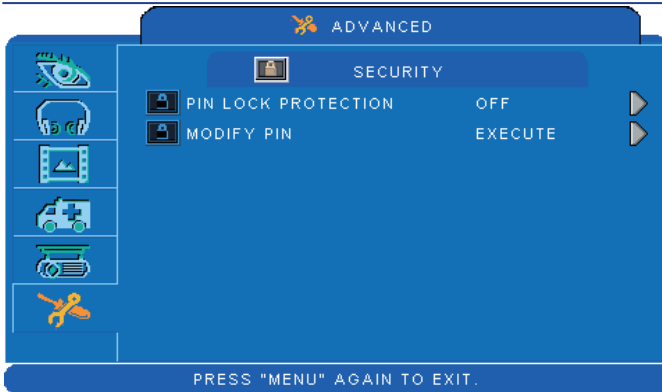

Step:

1. Use the ▲ / ▼ buttons to select an item.
2. Use the ◀ / ▶ buttons to select an item or adjust the value.

| Item | Selection | Description |
|---------------------|---------------------|---|
| PIN LOCK PROTECTION | OFF ON 1 ON 2 | <p>OFF: Turn off PIN lock protection. ON 1: PIN code is needed only in the first time after AC power has been switched off. ON 2: PIN code is needed every time while the projector is turned on.</p> <div style="border: 1px solid black; padding: 5px;"> <p>⚠ CAUTION: Once the PIN code had been set, the projector cannot be used unless you enter the correct PIN code.</p> </div> |
| MODIFY PIN | EXECUTE | <ol style="list-style-type: none"> 1. Press “ MENU ” on the projector or remote control. 2. Use the ▶ button to select the MODIFY PIN item of the SECURITY category. 3. Press the ▶ button to change PIN LOCK PROTECTION mode. 4. Please enter the original PIN code. <ol style="list-style-type: none"> (a) If the PIN is correct, system will allow you to change a new PIN code. (b) If the PIN is incorrect, a “ Code Error ” message will appear. 5. Please enter a new PIN code. And then enter again to confirm. <div style="border: 1px solid black; padding: 5px;"> <p>NOTE:</p> <ol style="list-style-type: none"> (1) To change the PIN lock protection state, you must enter the PIN code first. (2) Please enter: 0000 for first-time use. (3) Write your selected password down here in this manual to help you remember it; see the selection “Appendix”. (4) To avoid unnecessary trouble, if you activate the [PIN Lock Protection], it is highly recommended that you write down the PIN code and store it in a safe place. </div> |

PIN Key In Operation

When the projector is turned on and the PIN LOCK PROTECTION is set to [ON], the image will show as on the right side.

1. Press the MENU button on the projector or remote control. Enter PIN code by keypad or remote control.
2. How to enter a PIN code?
You can use control panel or remote control.

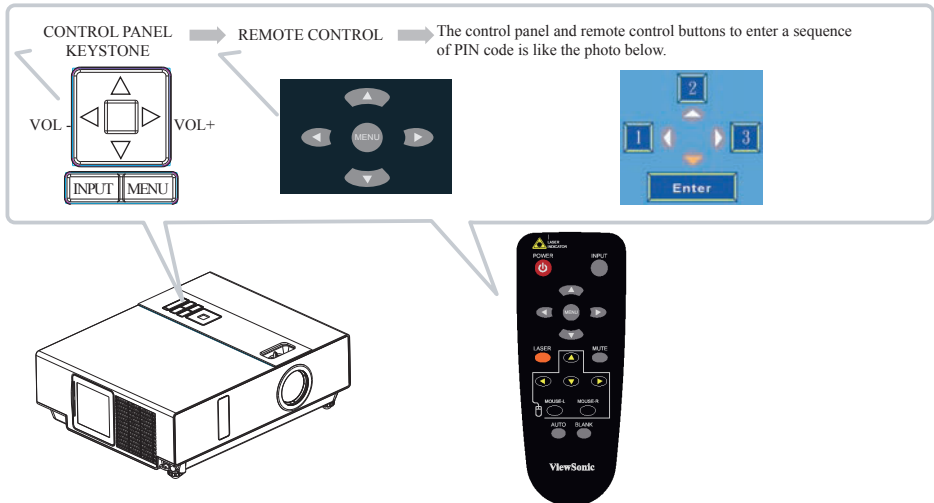
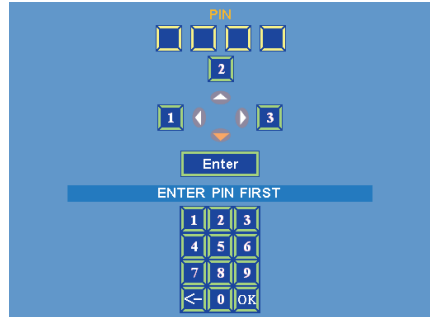

- (1) Press ◀ button: Select the [1]
- (2) Press ▲ button: Select the [2]
- (3) Press ▶ button: Select the [3]
- (4) Press ▼ button: Select the [Enter] move to next row.(4~6,7~9, ~OK)
- (5) Press (backspace) item:
In case you enter a wrong digit, select to delete the wrong digit you entered.
- (6) Press (backspace) item:
Once all four digits of the PIN are entered, select to confirm.

NOTE

If the PIN is incorrect, a ‘ Enter new code ’ message will be shown. Please try again. If the PIN code input is incorrect for three times, a warning message will show up and the projector will shut itself down in 30 seconds.
If you have no idea about the PIN, please contact your dealer for help.

Network Control Software Application

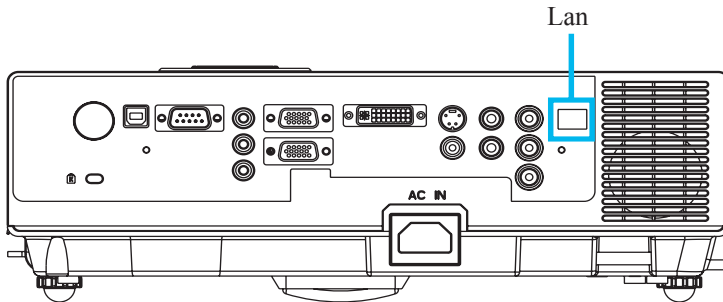

NOTE: This Network Control Software Application is an optional function and support model with RJ45 LAN port only.

- ❶ Register the projector(s) which needs to be controlled.
“ Auto search ” can help you to seek the projector(s) source easily.
After registering in the work group, you can start to control the projector.
- ❷ Group the projector(s) into different sections.
You can monitor the status easily by the sort of group name function in the network.
- ❸ Monitor the status for each projector.
 - a. You can manage and change the monitoring content by System Parameter Setting.
 - b. The Lamp timer, filter working time or system warning feedback etc. can be known by checking the status for projector(s).
- ❹ Control the booked projector(s).
The status can be refreshed and acquired by monitoring functions; you can also operate the function easily by Network Control.

NOTE

To monitor and control the projector(including stand-by mode), the following conditions need to be ready:

- (1) Projector should already be powered on.
- (2) Projector is connected to network.
- (3) LED light of the projector network port shows normal. (Green light on, Orange twinkle)

* Stand-by mode indicator: Green LED (Power) on the projector’s control panel flashes.

Before Use

Before To Use Network Control Software

- 1 If the system is Windows 2000, NT 4.0 or XP, the PC should be started by the Administrator.
- 2 Before starting the Network Control software, please check the following.
 - (1) The computer must have Network Control software installed.
 - (2) The projector should be powered on and the LAN wire is well connected to projector.
 - (3) Make sure the computer and projector can connect to network. Network Control software needs to arrange in TCP/IP network communication and the network cable.

Open Network Control Software

- 1 Click Network control software icon.



- 2 Monitor window will show as Graph 1 and Table 2.

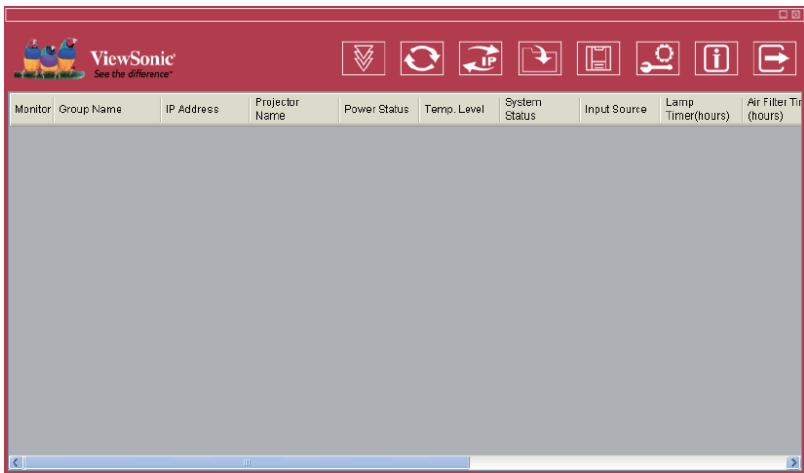

<Graph 1>

Before Use

Projector Auto Search.

- 1 Click the  (Projector search), located projector will show on the network correctly. (Graph2)

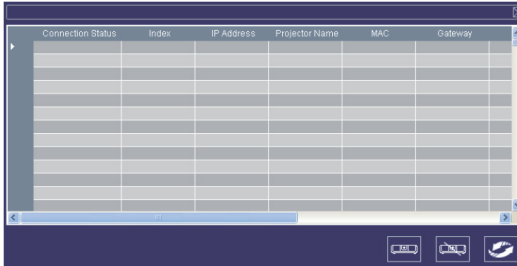

<Graph 2>



NOTE

When the security warning window appears while Network Control is executing, please select "Unblock" to decontrol area network linking against from System Administer.

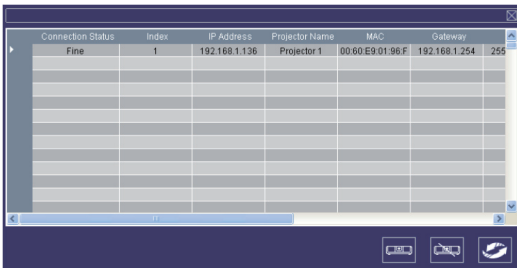
- 2 Click  (search again), the projector which is well connected with a PC will be shown. (Graph3)



<Graph 3>

- 3 Click  (register projector), the projector information will show on the monitor window. Click  button (exit), it will cancel the registered item then return to register table.

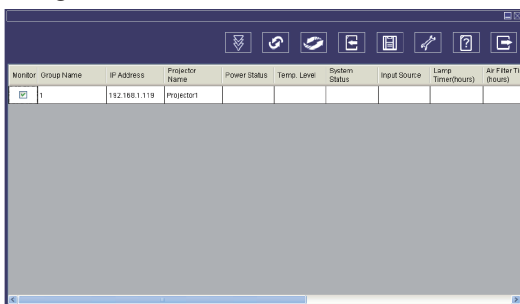

<Graph 4-1> Monitor window

Before Use

Projector Auto Search.

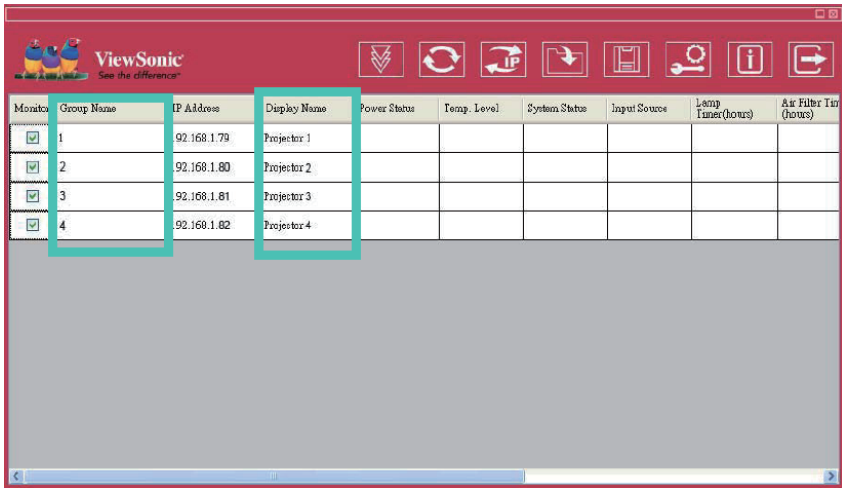

- 4 Projector Auto Search can rank group names or display names by clicking the monitor window title (Group Name) or (Host Name). This will help you easily to understand projectors status.



The screenshot shows the ViewSonic software interface with a table of projector information. The table has the following columns: Monitor, Group Name, IP Address, Display Name, Power Status, Temp. Level, System Status, Input Source, Lamp Timer (hours), and Air Filter Tar (hours). The first four columns are highlighted with a red box. The data in the table is as follows:

| Monitor | Group Name | IP Address | Display Name | Power Status | Temp. Level | System Status | Input Source | Lamp Timer (hours) | Air Filter Tar (hours) |
|-------------------------------------|------------|-------------|--------------|--------------|-------------|---------------|--------------|--------------------|------------------------|
| <input checked="" type="checkbox"/> | 1 | 92.168.1.79 | Projector 1 | | | | | | |
| <input checked="" type="checkbox"/> | 2 | 92.168.1.80 | Projector 2 | | | | | | |
| <input checked="" type="checkbox"/> | 3 | 92.168.1.81 | Projector 3 | | | | | | |
| <input checked="" type="checkbox"/> | 4 | 92.168.1.82 | Projector 4 | | | | | | |

<Graph 4-2>

- 5 After registering, you can click  button (Data single capture) in the tool bar or click  button (Start Auto Scan) running in this program to monitor the projector.

NOTE

When pressing “About ” button for help, you will see icons explained as in the chart below.

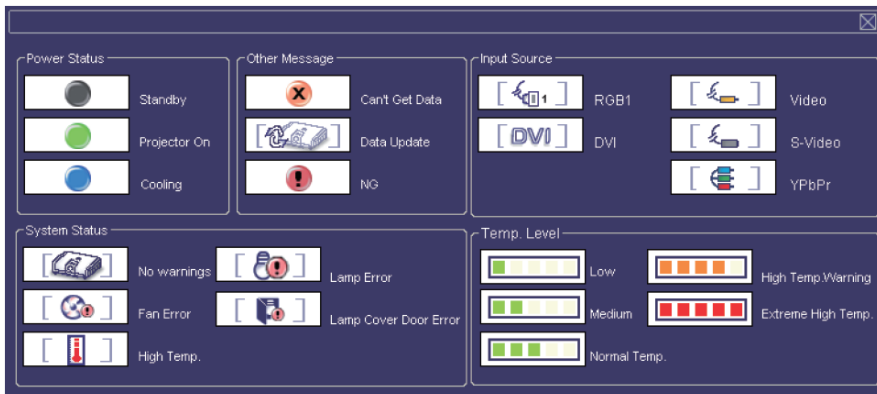

Before Use

Modify The Projector Setting

- 1 If modifying the registered projector setting is needed, please move your cursor to the data table and click the item that you would like to modify, the detail will be shown on the right side table.

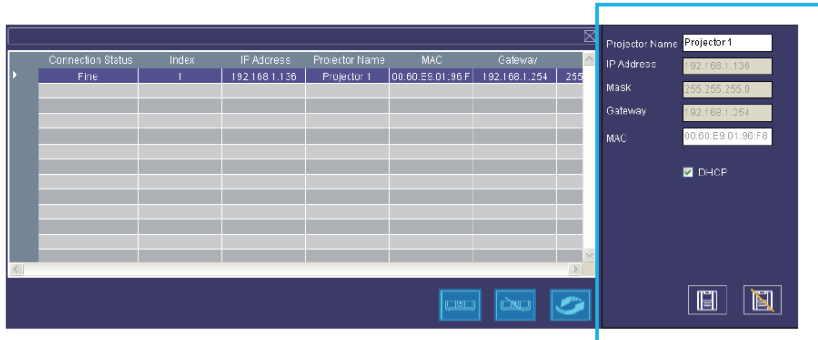

< Graph 5 > : Register Table.

- 2 After setting, you can save the data by clicking  button or cancel by clicking  button.

| Item | Description |
|--------------|--|
| Display name | Show the Host name (16 characters at most in ASCII) |
| IP Address | Show the IP Address |
| Mask | Show the Mask |
| Gateway | Show the Gateway |
| MAC | Show up the MAC code (The default value can not be modified) |
| Monitor | Show up the projector monitor status (The default set in power on status) |
| DHCP | Capture IP address from network sensor automatically. |

< Table 3 > : Setting Windows

Registering And Configuring The Projector

Delete

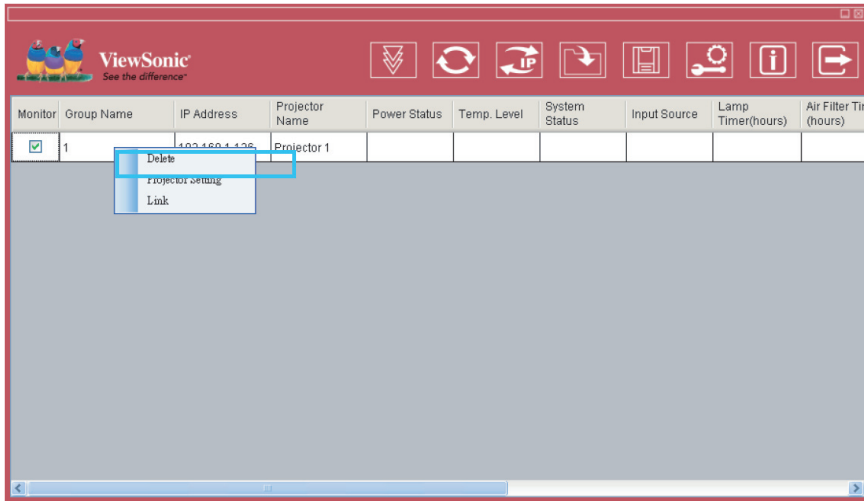

- 1 Select the registered projector in monitor window. Click mouse right key and select “Delete ” to erase the registered projector data.



< Graph 6 > : Register Table.

Registering And Configuring The Projector

Projector Setting

- 1 Select the registered projector in monitor window. Click mouse right key and select “projector setting” to modify the registered projector data. After finishing the setting, you can save by clicking  button or cancel by clicking  button.

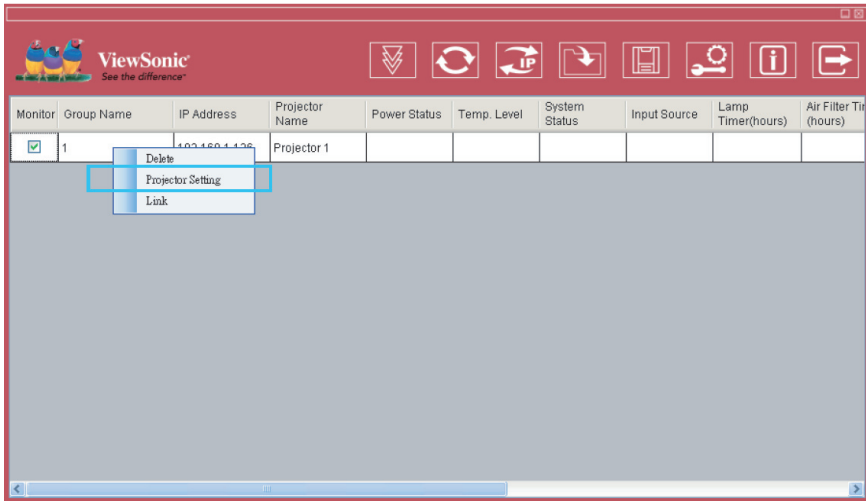

< Graph 7 > : Register table.

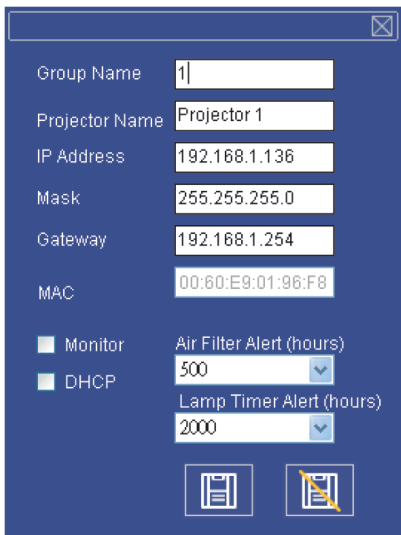

< Graph 8 > :Setting table.

Registering And Configuring The Projector

Projector Setting

- 2 Click  button (system setting) to modify system alert setting.

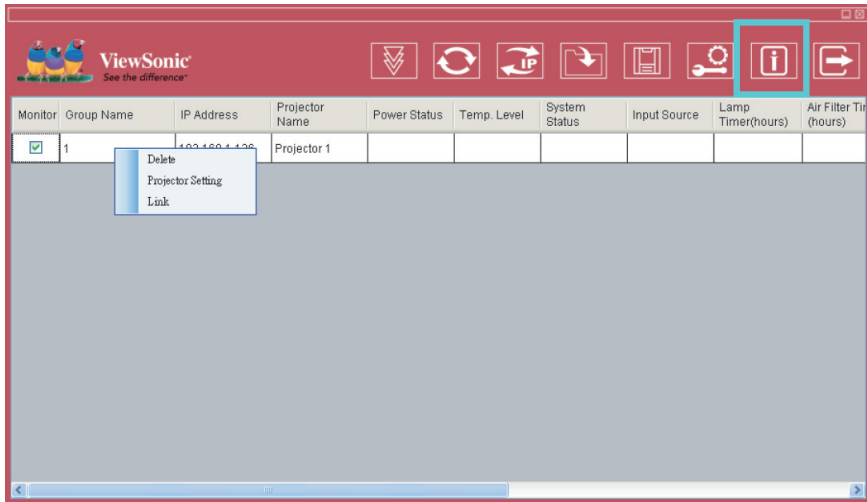

< Graph 9 >

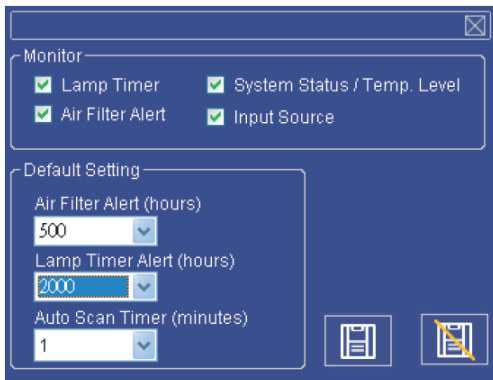

<Graph 10> :Setting table.

Registering And Configuring The Projector

System Setting

Monitor

| Item | Description |
|-----------------------------------|---|
| Lamp Timer | Lamp timer from projector. |
| Air Filter Alert | Air Filter Timer from projector. |
| System Status/ Tempeture Level | System Status and Tempeture. Level from projector in Power On status. |
| Input Source | Input Source from projector in Power ON status. |

< Table 4 >

Default Setting

| Item | Description |
|-----------------------------|--|
| Lamp Timer Alert (Hr.) | Default Setting Includes 1000/1500/2000 Hours. When Lamp Timer reach alert target, window will show lamp timer in red color to remind user to replace the lamp. |
| Filter Timer Alert (Hr.) | Default setting includes 300/500/800/1000/1500 Hours. When Filter Timer reach alert target, window will show filter timer in red color to remind user to replace the filter. |
| Auto Detect Timer (minutes) | Auto Detect setting. Default setting includes 1/3/5/10 minutes; user can set the optimal default listed in Table 6. |

< Table 5 >

Auto Detect Optimal Setting

| Projector Number (Sets) | Timer Interval (Minutes) |
|-------------------------|--------------------------|
| 1~25 | 1/3/5/10 |
| 26~50 | 3/5/10 |
| 51~100 | 5/10 |
| 101~255 | 10> |

* The maximum quantity of projector monitored is 255.

< Table 6 >

Registering And Configuring The Projector

Link

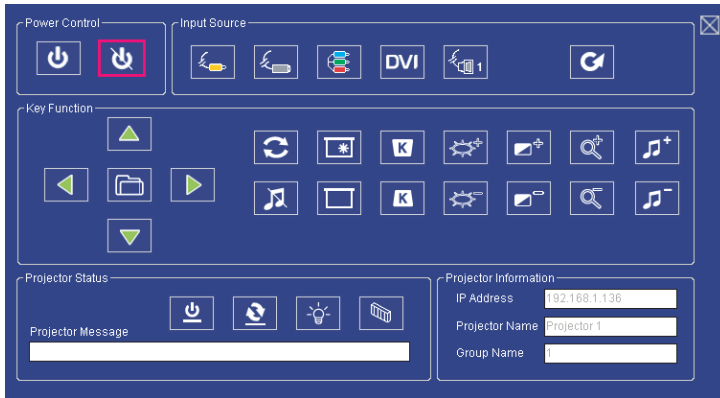

- 3 Select the registered projector in monitor window. Click mouse right key and select “ Link ” to show up the control panel table and the projector connected status.









< Graph 12 > : The control panel table

Control Panel Window Introduction















① Power Control

| Icon | Name |
|---|-----------|
|  | Power on |
|  | Power off |

② Input Source





| Icon | Name |
|---|---------------------|
|  | Video |
|  | S-Video |
|  | Y,Pb,Pr |
|  | DVI-I |
|  | RGB 1 |
|  | Change Input Source |

③ Function Key





| Icon | Name | Icon | Name |
|---|-----------|---|-----------------------|
|  | Up |  | Freeze |
|  | Down |  | Blank |
|  | Left |  | Keystone Correction + |
|  | Right |  | Keystone Correction - |
|  | Menu |  | Increase Brightness |
|  | Auto Sync |  | Decrease Brightness |
|  | Mute |  | Higher Contrast |

Control Panel Window Introduction

3 Function Key









| Icon | Name |
|---|----------------|
|  | Lower Contrast |
|  | Zoom In |
|  | Zoom Out |
|  | Volume Up |
|  | Volume Down |

4 Projector Status

| Icon | Name |
|---|---------------------|
|  | System Status |
|  | Input Source Status |
|  | Lamp Timer |
|  | Air Filter Timer |

Control Panel Window Introduction

1 Network Control Window introduction

| Icon | Name | Description |
|---|-------------------|---|
|  | Scan all | Capture the projector information 1 time only. |
|  | Start Auto Scan | According to the system setting, get the projector information automatically. |
|  | Stop Auto Capture | |
|  | Auto Search | Search the projector in the same network to register and modify the setting. |
|  | Open Project File | Open project file which was saved. |
|  | Save Project File | Save the registered projector in this project. |
|  | System Setting | Setting the projector system remind message. |
|  | About | Icon content description. |
|  | Exit | Exit the Network software. |

Air Filter

When a warning message appears to remind you to clean the air filter, please replace a new one as soon as possible. Please check and clean the air filter periodically.

Replacing the Air Filter

When the use time reaches the filter counter time, the projector will display a message that indicates to replace a new filter. If there is no spare air filter available, please contact your dealer.

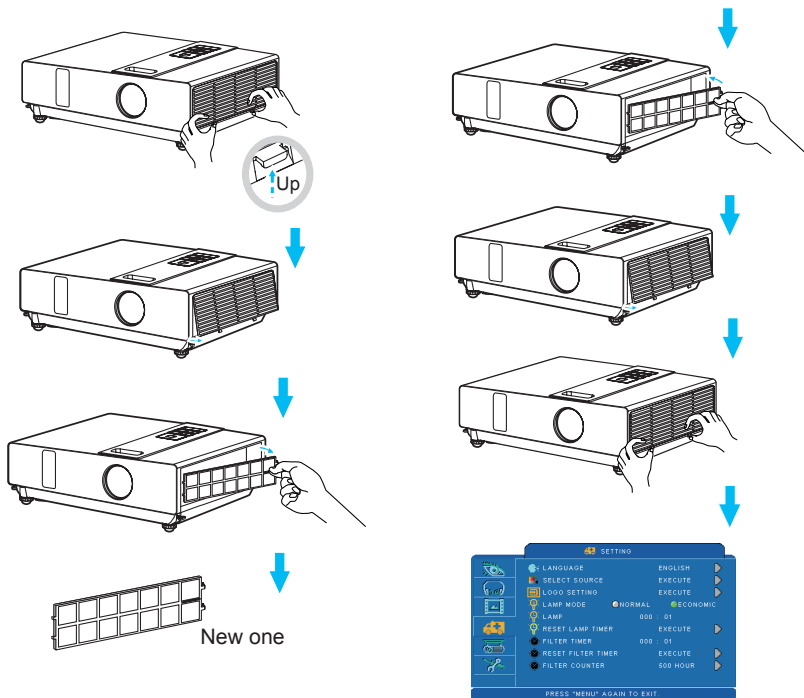

Turn off the projector, and unplug the power cord. Allow the projector to sufficiently cool down.

- 1 Remove the filter cover from the right side of projector.
- 2 Pull out the air filter.
- 3 Install a new air filter.
- 4 Put the filter cover on.
- 5 Reset filter timer after cleaning or changing air filter. (P.25)

Lamp

1. If you want to replace new lamp, but the projector was just turned off, please let the projector cool down and unplug power cord at least 60 minutes.
2. If the projector is mounted in the ceiling, contact your dealer to replace the lamp.

Replacing New Lamp

1. Remove the lamp door.
2. Loosen 2 screws of the lamp holder. Take the handle on the top of the lamp, pull out the lamp straight off the projector.
3. Insert new lamp, lock the lamp door firmly with 2 screws.
4. Put the lamp door on.
5. Please reset the lamp timer after replacing lamp. (P.26)

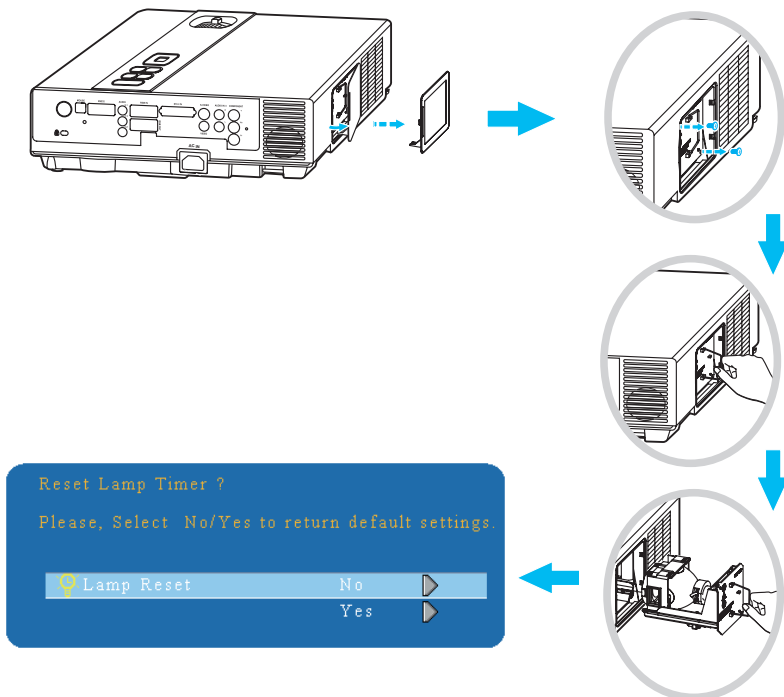

Other Care

Cleaning The Lens

If the lens is dirty and dusty, display quality maybe decreased. Before cleaning the lens, please make sure that the projector is cool down adequately.

After the projector has cooled down adequately, lightly wipe the lens with the available lens-cleaning cloth.

Do not touch the lens directly with your hand.

Additional

-In order to ensure the safe use of your projector, please contact your dealer to inspect about once a year.

-Before maintenance, make sure the power cable is unplugged, allow the projector to cool sufficiently. The high temperature state of the projector could cause a burn in and/or malfunction to the projector.

-Never try to maintain the inside of the projector by yourself

-Avoid wetting the projector or inserting liquids in the projector. This could result in a fire, an electric shock, and/or malfunction to the projector.

Troubleshooting

Indicator

The power and lamp indicators show the status of the projector. Before requesting repair, check the projector status using the chart below. If the problem cannot be resolved, contact your dealer.

In normal status~~~

| POWER | LAMP | CONDITIONS | DESCRIPTION |
|--------------------------|------------------------------------|----------------|--|
| Blinking In Green | Off | Stand by mode | Projector is ready to be turned on. |
| Lighting In Green | Off | On mode | Projector is on and operating. |
| Lighting In Green | Blinking In Red (Slow) | Cool down mode | Projector is in cool down mode and will not respond to user input. |

In abnormal status~~~

| POWER | LAMP | CONDITIONS | DESCRIPTION |
|---------------------------------|------------------------------------|------------------|---|
| Blinking In Green | Blinking In Red (Fast) | Fan fault mode | The projector has detected a problem of a slow internal fan speed. The lamp will shut off automatically. Contact your dealer. |
| Blinking In Green | Lighting In Red | Lamp cover open | The lamp cover is open or there is a problem with the lamp. If the lamp door is closed and replacing the lamp does not correct the issue, contact your dealer. |
| Blinking In Green (Fast) | Blinking In Red (Fast) | High temperature | The projector has overheated and shut itself down. Correct the over temperature condition immediately. 1. Check that the ventilation slots are free from obstructions. 2. Check the cleanliness of the air filter. |
| Blinking In Green (Slow) | Blinking In Red (Slow) | Lamp fail | The lamp does not light. Come back to “ stand by mode ”, and press the power button. |

Troubleshooting

Error For Machine Defects

The following problems may be confused with a machine defect. Check and follow the table. If it couldn't be improved, contact your dealer.

| Symptom | Cause / Remedy |
|-----------------------------------|--|
| Projector power does not turn on. | The power cord is disconnected. Plug the power cord into an AC outlet. |
| | Intending to turn on the projector again during the cool down mode. Wait until the cool down mode has completed. |
| | There is no lamp and/or lamp cover is not firmly closed. Please turn off the power and disconnect the power plug from the power outlet. Check if the lamp is installed or the lamp cover is firmly closed and turn on the power again. |
| | Power cord has impaired. When you touch the power cord, the indicator goes on then off, please remove the power cord and connect it again. If the situation is repeated, remove the power cord and contact your dealer. |
| No Video | The input is not connected correctly. Select the appropriate input source. |
| | No signal input. Connect correctly. |
| | The lens cover is attached to the lens. Remove the lens cover. |
| Colors are pale | Color density and color matching are not adjusted correctly. Adjust the RGB setting. |
| | Color lose. Caused by poor VGA cable connection. |
| Abnormal brightness & contrast | Brightness and contrast are not adjusted correctly. Adjust the brightness and contrast setting. |
| | The lamp is near the end of its service life. Replace with a new lamp. |
| Video is blurred | The projection lens is not focused. Adjust the focus using the focus ring. |
| | The lens is dirty or misty. Clean the lens. |

Troubleshooting

Error For Machine Defects

| Symptom | Cause / Remedy |
|--------------------------------|--|
| No audio | The projector is not connected correctly. Check audio cable if connect correctly. |
| | The volume is set to minimum. Adjust the volume. |
| | Mute is turned on. Press the MUTE button. |
| Remote control is not working. | No battery. Before using the remote control, please check the battery of remote control. |
| | Remote signal is obstructed. Remove the obstacle between projector and remote control. |

Troubleshooting

List of Supported Monitor Displays

| Computer mode | | |
|----------------------------|--------------------------|--------------------------|
| Signal | Refresh Rate (Hz) | Resolution (dots) |
| VGA | 60 | 640x480 |
| VESA | 60 /72 /75/85 | 640x480 |
| SVGA | 56 /60/72/75 /85 | 800x600 |
| XGA | 60 /70/75/85 | 1024x768 |
| SXGA | 70 /75 | 1152x864 |
| SXGA | 60 /75 | 1280x960 |
| SXGA | 60 | 1280x1024 |
| WXGA | 60 /75 | 1280x800 |
| WXGA+ | 60/75/85 | 1440x900 |
| SXGA + | 60/75 | 1400x1050 |
| UXGA | 60 | 1600x1200 |
| MAC | 67 | 1280x1024 / 640x480 |
| MAC | 75 | 832x624 |
| MAC | 75 | 1024x768 |
| MAC | 75 | 1152x870 |
| Component (Y,Pb,Pr) | | |
| Signal | Refresh Rate (Hz) | Resolution (dots) |
| SDTV(480i) | 30 | 720x480 |
| SDTV(480p) | 60 | 720x480 |
| HDTV(720p) | 60 | 1280x720 |
| HDTV(1080i) | 30 | 1920x1080 |
| Composite / S-Video | | |
| Signal | Refresh Rate (Hz) | Resolution (dots) |
| TV(NTSC) | 60 | 720x480 |
| TV(PAL,SECAM) | 50 | 720x576 |

Appendix

Menu Tree (PC Mode)

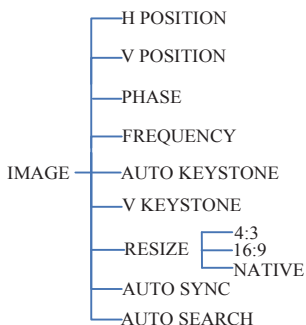
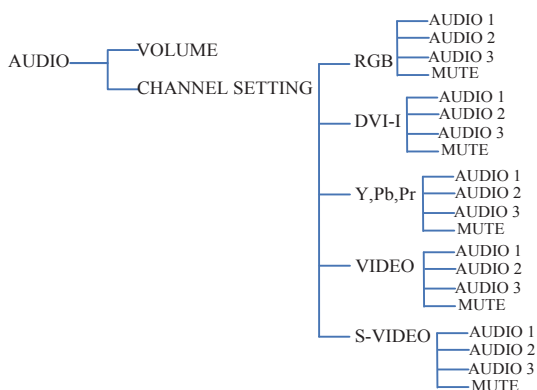
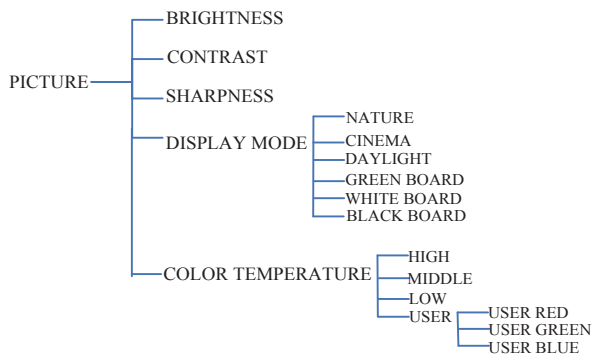

*DVI doesn't support H / V POSITION, PHASE, FREQUENCY, AUTO SYNC function.

Appendix

Menu Tree (PC Mode)

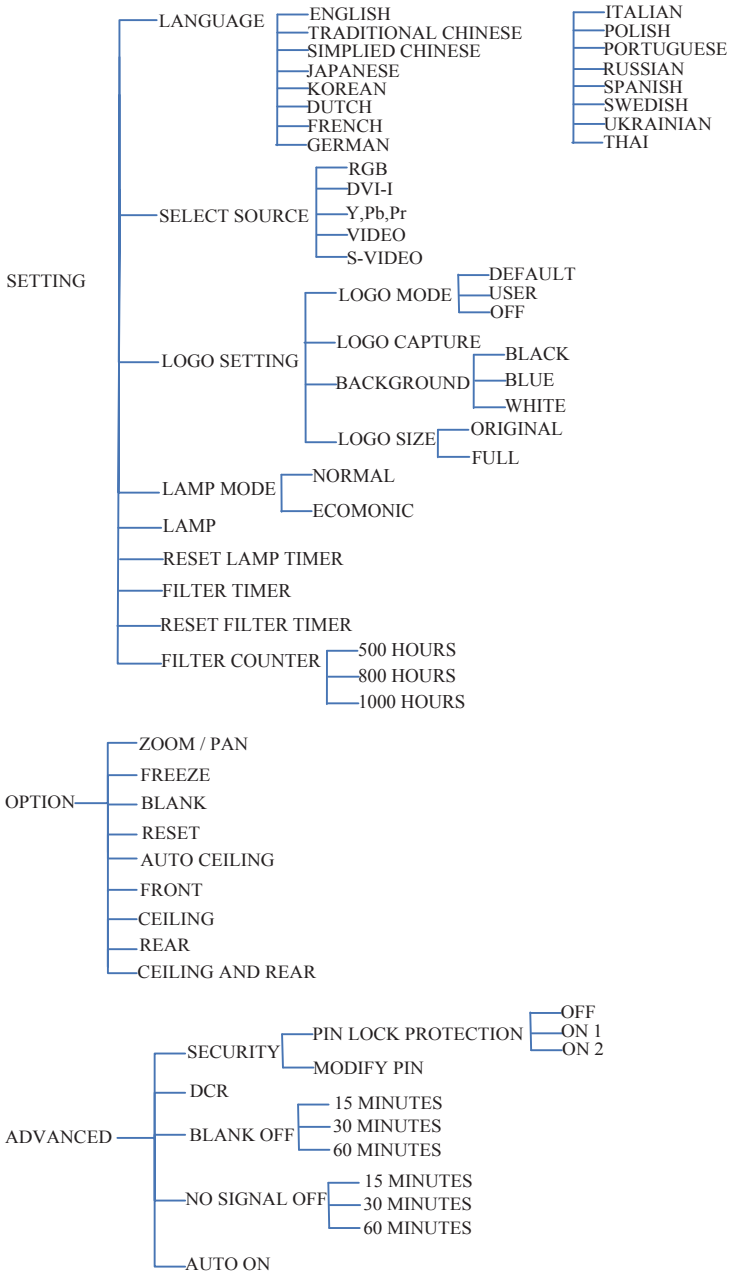

Appendix

Menu Tree (Video Mode)

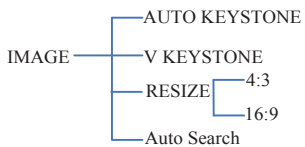
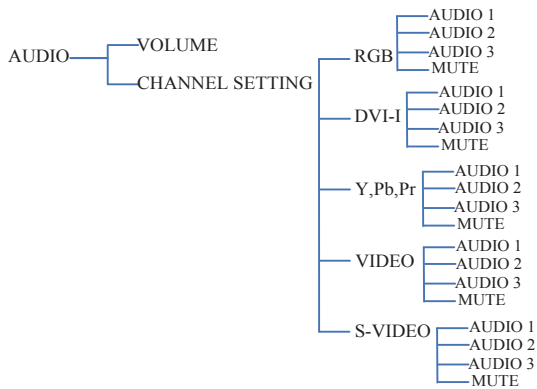
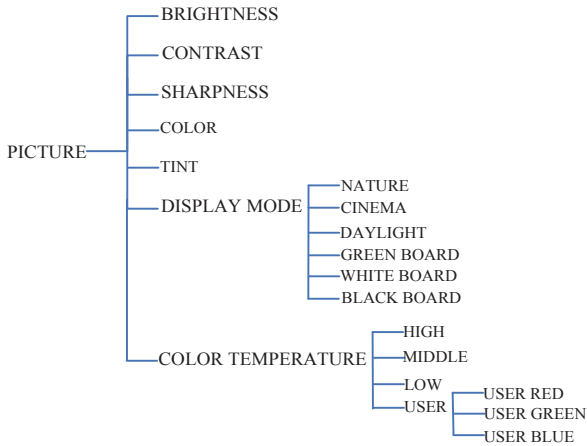

Appendix

Menu Tree (Video Mode)

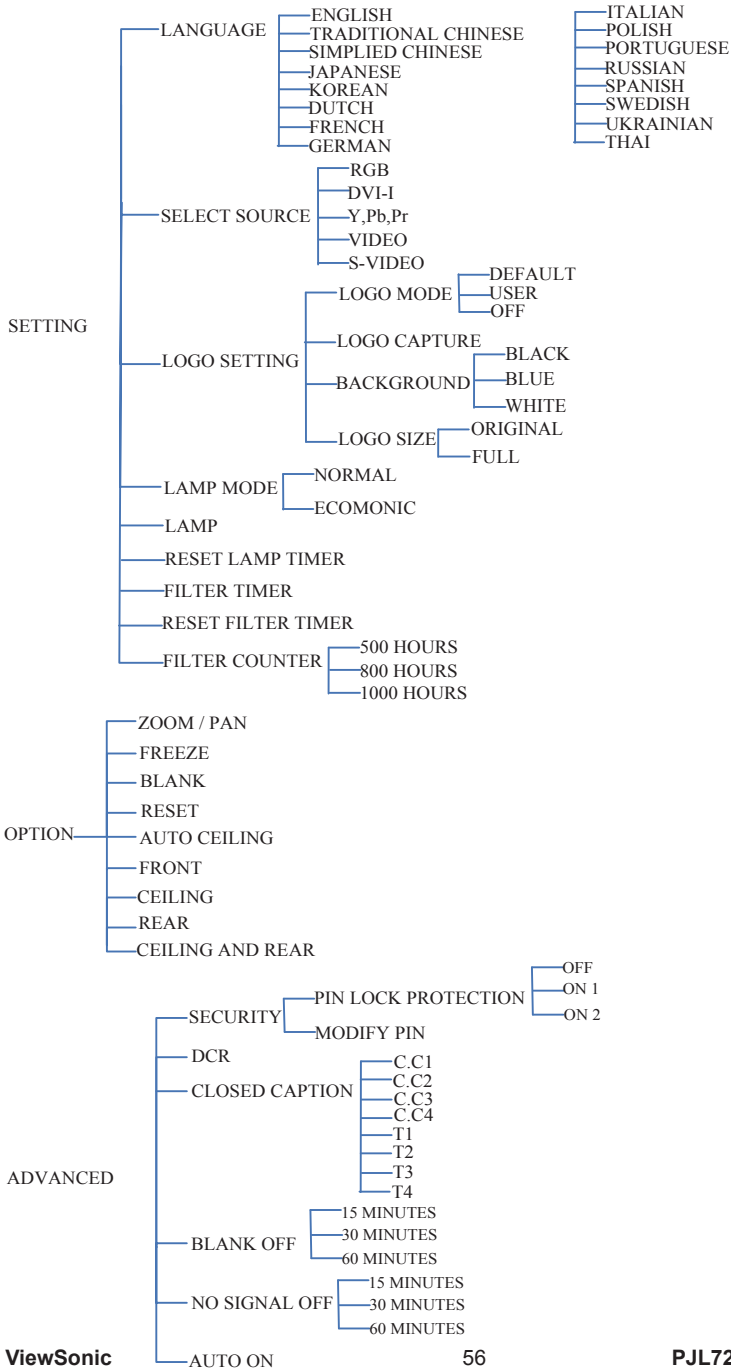

Appendix

Appearance

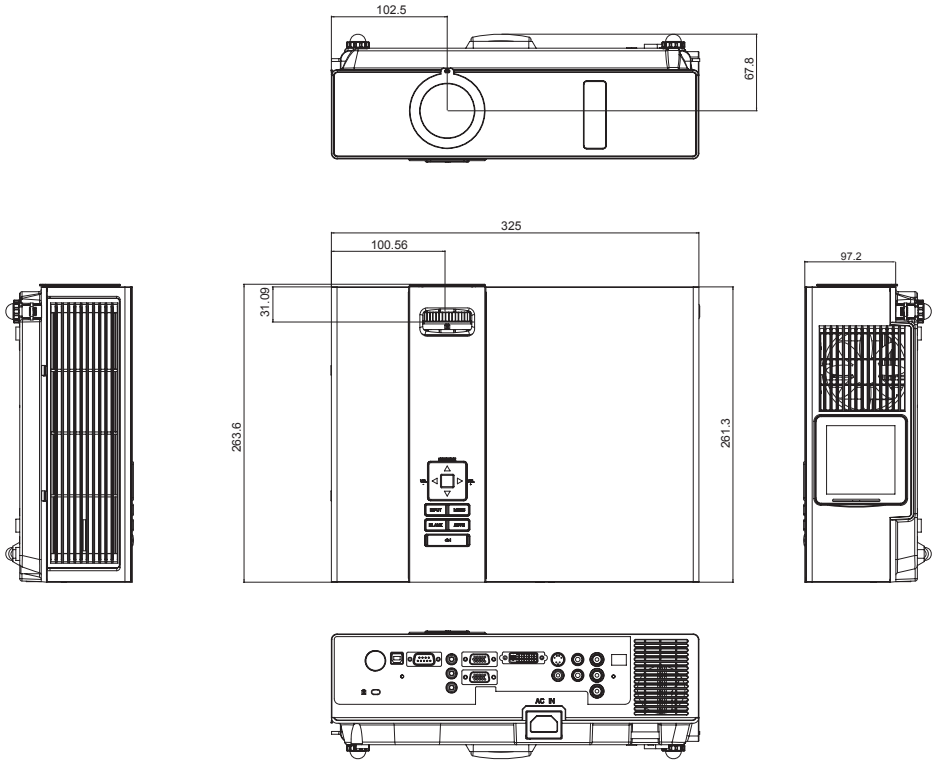

Appendix

Configurations of Terminal (RS232 Control)

① Communication Protocol

| Item | Specification |
|--------------------|---------------|
| Standard Baud rate | 9600 bps |
| Data length | 8 bits |
| Parity | None |
| Stop bit | 1 bit |
| Flow Control | None |

② RS232 Cable Definition

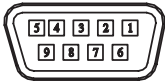

| PC side | Projector side with D-sub pin |
|---------|-------------------------------|
| RX 2 | RX 2 |
| TX 3 | TX 3 |
| GND 5 | GND 5 |

③ Command Transference Protocol

TYPE1 Code :

Example: Power ON command is sent to the projector with a CR, the projector returns a “06” code.

| Command (ASII) | | | | | | | | | | | | | | | |
|----------------|-----------|--|--|---|---|---|----|-----------------------|--|---|---|---|---|--|--|
| | PC | | | C | 0 | 0 | CR | | | | | 0 | 6 | | |
| | Projector | | | | | | | Processing Command | | 0 | 6 | | | | |

Appendix

Configurations of Terminal (RS232 Control)

④ Command List

| TYPE1 Command (HEX+CR) | Function | Remarks |
|------------------------|---------------|---|
| C00(43 30 30 0D) | POWER ON | |
| C01(43 30 31 0D) | POWER OFF | |
| C02(43 30 32 0D) | RGB | |
| C03(43 30 33 0D) | Y,Pb,Pr | |
| C05(43 30 35 0D) | DVI | |
| C06(43 30 36 0D) | VIDEO | |
| C07(43 30 37 0D) | S-VIDEO | |
| C09(43 30 39 0D) | VOLUME+ | |
| C0A(43 30 40 0D) | VOLUME- | |
| C1D(43 31 44 0D) | MENU | |
| C30(43 33 30 0D) | UP | |
| C31(43 33 31 0D) | DOWN | |
| C32(43 33 32 0D) | LEFT | |
| C33(43 33 33 0D) | RIGHT | |
| C34(43 33 34 0D) | MUTE | |
| C43(43 34 33 0D) | FREEZE | |
| C80(43 38 33 0D) | ZOOM+ | |
| C81(43 38 31 0D) | ZOOM- | |
| C90(43 39 33 0D) | ESC | |
| C91(43 39 31 0D) | SOURCE | |
| C92(43 39 32 0D) | AUTO | |
| C93(43 39 33 0D) | CONTRAST+ | |
| C94(43 39 34 0D) | CONTRAST- | |
| C95(43 39 35 0D) | BRIGHTNESS+ | |
| C96(43 39 36 0D) | BRIGHTNESS- | |
| C97(43 39 37 0D) | BLANK | |
| C98(43 39 38 0D) | KEYSTONE+ | |
| C99(43 39 39 0D) | KEYSTONE- | |
| | | |
| CR0(43 52 30 0D) | POWER-STATUS | STATUS feedback " 000 "-projector is on " 800 "-projector is standby " 200 "-projector is cooling down " 500 "-projector is warm up |
| CR1(43 52 31 0D) | SOURCE-STATUS | STATUS feedback " 001 "-RGB |

Appendix

IR Control Code

Custom Code : 0x6A

Data Code

| No. | DATA | CODE |
|-----|-------|------|
| 1 | POWER | 0x00 |
| 2 | INPUT | 0x11 |
| 3 | MENU | 0x27 |
| 4 | UP | 0x14 |
| 5 | LEFT | 0x16 |
| 6 | RIGHT | 0x18 |
| 7 | DOWN | 0x19 |
| 8 | MUTE | 0x13 |
| 9 | BLANK | 0x23 |
| 10 | AUTO | 0x1F |

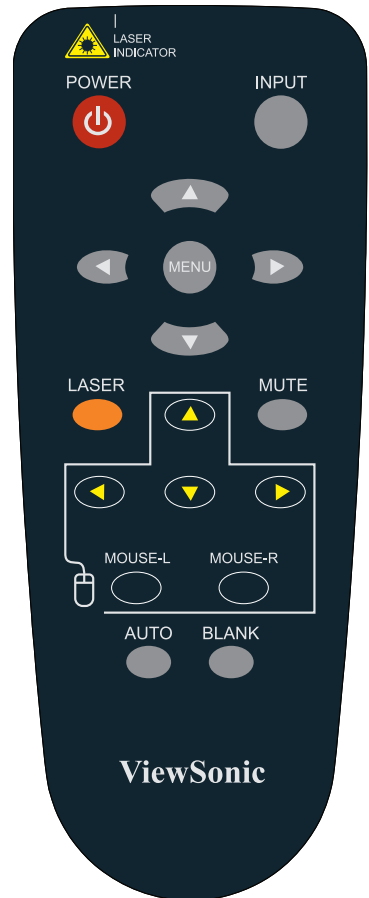

Customer Support

For technical support or product service, see the table below or contact your reseller.

Note : You will need the product serial number.

| Country/Region | Web Site | T=Telephone F=Fax | E-mail |
|---|-----------------------------|---|---|
| Australia/New Zealand | www.viewsonic.com.au | AUS=1800 880 818 NZ=0800 008 822 | service@au.viewsonic.com |
| Canada | www.viewsonic.com | T (Toll-Free)= 1-866-463-4775 T (Toll)= 1-424-233-2533 F= 1-909-468-1202 | service.ca@viewsonic.com |
| Europe/Middle East/Baltic countries/North Africa | www.viewsoniceurope.com | Contact your reseller | |
| Hong Kong | www.hk.viewsonic.com | T= 852 3102 2900 | service@hk.viewsonic.com |
| India | www.in.viewsonic.com | T= 1800 11 9999 | service@in.viewsonic.com |
| Korea | www.kr.viewsonic.com | T= 080 265 9080 | service@kr.viewsonic.com |
| Latin America (Argentina) | www.viewsonic.com/la/ | T= 0800 666 0194 | soporte@viewsonic.com |
| Latin America (Brazil) | www.viewsonic.com/la/ | T= 0800 891 6984 | soporte@viewsonic.com |
| Latin America (Chile) | www.viewsonic.com/la/ | T= 800 440 303 | soporte@viewsonic.com |
| Latin America (Columbia) | www.viewsonic.com/la/ | T= 01 800 915 6588 | soporte@viewsonic.com |
| Latin America (Mexico) | www.viewsonic.com/la/ | T= 001 800 514 6518 | soporte@viewsonic.com |
| Renta y Datos, 29 SUR 721, COL. LA PAZ, 72160 PUEBLA, PUE. Tel: 01.222.891.55.77 CON 10 LINEAS Electroser, Av Reforma No. 403Gx39 y 41, 97000 Merida, Yucatan. Tel: 01.999.925.19.16 Other places please refer to http://www.viewsonic.com/la/soporte/index.htm#Mexico | | | |
| Latin America (Peru) | www.viewsonic.com/la/ | T= 0800 53458 | soporte@viewsonic.com |
| Macau | www.hk.viewsonic.com | T= 853 700 303 | service@hk.viewsonic.com |
| Puerto Rico & Virgin Islands | www.viewsonic.com | T= 1-800-688-6688 (English) T= 1-866-379-1304 (Spanish) F= 1-909-468-1202 | service.us@viewsonic.com soporte@viewsonic.com |
| Singapore/Malaysia/Thailand | www.ap.viewsonic.com | T= 65 6461 6044 | service@sg.viewsonic.com |
| South Africa | www.viewsoniceurope.com | www.viewsoniceurope.com/uk/Support/Calldesk.htm | |
| United Kingdom | www.viewsoniceurope.com/uk/ | www.viewsoniceurope.com/uk/Support/Calldesk.htm | |
| United States | www.viewsonic.com | T (Toll-Free)= 1-800-688-6688 T (Toll)= 1-424-233-2530 F= 1-909-468-1202 | service.us@viewsonic.com |

Limited Warranty

VIEWSONIC® PROJECTOR

What the warranty covers:

ViewSonic warrants its products to be free from defects in material and workmanship, under normal use, during the warranty period. If a product proves to be defective in material or workmanship during the warranty period, ViewSonic will, at its sole option, repair or replace the product with a like product. Replacement product or parts may include remanufactured or refurbished parts or components.

How long the warranty is effective:

North and South America: 3 years for all parts excluding the lamp, 3 years for labor, 1 year for the original lamp from the date of the first consumer purchase.

Europe: 3 years for all parts excluding the lamp, 3 years for labor, 1 year for the original lamp from the date of the first consumer purchase.

Other regions or countries: Please check with your local dealer or local ViewSonic office for the warranty information.

Lamp warranty subject to terms and conditions, verification and approval. Applies to manufacturer's installed lamp only.

All accessory lamps purchased separately are warranted for 90 days.

Who the warranty protects:

This warranty is valid only for the first consumer purchaser.

What the warranty does not cover:

1. Any product on which the serial number has been defaced, modified or removed.
2. Damage, deterioration or malfunction resulting from:
 - a. Accident, misuse, neglect, fire, water, lightning, or other acts of nature, unauthorized product modification, or failure to follow instructions supplied with the product.
 - b. Repair or attempted repair by anyone not authorized by ViewSonic.
 - c. Any damage of the product due to shipment.
 - d. Removal or installation of the product.
 - e. Causes external to the product, such as electric power fluctuations or failure.
 - f. Use of supplies or parts not meeting ViewSonic's specifications.
 - g. Normal wear and tear.
 - h. Any other cause which does not relate to a product defect.
3. Any product exhibiting a condition commonly known as "image burn-in" which results when a static image is displayed on the product for an extended period of time.
4. Removal, installation, and set-up service charges.

How to get service:

1. For information about receiving service under warranty, contact ViewSonic Customer Support (please refer to "Customer Support" page). You will need to provide your product's serial number.
2. To obtain warranted service, you will be required to provide (a) the original dated sales slip, (b) your name, (c) your address, (d) a description of the problem, and (e) the serial number of the product.
3. Take or ship the product freight prepaid in the original container to an authorized ViewSonic service center or ViewSonic.
4. For additional information or the name of the nearest ViewSonic service center, contact ViewSonic.

Limitation of implied warranties:

There are no warranties, express or implied, which extend beyond the description contained herein including the implied warranty of merchantability and fitness for a particular purpose.

Exclusion of damages:

ViewSonic's liability is limited to the cost of repair or replacement of the product. ViewSonic shall not be liable for:

1. Damage to other property caused by any defects in the product, damages based upon inconvenience, loss of use of the product, loss of time, loss of profits, loss of business opportunity, loss of goodwill, interference with business relationships, or other commercial loss, even if advised of the possibility of such damages.
2. Any other damages, whether incidental, consequential or otherwise.
3. Any claim against the customer by any other party.

Effect of state law:

This warranty gives you specific legal rights, and you may also have other rights which vary from state to state. Some states do not allow limitations on implied warranties and/or do not allow the exclusion of incidental or consequential damages, so the above limitations and exclusions may not apply to you.

Sales outside the U.S.A. and Canada:

For warranty information and service on ViewSonic products sold outside of the U.S.A. and Canada, contact ViewSonic or your local ViewSonic dealer.

The warranty period for this product in mainland China (Hong Kong, Macao and Taiwan Excluded) is subject to the terms and conditions of the Maintenance Guarantee Card.

For users in Europe and Russia, full details of warranty provided can be found in www.viewsoniceurope.com under Support/Warranty Information.

Mexico Limited Warranty

VIEWSONIC® PROJECTOR

What the warranty covers:

ViewSonic warrants its products to be free from defects in material and workmanship, under normal use, during the warranty period. If a product proves to be defective in material or workmanship during the warranty period, ViewSonic will, at its sole option, repair or replace the product with a like product. Replacement product or parts may include remanufactured or refurbished parts or components & accessories.

How long the warranty is effective:

3 years for all parts excluding the lamp, 3 years for labor, 1 year for the original lamp from the date of the first consumer purchase.

Lamp warranty subject to terms and conditions, verification and approval. Applies to manufacturer's installed lamp only. All accessory lamps purchased separately are warranted for 90 days.

Who the warranty protects:

This warranty is valid only for the first consumer purchaser.

What the warranty does not cover:

1. Any product on which the serial number has been defaced, modified or removed.
2. Damage, deterioration or malfunction resulting from:
 - a. Accident, misuse, neglect, fire, water, lightning, or other acts of nature, unauthorized product modification, unauthorized attempted repair, or failure to follow instructions supplied with the product.
 - b. Any damage of the product due to shipment.
 - c. Causes external to the product, such as electrical power fluctuations or failure.
 - d. Use of supplies or parts not meeting ViewSonic's specifications.
 - e. Normal wear and tear.
 - f. Any other cause which does not relate to a product defect.
3. Any product exhibiting a condition commonly known as "image burn-in" which results when a static image is displayed on the product for an extended period of time.
4. Removal, installation, insurance, and set-up service charges.

How to get service:

For information about receiving service under warranty, contact ViewSonic Customer Support (Please refer to the attached Customer Support page). You will need to provide your product's serial number, so please record the product information in the space provided below on your purchase for your future use. Please retain your receipt of proof of purchase to support your warranty claim.

For Your Records

Product Name: _____ Model Number: _____
Document Number: _____ Serial Number: _____
Purchase Date: _____ Extended Warranty Purchase? _____ (Y/N)
If so, what date does warranty expire? _____

1. To obtain warranty service, you will be required to provide (a) the original dated sales slip, (b) your name, (c) your address, (d) a description of the problem, and (e) the serial number of the product.
2. Take or ship the product in the original container packaging to an authorized ViewSonic service center.
3. Round trip transportation costs for in-warranty products will be paid by ViewSonic.

Limitation of implied warranties:

There are no warranties, express or implied, which extend beyond the description contained herein including the implied warranty of merchantability and fitness for a particular purpose.

Exclusion of damages:

ViewSonic's liability is limited to the cost of repair or replacement of the product. ViewSonic shall not be liable for:

1. Damage to other property caused by any defects in the product, damages based upon inconvenience, loss of use of the product, loss of time, loss of profits, loss of business opportunity, loss of goodwill, interference with business relationships, or other commercial loss, even if advised of the possibility of such damages.
2. Any other damages, whether incidental, consequential or otherwise.
3. Any claim against the customer by any other party.
4. Repair or attempted repair by anyone not authorized by ViewSonic.

| Contact Information for Sales & Authorized Service (Centro Autorizado de Servicio) within Mexico: | |
|--|---|
| Name, address, of manufacturer and importers: México, Av. de la Palma #8 Piso 2 Despacho 203, Corporativo Interpalmas, Col. San Fernando Huixquilucan, Estado de México Tel: (55) 3605-1099 http://www.viewsonic.com/la/soporte/index.htm | |
| NÚMERO GRATIS DE ASISTENCIA TÉCNICA PARA TODO MÉXICO: 001.866.823.2004 | |
| Hermosillo: Distribuciones y Servicios Computacionales SA de CV. Calle Juarez 284 local 2 Col. Bugambilias C.P: 83140 Tel: 01-66-22-14-9005 E-Mail: disc2@hmo.megared.net.mx | Villahermosa: Compumantenimietnos Garantizados, S.A. de C.V. AV. GREGORIO MENDEZ #1504 COL, FLORIDA C.P. 86040 Tel: 01 (993) 3 52 00 47 / 3522074 / 3 52 20 09 E-Mail: compumantenimientos@prodigy.net.mx |
| Puebla, Pue. (Matriz): RENTA Y DATOS, S.A. DE C.V. Domicilio: 29 SUR 721 COL. LA PAZ 72160 PUEBLA, PUE. Tel: 01(52).222.891.55.77 CON 10 LINEAS E-Mail: datos@puebla.megared.net.mx | Veracruz, Ver.: CONEXION Y DESARROLLO, S.A DE C.V. Av. Americas # 419 ENTRE PINZÓN Y ALVARADO Fracc. Reforma C.P. 91919 Tel: 01-22-91-00-31-67 E-Mail: gacosta@qplus.com.mx |
| Chihuahua Soluciones Globales en Computación C. Magisterio # 3321 Col. Magisterial Chihuahua, Chih. Tel: 4136954 E-Mail: Cefeo@soluglobales.com | Cuernavaca Compusupport de Cuernavaca SA de CV Francisco Leyva # 178 Col. Miguel Hidalgo C.P. 62040, Cuernavaca Morelos Tel: 01 777 3180579 / 01 777 3124014 E-Mail: aquevedo@compusupportcva.com |
| Distrito Federal: QPLUS, S.A. de C.V. Av. Coyoacán 931 Col. Del Valle 03100, México, D.F. Tel: 01(52)55-50-00-27-35 E-Mail : gacosta@qplus.com.mx | Guadalajara, Jal.: SERVICRECE, S.A. de C.V. Av. Niños Héroeas # 2281 Col. Arcos Sur, Sector Juárez 44170, Guadalajara, Jalisco Tel: 01(52)33-36-15-15-43 E-Mail: mmiranda@servicrece.com |
| Guerrero Acapulco GS Computación (Grupo Sesicomp) Progreso #6-A, Colo Centro 39300 Acapulco, Guerrero Tel: 744-48-32627 | Monterrey: Global Product Services Mar Caribe # 1987, Esquina con Golfo Pérsico Fracc. Bernardo Reyes, CP 64280 Monterrey N.L. México Tel: 8129-5103 E-Mail: aydeem@gps1.com.mx |
| MERIDA: ELECTROSER Av Reforma No. 403Gx39 y 41 Mérida, Yucatán, México CP97000 Tel: (52) 999-925-1916 E-Mail: rrrb@sureste.com | Oaxaca, Oax.: CENTRO DE DISTRIBUCION Y SERVICIO, S.A. de C.V. Murguía # 708 P.A., Col. Centro, 68000, Oaxaca Tel: 01(52)95-15-15-22-22 Fax: 01(52)95-15-13-67-00 E-Mail: gpotai2001@hotmail.com |
| Tijuana: STD Av Ferrocarril Sonora #3780 L-C Col 20 de Noviembre Tijuana, Mexico | FOR USA SUPPORT: ViewSonic Corporation 381 Brea Canyon Road, Walnut, CA. 91789 USA Tel: 800-688-6688 (English); 866-323-8056 (Spanish); Fax: 1-800-685-7276 E-Mail: http://www.viewsonic.com |

