

**SANYO**

**Multimedia Projector  
MODEL PLV-Z4000**

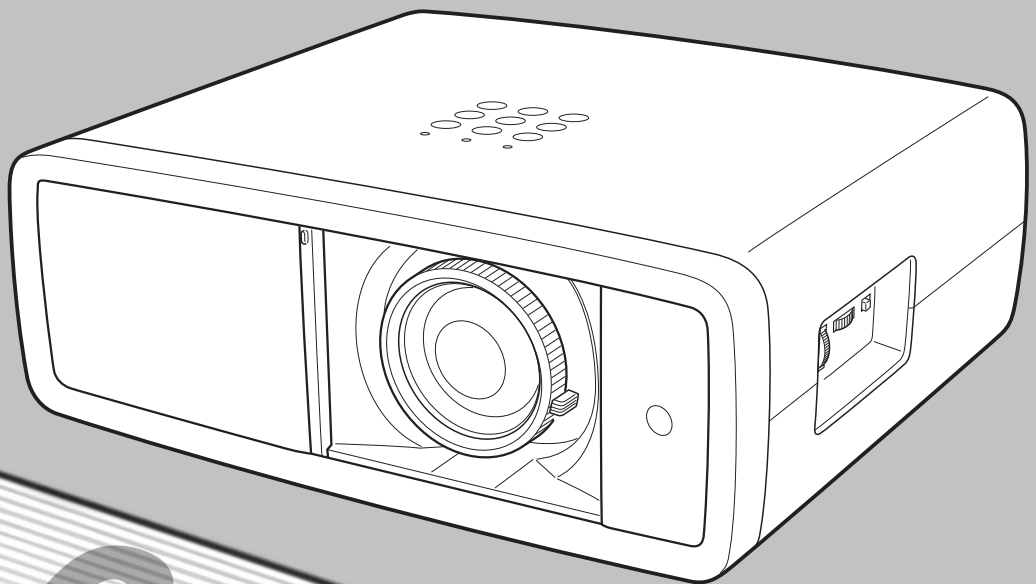

**PROJECTOR**

**Owner's Manual**

# Features and Design

This Multimedia Projector is designed with the most advanced technology for portability, durability, and ease of use. It uses built-in multimedia features, a palette of 1.07 billion colors, and matrix liquid crystal display (LCD) technology.

## ◆ **Short Throw & Wide-Range Zoom Lens**

The 2x Short Throw & Wide-Range Zoom Lens is capable of throwing a 100" diagonal image from a distance of 9.8' (3.0 m) to 20.0' (6.1 m).

## ◆ **Lens Shift**

The Lens Shift function provides a greater installation flexibility. You can use the projector at desired places without images being distorted (*see page 14*).

## ◆ **Color Management**

The Color management function allows you to adjust the details of picture colors to suit your preference and viewing environments (*see pages 32 – 33*).

## ◆ **Auto Iris**

The integration of the lamp aperture enhances the contrast and depth of the projected image.

## ◆ **Compatibility**

The projector accepts signals from multiple sources: computers, analog TV systems (PAL, SECAM, NTSC, NTSC4.43, PAL-M, and PAL-N), component video, S-video, RGB scart, and HDMI.

## ◆ **Simple Computer System Setting**

The Multi-scan system of the projector conforms to almost all computer output signals quickly (*see page 26*).

## ◆ **16 : 9 Wide Screen**

The wide LCD panels with 1920 x 1080 resolution (16:9 aspect ratio) can project the image from component video signals such as DVD players and HDTV devices in full screen.

## ◆ **Interlace-Progressive Conversion**

High-quality picture technology is available that converts an interlaced signal into a progressively-scanned one (*see page 29*).

## ◆ **Automatic Slide Shutter**

The automatic slide shutter protects the lens from dust and scratches. It opens and closes automatically as you press the POWER ON/STAND-BY button.

## ◆ **Wide Selection of Image Modes**

You can select an ideal image mode for the viewing environment or for your desired picture quality (*see page 27*). The seven different kinds of images of your choice can also be stored (*see pages 28 – 33*).

## ◆ **Power Management**

The Power management function reduces power consumption and maintains the lamp life (*see page 41*).

## ◆ **Logo**

The Logo function allows you to customize the screen logo (*see page 40*). You can capture an image for the screen logo and use it for the starting-up display or between presentations.

## ◆ **Lamp Control**

The brightness of the projection lamp can be selected (*see pages 23, 29*).

## ◆ **Multi-language Menu Display**

Operation menu is available in 16 languages: English, German, French, Italian, Spanish, Portuguese, Dutch, Swedish, Finnish, Polish, Hungarian, Romanian, Russian, Chinese, Korean, and Japanese (*see page 37*).

## ◆ **Two HDMI Terminals**

The projector has two HDMI (High Definition Multimedia Interface) terminals. Simple connection with digital equipment is offered through these terminals.

### ✓ **Note:**

- The On-Screen Menu and figures in this manual may differ slightly from the actual product.
- The contents of this manual are subject to change without notice.

# Table of Contents

<b>Features and Design</b> . . . . .	<b>2</b>	<b>Input</b> . . . . .	<b>24</b>
<b>Table of Contents</b> . . . . .	<b>3</b>	Input Source and System Selection	24
<b>To the Owner</b> . . . . .	<b>4</b>	<b>Image</b> . . . . .	<b>27</b>
<b>Safety Instructions</b> . . . . .	<b>5</b>	Image Mode Selection	27
Air Circulation	6	<b>Image Adjustment</b> . . . . .	<b>28</b>
Installing the Projector in Proper Position	6	Image Mode Adjustment	28
Moving the Projector	6	<b>Picture Adjustment</b> . . . . .	<b>34</b>
<b>Compliance</b> . . . . .	<b>7</b>	Picture Position and Screen Adjustment	34
<b>Part Names and Functions</b> . . . . .	<b>8</b>	<b>Screen</b> . . . . .	<b>35</b>
Front	8	Screen Size Adjustment	35
Back	8	<b>Setting</b> . . . . .	<b>37</b>
Bottom	8	Setting	37
Rear Terminal	9	<b>Information</b> . . . . .	<b>43</b>
Top Control	10	Input Source Information Display	43
Remote Control	11	<b>Maintenance and Cleaning</b> . . . . .	<b>44</b>
Remote Control Operating Range	12	Warning Indicator	44
Remote Control Battery Installation	12	Cleaning the RGB panels	45
<b>Installation</b> . . . . .	<b>13</b>	Cleaning the Air Filter	47
Positioning the Projector	13	Resetting the Filter Counter	48
Adjustable Feet	13	Cleaning the Projection Lens	48
Moving the Lens	14	Cleaning the Projector Cabinet	48
Connecting to Video Equipment (Video, S-Video)	15	Lamp Replacement	49
Connecting to Video Equipment (Component)	15	Resetting the Lamp Replacement Counter	50
Connecting to Video Equipment (HDMI, RGB Scart)	16	<b>Appendix</b> . . . . .	<b>51</b>
Connecting to a Computer	16	Troubleshooting	51
Connecting the AC Power Cord	17	Indicators and Projector Condition	53
<b>Basic Operation</b> . . . . .	<b>18</b>	Menu Tree	54
Turning On the Projector	18	System Mode Chart	56
Turning Off the Projector	19	Technical Specifications	57
How to Operate the On-Screen Menu	20	Configurations of Terminals	58
Menu and its Functions	21	Optional Parts	58
Zoom and Focus Adjustment	22	Dimensions	59
Remote Control Operation	22		

---

## TRADEMARKS

- Each name of corporations or products in this owner's manual is either a trademark or a registered trademark of its respective corporation.





# To the Owner

Before installing and operating the projector, read this manual thoroughly.

The projector provides many convenient features and functions. Operating the projector properly enables you to manage those features and maintains it in good condition for many years to come.

Improper operation may result in not only shortening the product life, but also malfunctions, fire hazard, or other accidents.

If your projector seems to operate improperly, read this manual again, check operations and cable connections and try the solutions in the "Troubleshooting" section in the back of this manual. If the problem still persists, contact the dealer where you purchased the projector or the service center.

 <div style="border: 1px solid black; padding: 5px; text-align: center;"><b>CAUTION</b> <b>RISK OF ELECTRIC SHOCK</b> <b>DO NOT OPEN</b></div> 
<b>CAUTION: TO REDUCE THE RISK OF ELECTRIC SHOCK, DO NOT REMOVE COVER (OR BACK). NO USER-SERVICEABLE PARTS INSIDE EXCEPT LAMP REPLACEMENT. REFER SERVICING TO QUALIFIED SERVICE PERSONNEL.</b>
 <b>THIS SYMBOL INDICATES THAT DANGEROUS VOLTAGE CONSTITUTING A RISK OF ELECTRIC SHOCK IS PRESENT WITHIN THIS UNIT.</b>
 <b>THIS SYMBOL INDICATES THAT THERE ARE IMPORTANT OPERATING AND MAINTENANCE INSTRUCTIONS IN THE OWNER'S MANUAL WITH THIS UNIT.</b>

The symbol mark and recycling systems described below apply to EU countries and do not apply to countries in other areas of the world.

Your product is designed and manufactured with high quality materials and components which can be recycled and/or reused.

The symbol mark means that electrical and electronic equipment, batteries and accumulators, at their end-of-life, should be disposed of separately from your household waste.

Note:

If a chemical symbol is printed beneath the symbol mark, this chemical symbol means that the battery or accumulator contains a heavy metal at a certain concentration. This will be indicated as follows: Hg: mercury, Cd: cadmium, Pb: lead. In the European Union there are separate collection systems for used electrical and electronic equipment, batteries and accumulators.

Please, dispose of them correctly at your local community waste collection/recycling centre.

Please, help us to conserve the environment we live in!



**READ AND KEEP THIS OWNER'S MANUAL FOR LATER USE.**



## Safety Precaution

**WARNING: ● THIS APPARATUS MUST BE EARTHED.**  
**● TO REDUCE THE RISK OF FIRE OR ELECTRIC SHOCK, DO NOT EXPOSE THIS APPLIANCE TO RAIN OR MOISTURE.**

- This projector produces intense light from the projection lens. Avoid staring directly into the lens as much as possible, otherwise eye damage could result. Be especially careful that children do not stare directly into the beam.
- Install the projector in a proper position. Otherwise it may result in fire hazard.
- Allowing the proper amount of space on the top, sides, and rear of the projector cabinet is critical for proper air circulation and cooling of the unit. The dimensions shown here indicate the minimum space required. If the projector is to be built into a compartment or similarly enclosed, these minimum distances must be maintained.
- Do not cover the ventilation slot on the projector. Heat build-up can reduce the service life of your projector, and can also be dangerous.

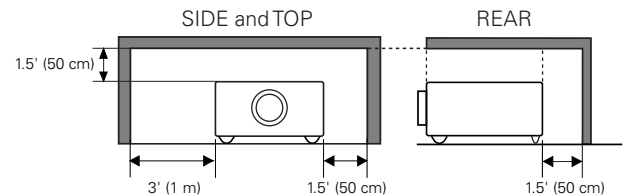

- If the projector is unused for an extended time, unplug the projector from the power outlet.
- Do not project the same image for a long time. The afterimage may remain on the LCD panels by the characteristic of panel.



## CAUTION ON HANGING FROM THE CEILING

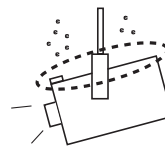

When hanging the projector from the ceiling, clean the air intake vents, air filters, and the top of the projector periodically with a vacuum cleaner. If you leave the projector unclean for a long time, the cooling fans can be clogged with dust, and it may cause a breakdown or a disaster.

**DO NOT SET THE PROJECTOR IN GREASY, WET, OR SMOKY CONDITIONS SUCH AS IN A KITCHEN TO PREVENT A BREAKDOWN OR DISASTER. IF THE PROJECTOR COMES IN CONTACT WITH OIL OR CHEMICALS, IT MAY BECOME DETERIORATED.**

## CAUTION

Not for use in a computer room as defined in the Standard for the Protection of Electronic Computer/Data Processing Equipment, ANSI/NFPA 75.

Ne peut être utilisé dans une salle d'ordinateurs telle que définie dans la norme ANSI/NFPA 75 Standard for Protection of Electronic Computer/Data Processing Equipment.

# Safety Instructions

All the safety and operating instructions should be read before the product is operated.

Read all of the instructions given here and retain them for later use. Unplug this projector from AC power supply before cleaning. Do not use liquid or aerosol cleaners. Use a damp cloth for cleaning.

Follow all warnings and instructions marked on the projector.

For added protection to the projector during lightning storm, or when it is left unattended and unused for long periods of time, unplug it from the wall outlet. This will prevent damage due to lightning and power line surges.

---

Do not expose this unit to rain or use near water... for example, in a wet basement, near a swimming pool, etc...

Do not use attachments not recommended by the manufacturer as they may cause hazards.

Do not place this projector on an unstable cart, stand, or table. The projector may fall, causing serious injury to a child or adult, and serious damage to the projector. Use only with a cart or stand recommended by the manufacturer, or sold with the projector. Wall or shelf mounting should follow the manufacturer's instructions, and should use a mounting kit approved by the manufacturers.

An appliance and cart combination should be moved with care. Quick stops, excessive force, and uneven surfaces may cause the appliance and cart combination to overturn.



---

Slots and openings in the back and bottom of the cabinet are provided for ventilation, to ensure reliable operation of the equipment and to protect it from overheating.

The openings should never be covered with cloth or other materials, and the bottom opening should not be blocked by placing the projector on a bed, sofa, rug, or other similar surface. This projector should never be placed near or over a radiator or heat register.

This projector should not be placed in a built-in installation such as a bookcase unless proper ventilation is provided.

Never push objects of any kind into this projector through cabinet slots as they may touch dangerous voltage points or short out parts that could result in a fire or electric shock. Never spill liquid of any kind on the projector.

Do not install the projector near the ventilation duct of air-conditioning equipment.

This projector should be operated only from the type of power source indicated on the marking label. If you are not sure of the type of power supplied, consult your authorized dealer or local power company.

Do not overload wall outlets and extension cords as this can result in fire or electric shock. Do not allow anything to rest on the power cord. Do not locate this projector where the cord may be damaged by persons walking on it.

Do not attempt to service this projector yourself as opening or removing covers may expose you to dangerous voltage or other hazards. Refer all servicing to qualified service personnel.

Unplug this projector from wall outlet and refer servicing to qualified service personnel under the following conditions:

- When the power cord or plug is damaged or frayed.
- If liquid has been spilled into the projector.
- If the projector has been exposed to rain or water.
- If the projector does not operate normally by following the operating instructions. Adjust only those controls that are covered by the operating instructions as improper adjustment of other controls may result in damage and will often require extensive work by a qualified technician to restore the projector to normal operation.
- If the projector has been dropped or the cabinet has been damaged.
- When the projector exhibits a distinct change in performance, this indicates a need for service.

When replacement parts are required, be sure the service technician has used replacement parts specified by the manufacturer that have the same characteristics as the original part. Unauthorized substitutions may result in fire, electric shock, or injury to persons.

Upon completion of any service or repairs to this projector, ask the service technician to perform routine safety checks to determine that the projector is in safe operating condition.

---

## NOTE FOR CUSTOMERS IN THE US

 LAMP(S) INSIDE THIS PRODUCT CONTAIN MERCURY AND MUST BE RECYCLED OR DISPOSED OF ACCORDING TO LOCAL, STATE OR FEDERAL LAWS.

# Safety Instructions

## Air Circulation

Openings in the cabinet are provided for ventilation. To ensure reliable operation of the product and to protect it from overheating, these openings must not be blocked or covered.

### CAUTION

Hot air is exhausted from the exhaust vent. When using or installing the projector, the following precautions should be taken.

- Do not put any flammable objects or spray can near the projector. Hot air is exhausted from the ventilation holes.
- Keep the exhaust vent at least 3' (1 m) away from any objects.
- Do not touch a peripheral part of the exhaust vent, especially screws and metallic part. This area will become hot while the projector is being used.
- Do not put anything on the projector. Objects put on the cabinet will not only get damaged but also cause fire hazard by heat.

Cooling fans are provided to cool down the projector. The fan's running speed is changed according to the temperature inside the projector.

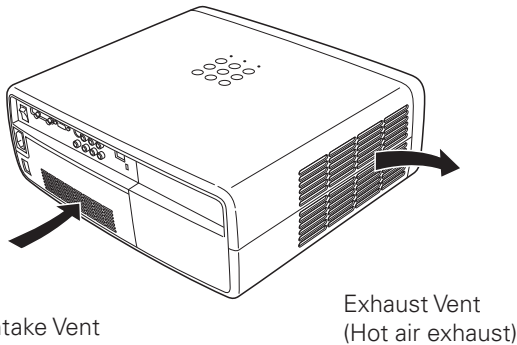

## Moving the Projector

When moving the projector, make sure that the automatic slide shutter is closed, retract the adjustable feet, and lock the lens with the Lens Shift Lock to prevent damage to the lens and cabinet.

When the projector is unused for an extended period, put it into a suitable case.

Care must be taken when handling the projector; do not drop, bump, subject it to strong forces, or put other things on the cabinet.

## Installing the Projector in Proper Position

Install the projector properly. Improper installation may reduce the lamp life and cause fire hazard.

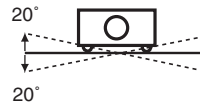

Do not tilt the projector more than 20 degrees from side to side.



**NO UPWARD**

Do not point the projector up to project an image.



**NO DOWNWARD**

Do not point the projector down to project an image.



**NO SIDEWARD**

Do not put the projector on either side to project an image.

### CAUTION

- Set the highland mode properly according to the altitude in which the projector is being used (p.38). Failure to do so may affect the projector life.

### CAUTION ON CEILING MOUNTING

For ceiling mounting, you need the ceiling mount kit designed for this projector. When not mounted properly, the projector may fall, causing hazards or injury. For details, consult your dealer. The warranty on this projector does not cover any damage caused by use of any non-recommended ceiling mount kit or installation of the ceiling mount kit in an improper location.

### CAUTION IN CARRYING OR TRANSPORTING THE PROJECTOR

- Do not drop or bump the projector, otherwise damages or malfunctions may result.
- When carrying the projector, use a suitable carrying case.
- Do not transport the projector by courier or any other transport service in an unsuitable transport case. This may cause damage to the projector. For information about transporting the projector by courier or any other transport service, consult your dealer.
- Do not put the projector in a case before it is cooled enough.

# Compliance

## Federal Communications Commission Notice

This equipment has been tested and found to comply with the limits for a Class B digital device, pursuant to Part 15 of the FCC Rules. These limits are designed to provide reasonable protection against harmful interference in a residential installation. This equipment generates, uses, and can radiate radio frequency energy. If it is not installed and used in accordance with the instructions, it may cause harmful interference to radio communications. However, there is no guarantee that interference will not occur in a particular installation. If this equipment does cause harmful interference to radio or television reception, which can be determined by turning the equipment off and on, the user is encouraged to try to correct the interference by one or more of the following measures:

- Reorient or relocate the receiving antenna.
- Increase the separation between the equipment and receiver.
- Connect the equipment into an outlet on a circuit different from that to which the receiver is connected.
- Consult the dealer or an experienced radio/TV technician for help.

Use of shielded cable is required to comply with class B limits in Subpart B of Part 15 of FCC Rules.

Do not make any changes or modifications to the equipment unless otherwise specified in the instructions. If such changes or modifications should be made, you could be required to stop operation of the equipment.

Model Number(s) : PLV-Z4000  
Trade Name : Sanyo  
Responsible party : SANYO NORTH AMERICA CORPORATION  
Address : 21605 Plummer Street, Chatsworth, California 91311  
Telephone No. : (818)998-7322

## AC Power Cord Requirement

The AC Power Cord supplied with this projector meets the requirement for use in the country you purchased it.

### AC Power Cord for the United States and Canada:

AC Power Cord used in the United States and Canada is listed by the Underwriters Laboratories (UL) and certified by the Canadian Standard Association (CSA).

AC Power Cord has a grounding-type AC line plug. This is a safety feature to be sure that the plug will fit into the power outlet. Do not try to defeat this safety feature. Should you be unable to insert the plug into the outlet, contact your electrician.

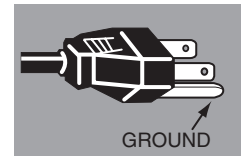

### AC Power Cord for the United Kingdom:

This cord is already fitted with a moulded plug incorporating a fuse, the value of which is indicated on the pin face of the plug. Should the fuse need to be replaced, an ASTA approved BS 1362 fuse must be used of the same rating, marked thus . If the fuse cover is detachable, never use the plug with the cover omitted. If a replacement fuse cover is required, ensure it is of the same colour as that visible on the pin face of the plug (i.e. red or orange). Fuse covers are available from the Parts Department indicated in your User Instructions.

If the plug supplied is not suitable for your socket outlet, it should be cut off and destroyed.

The end of the flexible cord should be suitably prepared and the correct plug fitted.

**WARNING: A PLUG WITH BARED FLEXIBLE CORD IS HAZARDOUS IF ENGAGED IN A LIVE SOCKET OUTLET.**

The Wires in this mains lead are coloured in accordance with the following code:

Green-and-yellow ..... Earth  
Blue ..... Neutral  
Brown ..... Live

As the colours of the wires in the mains lead of this apparatus may not correspond with the coloured markings identifying the terminals in your plug proceed as follows:

The wire which is coloured green-and-yellow must be connected to the terminal in the plug which is marked by the letter E or by the safety earth symbol  or coloured green or green-and-yellow.

The wire which is coloured blue must be connected to the terminal which is marked with the letter N or coloured black.

The wire which is coloured brown must be connected to the terminal which is marked with the letter L or coloured red.

**WARNING: THIS APPARATUS MUST BE EARTHED.**

**THE SOCKET-OUTLET SHOULD BE INSTALLED NEAR THE EQUIPMENT AND EASILY ACCESSIBLE.**

# Part Names and Functions

## Front

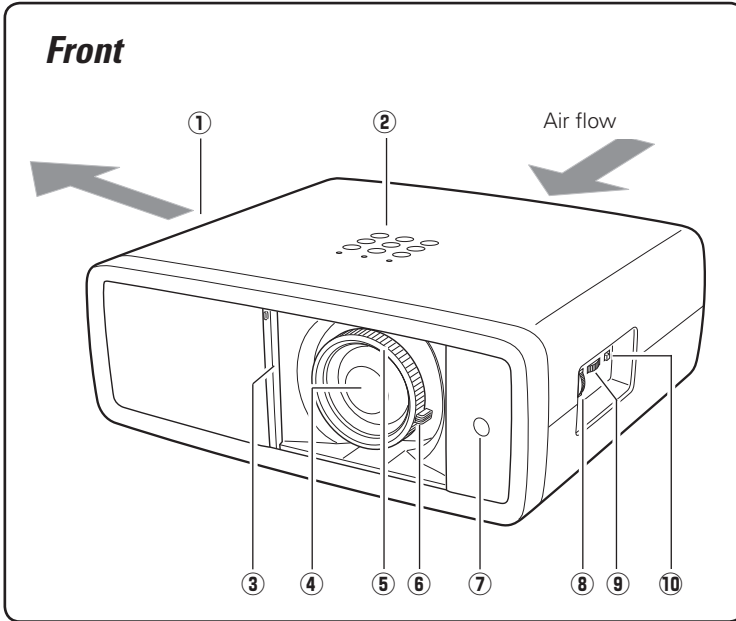

### ① Exhaust Vent



**CAUTION**  
Hot air is exhausted from the exhaust vent. Do not put heat-sensitive objects near this side.

### ② Top Controls and Indicators

### ③ Automatic Slide Shutter

### ④ Projection Lens

### ⑤ Focus Ring

### ⑥ Zoom Lever

### ⑦ Infrared Remote Receiver

### ⑧ Vertical Lens Shift Ring (Up/Down)

### ⑨ Horizontal Lens Shift Ring (Left/Right)

### ⑩ Lens Shift Lock

## Back

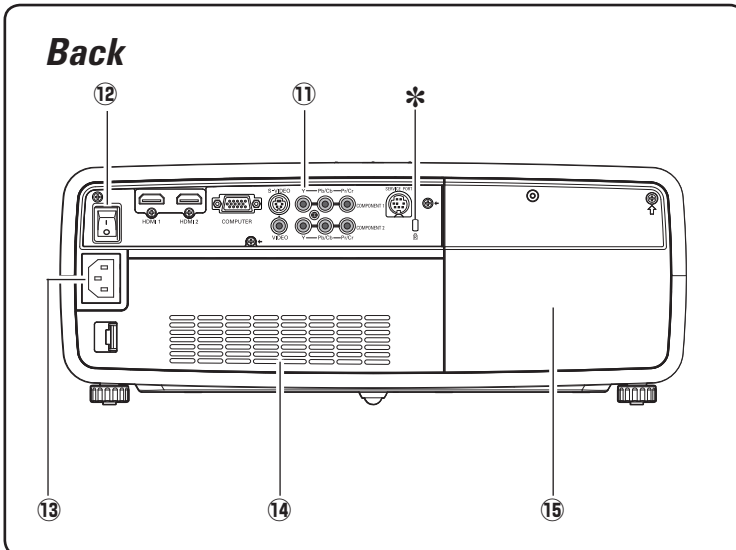

### ⑪ Terminals and Connectors

### ⑫ Main On/Off Switch

### ⑬ Power Cord Connector

### ⑭ Air Intake Vent

### ⑮ Lamp Cover

### \* Kensington Security Slot

This slot is for a Kensington lock used to deter theft of the projector.

\*Kensington is a registered trademark of ACCO Brands Corporation.

## Bottom

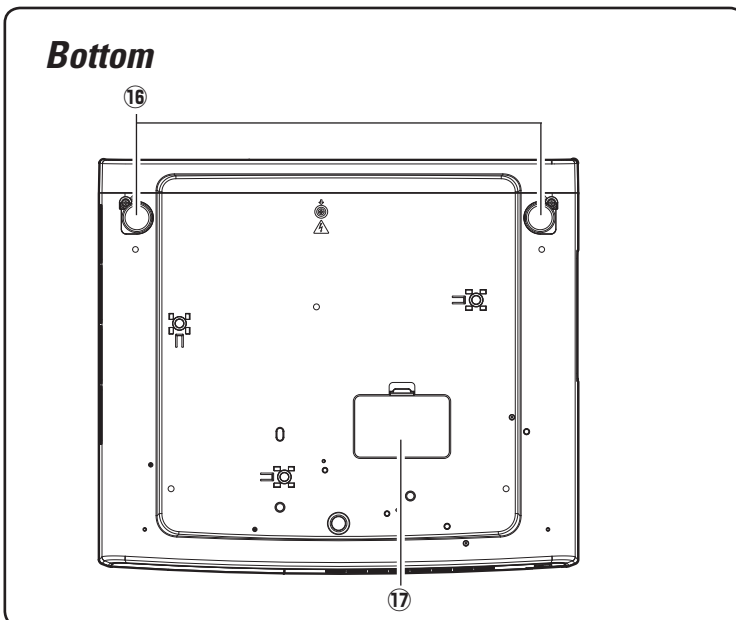

### ⑯ Adjustable Feet

### ⑰ RGB Panel Cleaning Hole Cover



**Rear Terminal**

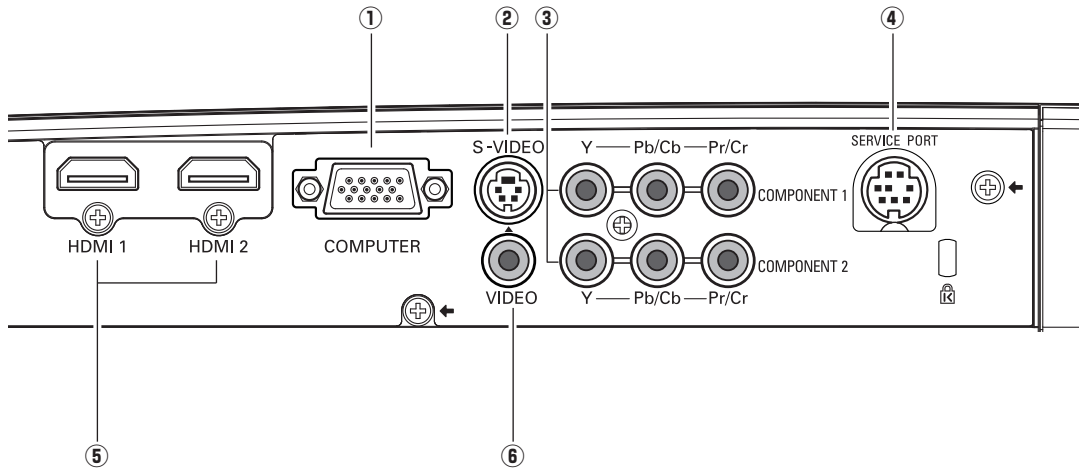

**① COMPUTER**

Connect the computer output signal, or RGB Scart 21-pin video output to this connector (p.16).

**② S-VIDEO**

Connect the S-Video output signal from video equipment to this jack (p.15).

**③ COMPONENT 1 or COMPONENT 2**

Connect the component video output signal to these jacks (p.15).

**④ SERVICE PORT**

This jack is used to service the projector.

**⑤ HDMI 1/HDMI 2\***

Connect the HDMI output signal from video equipment to these terminals (p.16).

**⑥ VIDEO**

Connect the composite video output signal from video equipment to this jack (p.15).

**\*Note on the HDMI connector:**

Use the HDMI connector less than the size shown below. Otherwise you cannot connect use HDMI 1 and HDMI 2 terminals at the same time.

Maximum dimensions of the HDMI connectors

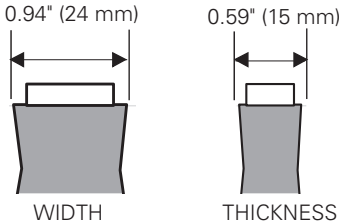

## Top Control

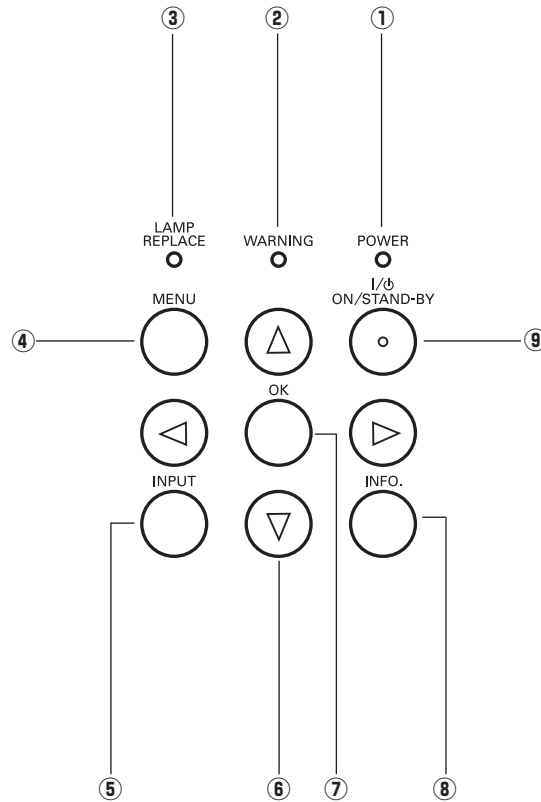

### ① POWER indicator

- Lights red while the projector is in stand-by mode.
- Lights green during operations.
- Blinks red during the cooling-off period.
- Blinks green in the Power management mode (p.41).
- Blinks orange when the automatic slide shutter is closed during operations (p.53).

### ② WARNING indicator

- Lights red light when the projector detects an abnormal condition.
- Blinks red when the internal temperature of the projector exceeds the operating range (pp.44, 53).

### ③ LAMP REPLACE indicator

- Lights yellow light when the projection lamp reaches its end of life (pp.49, 53).

### ④ MENU button

- Open or close the On-Screen Menu (p.20).

### ⑤ INPUT button

- Select an input source (p.24).

### ⑥ POINT ▲▼◀▶ buttons

- Select an item or adjust the setting values in the On-Screen Menu.

### ⑦ OK button

- Execute the item selected or use it to access the submenu items (p.20).

### ⑧ INFO. button

- Display the input source information (p.43).

### ⑨ POWER ON/STAND-BY button

- Turn the projector on or off (pp.18, 19).

## Remote Control

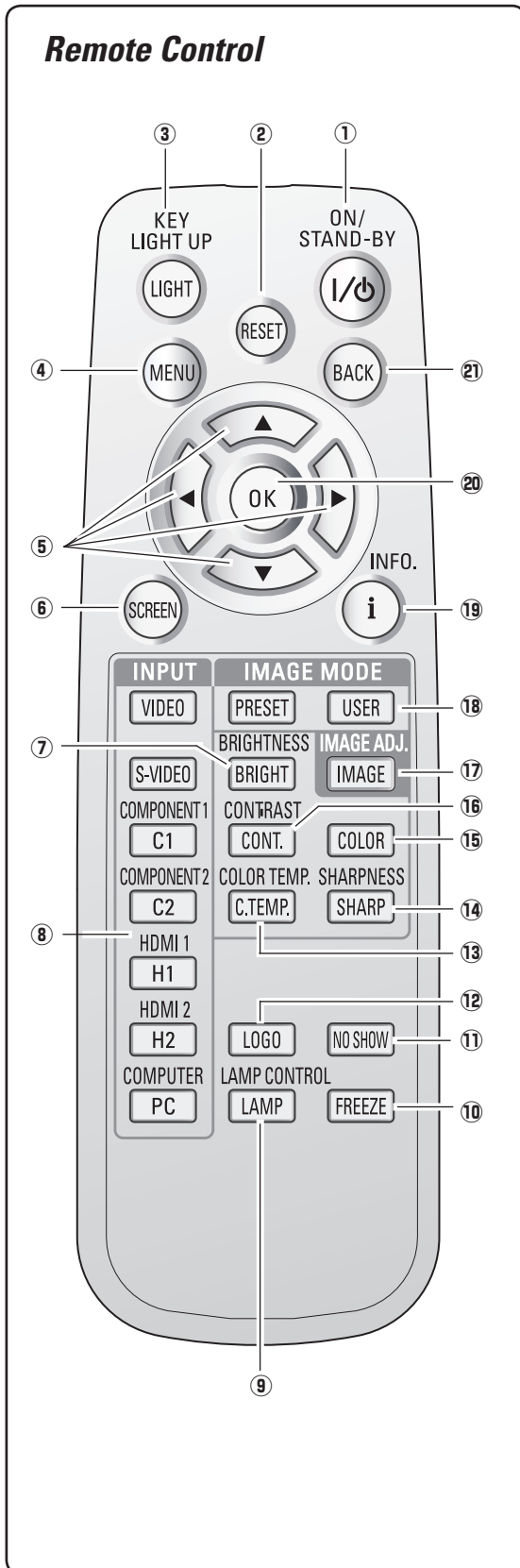

- ① **POWER ON/STAND-BY button**  
Turn the projector on or off (pp.18, 19).
- ② **RESET button**  
Reset to the previous figure.  
This function is limited to when selecting the Image Adjustment (pp.28 – 33) and Picture Adjustment (p.34).
- ③ **LIGHT button**  
Light up the remote control buttons for about 10 seconds (p.22).
- ④ **MENU button**  
Open or close the On-Screen Menu (p.20).
- ⑤ **POINT ▲▼◀▶ buttons**  
Select an item or adjust the setting values in the On-Screen Menu.
- ⑥ **SCREEN button**  
Select a screen size (pp.22, 35).
- ⑦ **BRIGHTNESS button**  
Adjust the brightness of a projected image (pp.23, 28).
- ⑧ **INPUT buttons**  
Select an input source (p.24).
- ⑨ **LAMP CONTROL button**  
Select a lamp mode (pp.23, 29).
- ⑩ **FREEZE button**  
Freeze the projected image (p.23).
- ⑪ **NO SHOW button**  
Temporarily turn off the projected image (p.23).
- ⑫ **LOGO button**  
Display the captured logo (p.23).
- ⑬ **COLORTEMP button**  
Adjust the color temperature of a projected image (p.28).
- ⑭ **SHARPNESS button**  
Adjust the sharpness of a projected image (pp.23, 29).
- ⑮ **COLOR button**  
Adjust the color intensity of a projected image (pp.23, 28).
- ⑯ **CONTRAST button**  
Adjust the contrast of a projected image (pp.23, 28).
- ⑰ **IMAGE ADJ. button**  
Display the Image adj. Menu items one at a time and directly adjust the selected items (pp.23, 28).
- ⑱ **IMAGE MODE buttons**  
Select an image mode (pp.23, 27).
- ⑲ **INFO. button**  
Display the input source information (p.43).
- ⑳ **OK button**  
Execute the selected item or access the sub-menu items (p.20).
- ㉑ **BACK button**  
Return to the previous menu.

✓ **Note:**

- To ensure safe operation, observe the following precautions:
- Do not bend, drop, or expose the remote control to moisture or heat.
  - For cleaning, use a soft dry cloth. Do not apply benzene, thinner, spray, or any other chemicals.

### Remote Control Operating Range

Point the remote control toward the projector (Infrared Remote Receiver) when pressing any buttons. Maximum operating range for the remote control is about 16.4' (5 m) and 60 degrees in front of the projector.

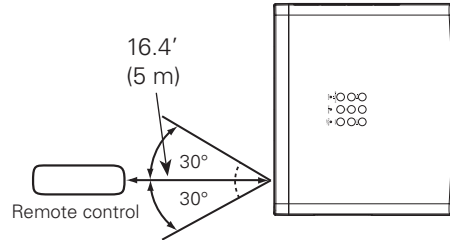

### Remote Control Battery Installation

- 1** Open the battery compartment lid.

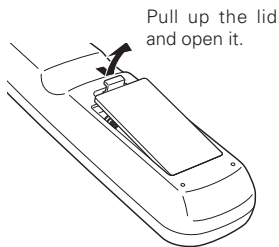

- 2** Install new batteries into the compartment.

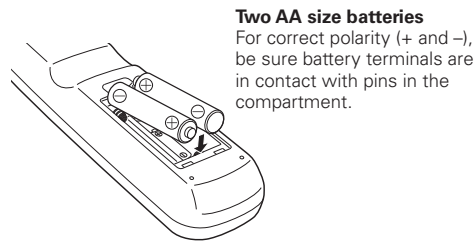

- 3** Replace the compartment lid.

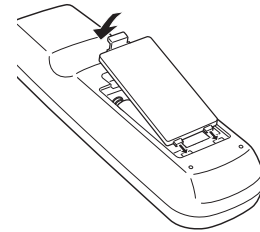

\* When the batteries of the remote control are replaced, the remote control code automatically returns to the initial code (Code 1) (p.41).



To ensure safe operation, please observe the following precautions:

- Use two (2) AA or LR6 type alkaline batteries.
- Always replace batteries in sets.
- Do not use a new battery with a used battery.
- Avoid contact with water or liquid.
- Do not expose the remote control to moisture or heat.
- Do not drop the remote control.
- If the battery has leaked on the remote control, carefully wipe the case clean and install new batteries.
- Risk of explosion if battery is replaced by an incorrect type.
- Dispose of used batteries according to the instructions.

# Installation

## Positioning the Projector

This projector is designed to project on a flat projection surface having a focus range of 3.9' (1.2 m) to 30.2' (9.2 m) at maximum zoom and 7.9' (2.4 m) to 60.4' (18.4 m) at minimum zoom. Refer to the figure and table below for the screen size and distance between the projector and screen.

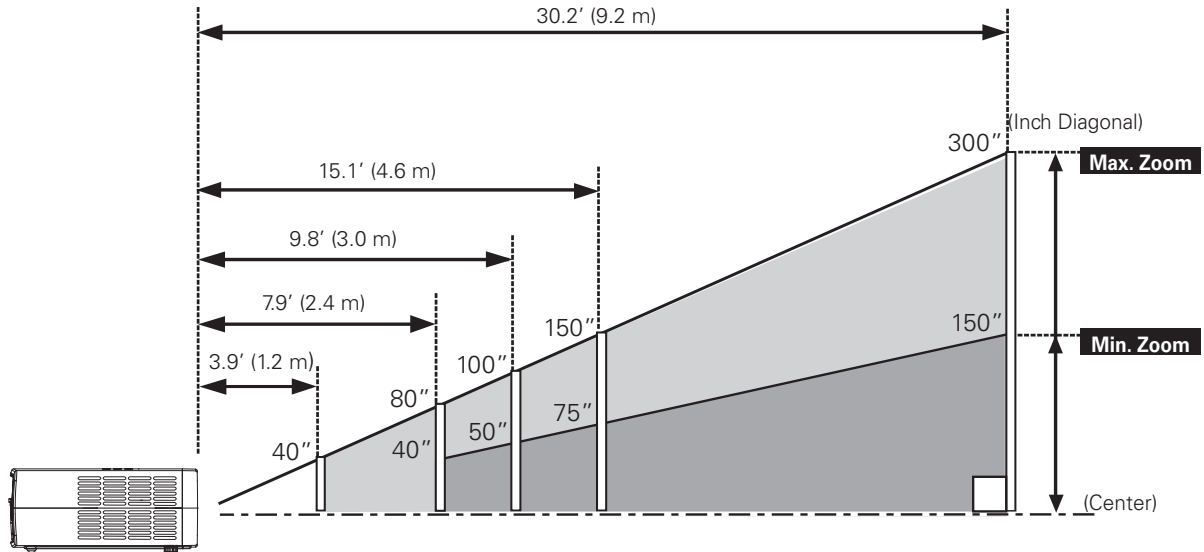

Screen Size (W x H) mm 16 : 9 aspect ratio	40"	80"	100"	150"	300"
	886 x 498	1771 x 996	2214 x 1245	3321 x 1868	6641 x 3736
Zoom (max)	3.9' (1.2 m)	7.9' (2.4 m)	9.8' (3.0 m)	15.1' (4.6 m)	30.2' (9.2 m)
Zoom (min)	7.9' (2.4 m)	16.0' (4.9 m)	20.0' (6.1 m)	30.2' (9.2 m)	60.4' (18.4 m)

### ✓ Note:

- The brightness in the room has a great influence on picture quality. It is recommended to limit ambient lighting in order to obtain the best image.
- All measurements are approximate and may vary from the actual sizes.

## Adjustable Feet

Projection angle can be adjusted up to 6.5 degrees with the adjustable feet.

- 1 Rotate the adjustable feet and tilt the projector to the proper height; to raise the feet, rotate the both feet clockwise.
- 2 To lower or to retract the adjustable feet, rotate the both feet counterclockwise.

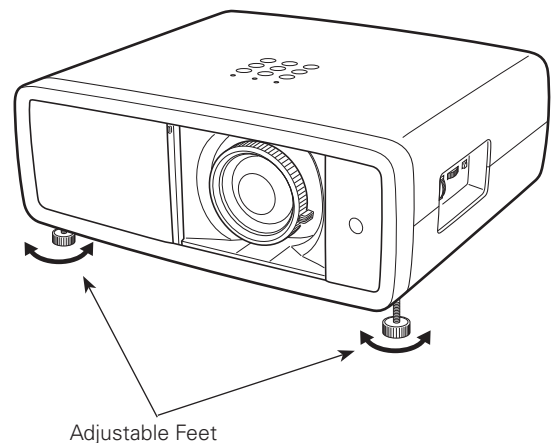

## Moving the Lens

The projection lens can be moved up and down or left and right manually with the Lens Shift Rings, enabling you to adjust the position of a projected image. After adjusting the position, lock the lens with the Lens Shift Lock.

Move the projection lens to the left or right with the Horizontal Lens Shift Ring.

Move the projection lens up or down with the Vertical Lens Shift Ring.

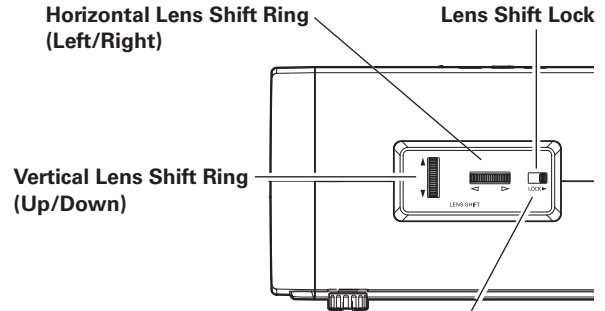

Before using the Lens Shift Rings, make sure that this lock is released.

### Horizontal Lens Shift (Left/Right)

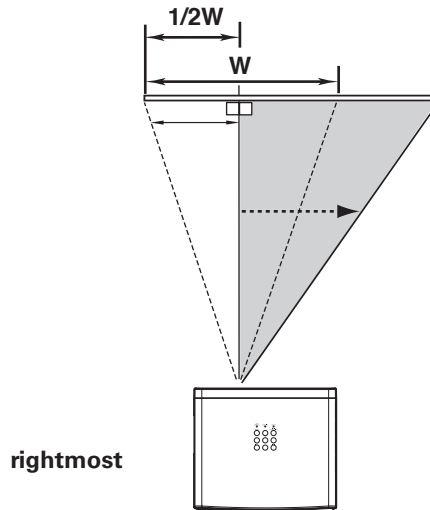
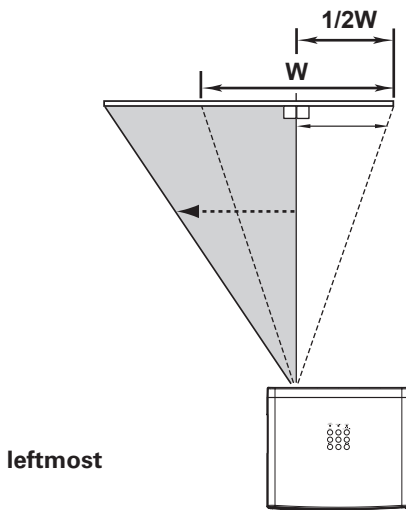

### Vertical Lens Shift (Up/Down)

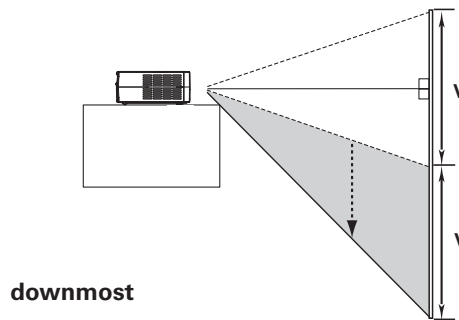
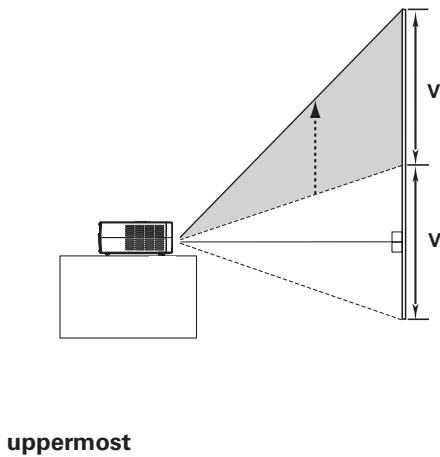

✓ **Note:**

- The best image is generally obtained at the central axis of the lens shift.
- With maximum lens shift in each direction, image distortion may be observed at the edge of the screen.
- With the maximum horizontal lens shift, the maximum vertical lens shift cannot be obtained, and vice versa.
- The Lens Shift Rings are locked at the factory. Make sure that the Lens Shift Lock is released before using the Lens Shift Rings.

This projector can be connected up to six equipment at one time. See the figures below for the connections.

## Connecting to Video Equipment (Video, S-Video)

### Video, S-video

Use a video cable or a S-video cable (commercially available).

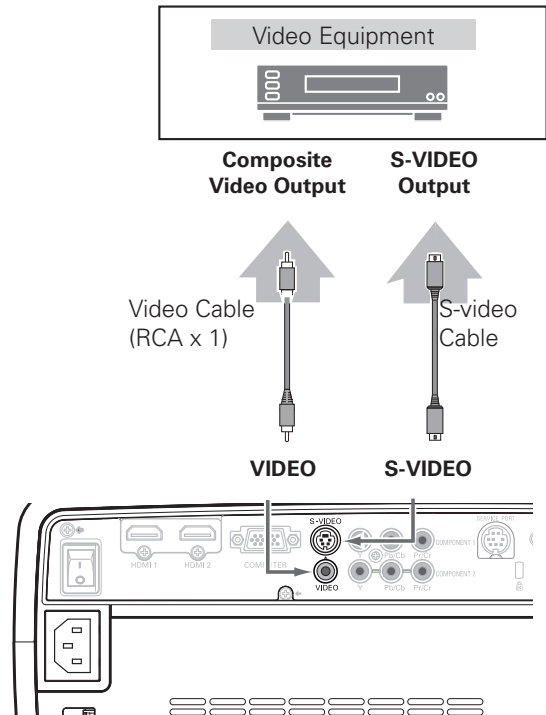

## Connecting to Video Equipment (Component)

### Component

Use a component cable (optional).

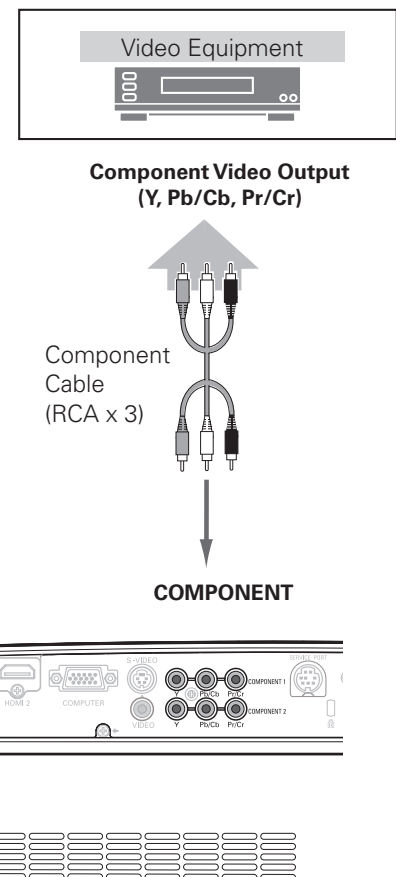

✓ **Note:**

- To order the optional cables, see page 58.
- When connecting HDTV equipment to the projector's COMPONENT 1/2 terminals, horizontal line noise may be noted only occasionally. Then adjust the value of Fine sync. The setting can be adjusted from 0 to +31 (see page 34).



**Unplug the power cords of both the projector and external equipment from the AC outlet before connecting the cables.**

## Connecting to Video Equipment (HDMI, RGB Scart)

### HDMI

Use a HDMI cable (optional) for HDMI output.

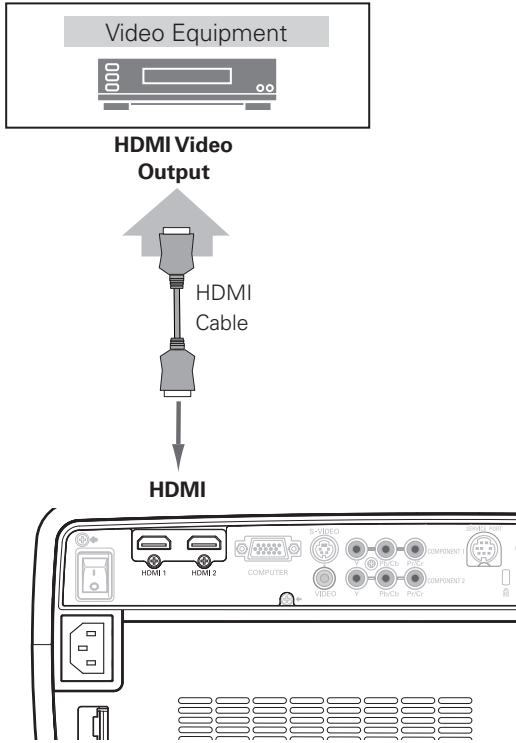

### RGB Scart

Use a Scart-VGA cable (optional).

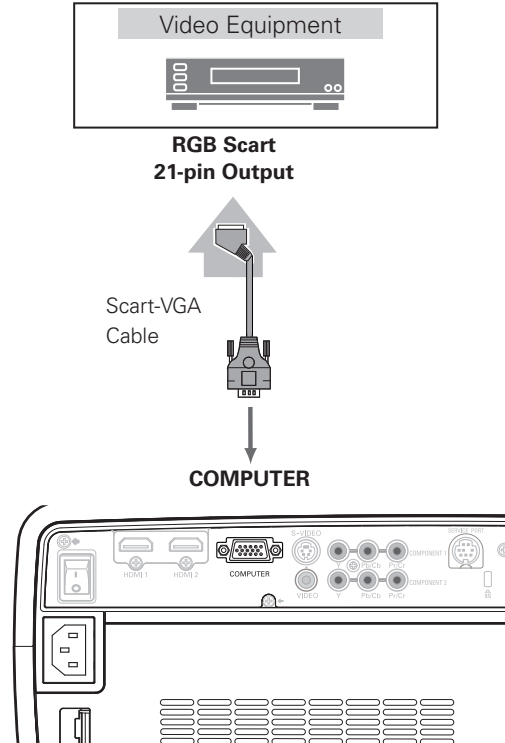

## Connecting to a Computer

### Computer (Analog)

Use a VGA cable (commercially available) or a DVI-VGA cable (commercially available).

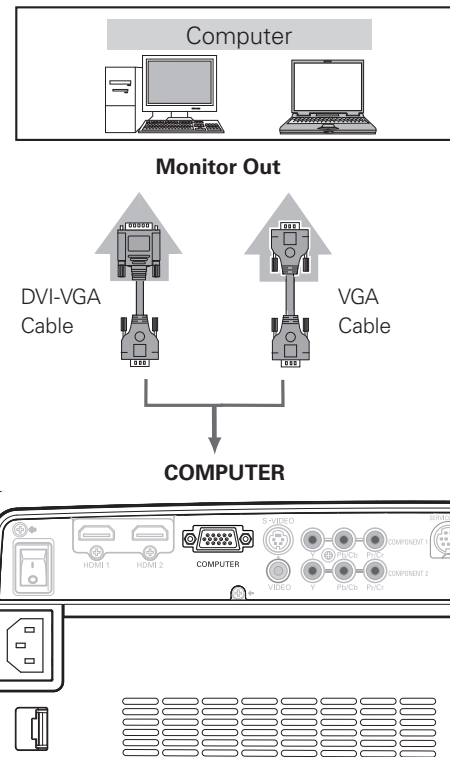

✓ **Note:**

- To order the optional cables, see page 58.



Unplug the power cords of both the projector and external equipment from the AC outlet before connecting the cables.



### Connecting the AC Power Cord

This projector uses nominal input voltages of 100 – 120 V or 200 – 240 V AC and it automatically selects a correct input voltage. It is designed to work with the single-phase power systems having a grounded neutral conductor. To reduce the risk of electrical shock, do not plug into any other type of power system.

If you are not sure of the type of power being supplied, consult your authorized dealer or service station.

Connect the projector with all peripheral equipment before turning it on.

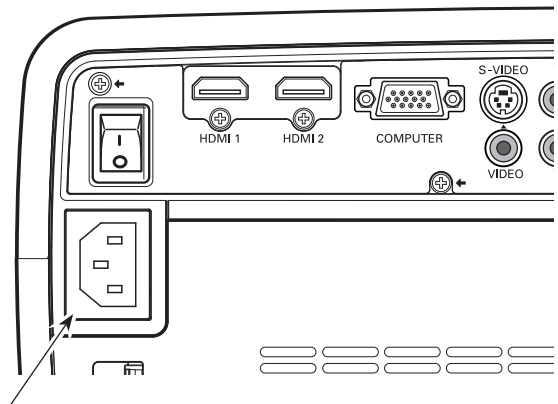

Connect the AC power cord (supplied) to the projector.



**CAUTION**

The AC outlet must be near this equipment and must be easily accessible.

**Note:**

- *Unplug the AC power cord when the projector is not in use. When the projector is connected to an outlet with the AC power cord and the Main On/Off switch is on, it is in stand-by mode and consumes a little electric power. Turn the Main On/Off switch off when the projector is not in use.*

#### NOTE ON THE POWER CORD

AC power cord must meet the requirements of the country where you use the projector. Confirm the AC plug type with the chart below and proper AC power cord must be used. If the supplied AC power cord does not match your AC outlet, contact your sales dealer.

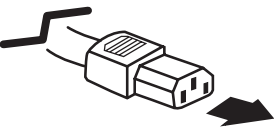
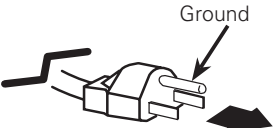
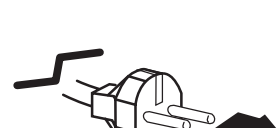
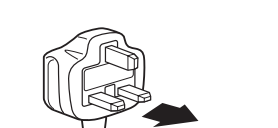
Projector side	AC Outlet side		
 <p>To POWER CORD CONNECTOR on your projector.</p>	<p><b>For the U.S.A. and Canada</b></p>  <p>To the AC Outlet. (120 V AC)</p>	<p><b>For Continental Europe</b></p>  <p>To the AC Outlet. (200–240 V AC)</p>	<p><b>For the U.K.</b></p>  <p>To the AC Outlet. (200–240 V AC)</p>

# Basic Operation

## Turning On the Projector

- 1 Complete peripheral connections (with a computer, VCR, etc.) before turning on the projector.
- 2 Connect the projector's AC power cord into an AC outlet and turn the Main On/Off switch on. The POWER indicator lights red.
- 3 Press the POWER ON/STAND-BY button on the top control or on the remote control.

The POWER indicator turns green and the cooling fans start to operate. As the automatic slide shutter opens, a preparation display appears on the screen and the countdown starts.

- 4 After the countdown, the input source that was selected the last time appears on the screen.

✓ **Note:**

- If the automatic slide shutter does not open properly, the projector will not be turned on and the POWER indicator will blink orange. Press the POWER ON/STAND-BY button again to restart.
- When "Countdown off" or "Off" is selected in the Display function, the countdown will not be displayed on the screen (p.40).
- During the countdown period, all operations are invalid.
- Image may look dark for a while after turning on the projector. Lamp needs some time to stabilize after the power is turned on. Stored lamp mode and the image mode will be active after the lamp is stabilized.
- When the shutter is manually closed slightly during projection, the shutter will be automatically closed.

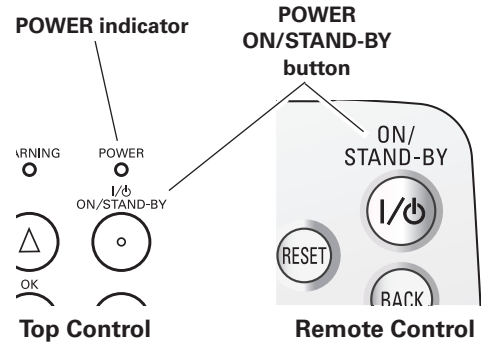
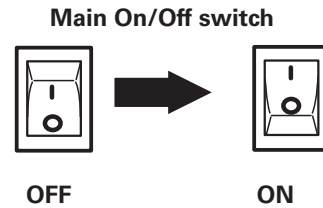

### Selected Input Source



Use this tab when handling manually.

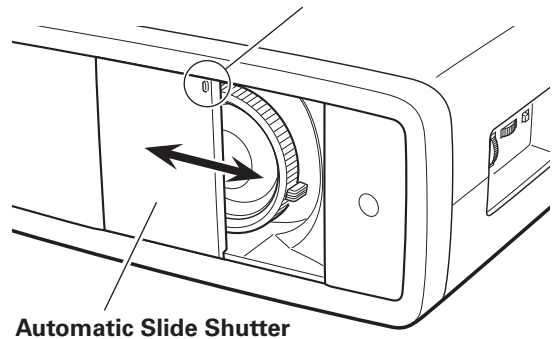

Do not touch the slide shutter while it is moving, as this could cause injury or the projector to malfunction.

## Turning Off the Projector

- 1 Press the POWER ON/STAND-BY button on the top control or on the remote control. "Power off?" appears on the screen. Press the POWER ON/STAND-BY button again to turn off the projector.

When the Power off confirmation function is set to "Off," the projector can be turned off without the confirmation message. (See "Power off confirmation" on page 40.)

The automatic slide shutter closes and the POWER indicator starts to blink red. The blinking continues for about 90 seconds while the cooling fans are running.

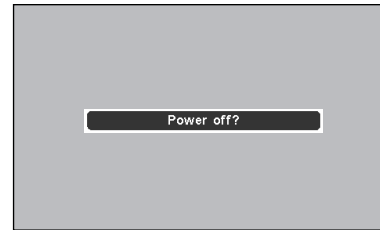

"Power off?" disappears after 4 seconds.

- 2 When the projector is cooled down enough to be turned on again, the POWER indicator stops blinking. Then you can turn the Main On/Off switch off and unplug the AC power cord.



TO MAINTAIN LIFE OF LAMP, ONCE YOU TURN PROJECTOR ON, WAIT AT LEAST FIVE (5) MINUTES BEFORE TURNING IT OFF.

DO NOT PRESS THE MAIN ON/OFF SWITCH TO OFF AND UNPLUG AC POWER CORD WHILE COOLING FANS ARE RUNNING OR BEFORE POWER INDICATOR STOPS BLINKING. OTHERWISE IT WILL RESULT IN SHORTENING LAMP LIFE.



DO NOT OPERATE THE PROJECTOR CONTINUOUSLY WITHOUT REST. CONTINUOUS USE MAY RESULT IN SHORTENING THE LAMP LIFE. TURN OFF THE PROJECTOR AND LET STAND FOR ABOUT AN HOUR IN EVERY 24 HOURS.

✓ **Note:**

- If the automatic slide shutter is closed during operation, the projector is automatically turned off for safety. Be sure to turn off the projector by pressing the POWER ON/STAND-BY button on the top control or on the remote control after use.
- While the POWER indicator is blinking, the lamp is being cooled down and the projector cannot be turned on. Wait until the POWER indicator stops blinking to be turned on again.
- The running speed of cooling fans is changed according to the temperature inside the projector.
- If the WARNING indicator blinks or emits red light, see "Warning Indicator" on page 44.
- Do not put the projector in a case before it is cooled enough.

## How to Operate the On-Screen Menu

The projector can be adjusted or set via the On-Screen Menu. The menus have a hierarchical structure, with a main menu that is divided into submenus, which are further divided into other submenus. For each adjustment and setting procedure, refer to respective sections in this manual.

- 1** Press the MENU button on the top control or on the remote control to display the On-Screen Menu.
- 2** Use the Point ▲▼ buttons to highlight or select a main menu item. Press the Point ► or OK buttons to access the submenu items. (The selected item is highlighted in ORANGE.)
- 3** Use the Point ▲▼ buttons to select the desired submenu item and press the Point ► or OK buttons to access the selected item.
- 4** Use the Point ◀▶ or OK buttons to adjust the setting or switch between each option and press the Point ► or OK buttons to activate it and return to the submenu.
- 5** Press the Point ◀ button to return to the main menu; press the MENU button again to exit the On-Screen Menu.

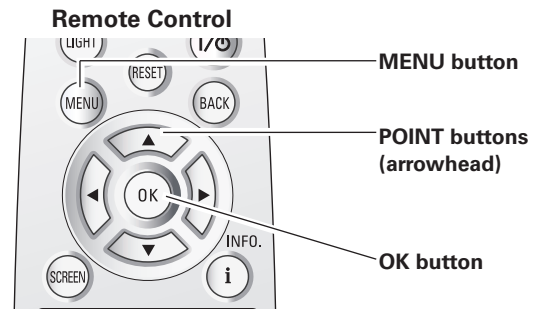
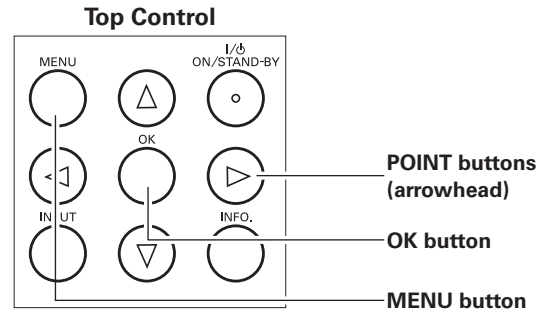

### On-Screen Menu (Main Menu)

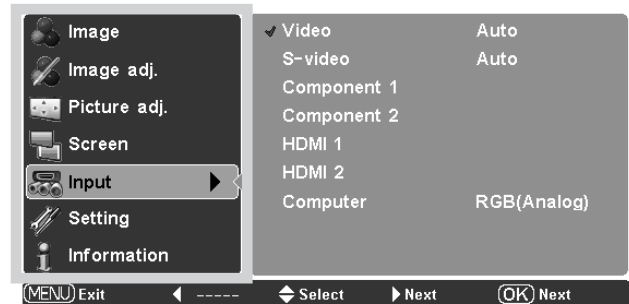

The selected item is highlighted in ORANGE.

### On-Screen Menu (Submenu)

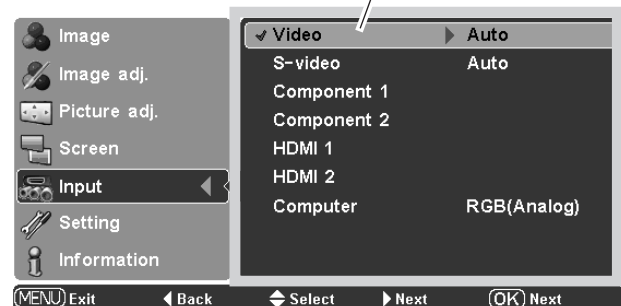

## Menu and its Functions

For the detailed menu contents, see the Menu Tree on pages 54 – 55.

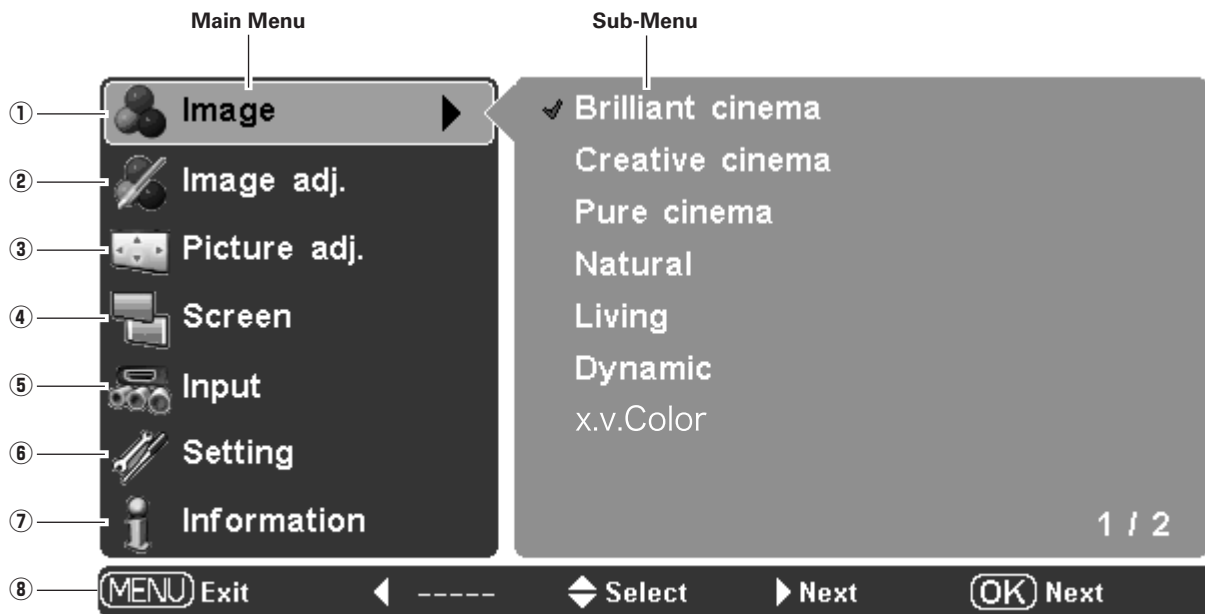

- ① **Image**  
Select an image mode from among Brilliant cinema, Creative cinema, Pure cinema, Natural, Living, Dynamic, x.v.Color, and User image 1 – 7 (p.27).
- ② **Image adj.**  
Adjust Brightness, Contrast, Color, Tint, Color temp., White balance (R/G/B), Sharpness, Lamp control, Gamma, Progressive, Noise reduction, Advanced menu, Reset, and Store (pp.28 – 33).
- ③ **Picture adj.**  
Select Overscan, Horizontal, Vertical, Auto adj., Fine sync, and Total dots to adjust the parameters to match with the input signal format (p.34).
- ④ **Screen**  
Set the screen size; choose from Full, Zoom, Normal, Natural wide , and Anamorphic (pp.35 – 36).
- ⑤ **Input**  
Select an input source from among Video, S-video, Component 1, Component 2, HDMI 1, HDMI 2 , and Computer. For Video and S-video inputs, choose a video system from AUTO, PAL, SECAM, NTSC, NTSC4.43, PAL-M, and PAL-N (pp.24 – 26).
- ⑥ **Setting**  
Change various settings; Language, Advanced menu, Menu position, Ceiling, Rear, HDMI 1 setup, HDMI 2 setup, Highland, Background, Rename, Display, Logo, Power off confirmation, Capture, Power management, Remote control, Shutter demo, Test pattern, Filter counter, Cleaning, Fan control, Lamp counter reset, Service port, and Factory default (pp.37 – 42).
- ⑦ **Information**  
Display the input source information: Input source, Signal, H-sync freq., V-sync freq., Deep color, Image mode, Screen size, Lamp status, Lamp time and Filter time (p.43).
- ⑧ **Guide**  
The key operation is displayed.

## Zoom and Focus Adjustment

Rotate the Zoom Lever to zoom in and out.  
Rotate the Focus Ring to focus the image.

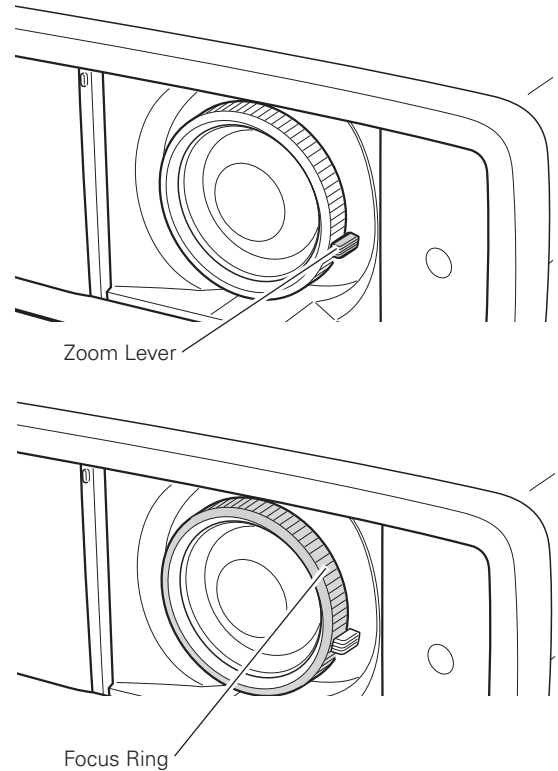

## Remote Control Operation

For some frequently used operations, using the remote control is advisable. Just pressing one of the buttons enables you to have the desired operation quickly, and no need for calling up the On-Screen Menu.

### LIGHT button

Press the LIGHT button to light up the remote control buttons. The light is automatically turned off when no buttons on the remote control are pressed for 10 seconds.

### RESET button

Press the RESET button to reset the adjusted data. All adjustments return to their previous figures. When a main menu item is selected, its entire submenu items are reset; when a submenu item is selected, only the selected item is reset. This function is limited to when selecting the Image Adjustment Menu (pp.28 – 33) and Picture Adjustment Menu (p.34).

### BACK button

Press the BACK button to return to the previous menu. When there is no previous menu, the currently displayed menu disappears.

### SCREEN button

Press the SCREEN button to select the desired screen size. For details, see page 35.

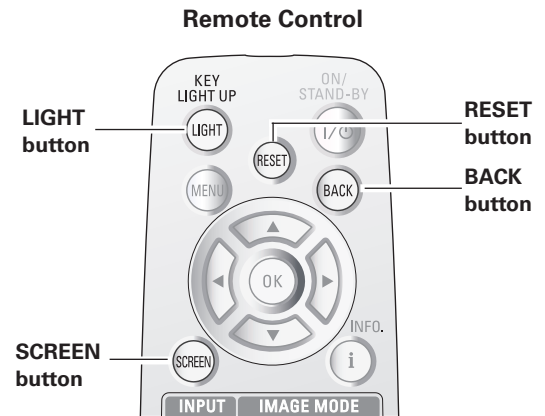

✓ **Note:**

- See the next page for the description of other buttons.

## IMAGE MODE buttons

Press the IMAGE MODE buttons (PRESET or USER) to select the desired image mode of the screen. For details, see page 27 .

## IMAGE ADJ. button

Press the IMAGE ADJ. button to display the adjustment bar of the Image adj. Menu items one at a time and directly adjust the selected item. For details, see page 28.

## BRIGHTNESS button

Press the BRIGHTNESS button to display the Brightness adjustment bar and use the Point ◀▶ buttons to adjust the setting value. Press the MENU button after adjusting. For details, see page 28.

## CONTRAST button

Press the CONTRAST button to display the Contrast adjustment bar and use the Point ◀▶ buttons to adjust the setting value. Press the MENU button after adjusting. For details, see page 28.

## COLOR TEMP. button

Press the COLOR TEMP. button to display the Color temp. adjustment bar and use the Point ◀▶ buttons to select the desired options. Press the MENU button after adjusting. For details, see page 28.

## COLOR button

Press the COLOR button to display the Color adjustment bar and use the Point ◀▶ buttons to adjust the setting value. Press the MENU button after adjusting. For details, see page 28.

## SHARPNESS button





Press the SHARPNESS button to display the Sharpness adjustment bar and use the Point ◀▶ buttons to adjust the setting value. Press the MENU button after adjusting. For details, see page 29.

## LOGO button

Display the image set in the logo setting. To cancel, press the LOGO button again or press any other button. For details, see page 40.

## LAMP CONTROL button

Press the LAMP CONTROL button to select a lamp mode for changing the brightness of the screen.

-  Normal . . . . . Normal brightness.
-  Auto 1 . . . . . The brightness according to the input signal.
-  Auto 2 . . . . . Less bright and lower-sound than Auto 1.
-  Eco . . . . . Lower brightness reduces the lamp power consumption.

The lamp mode is automatically switched to “Eco” under no signal input.

## NO SHOW button

Press the NO SHOW button to black out the image. To restore to normal, press the NO SHOW button again or press any other button.

## FREEZE button

Press the FREEZE button to freeze the picture on the screen. To cancel, press the FREEZE button again or press any other button.

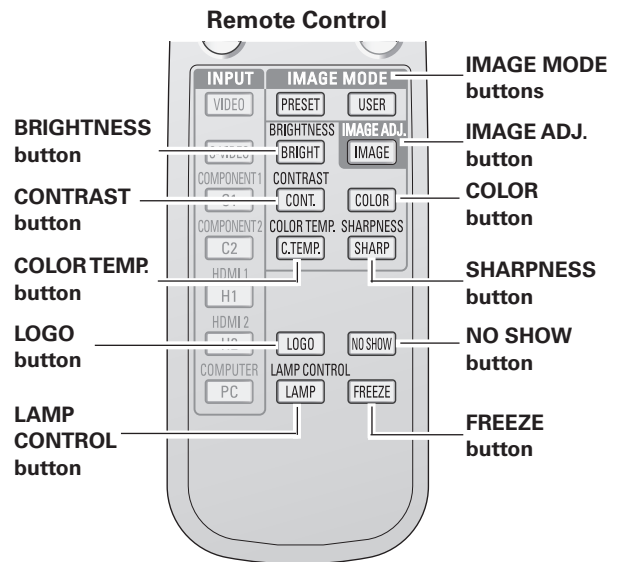

✓ **Note:**

- See the previous page for the description of other buttons.
- If you press the OK button after adjusting each Image adj. Menu item, it will enter the main menu.

✓ **Note:**

- User cannot be selected when the image is not captured.

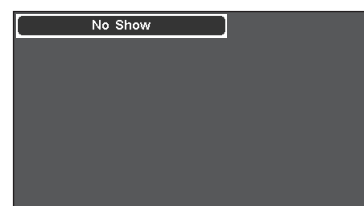

“No Show” disappears after 4 seconds.

# Input

## Input Source and System Selection

Press the INPUT button on the top control or the INPUT buttons on the remote control (see below) to choose an input source.

✓ **Note:**

- Before selecting an input source with these buttons, each input must be set on a proper signal form via menu operation (see on pages 25 – 26).

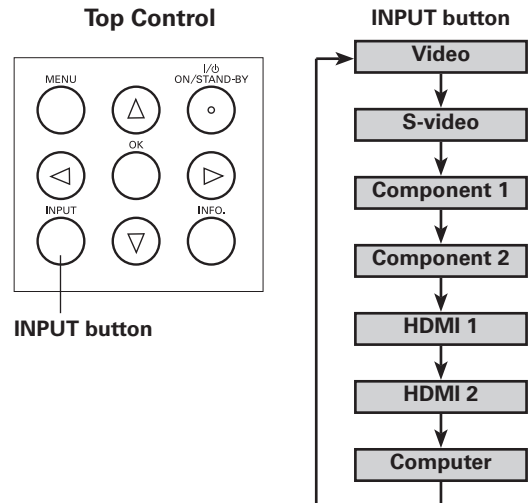

### INPUT buttons on the remote control

Press the VIDEO, S-VIDEO, C1, C2, H1, H2, or PC buttons on the remote control according to the input source.

- VIDEO** When the video signal is connected to the VIDEO jack, press VIDEO.
- S-VIDEO** When the video signal is connected to the S-VIDEO jack, press S-VIDEO.
- C1** When the video signal is connected to the COMPONENT 1 jack, press C1.
- C2** When the video signal is connected to the COMPONENT 2 jack, press C2.
- H1** When the video signal is connected to the HDMI 1 terminal, press H1.
- H2** When the video signal is connected to the HDMI 2 terminal, press H2.
- PC** When the computer signal is connected to the COMPUTER connector, press PC.

✓ **Note:**

- When switching from HDMI1 to HDMI2 or vice versa, the signal may be interrupted for a moment depending on the equipment.

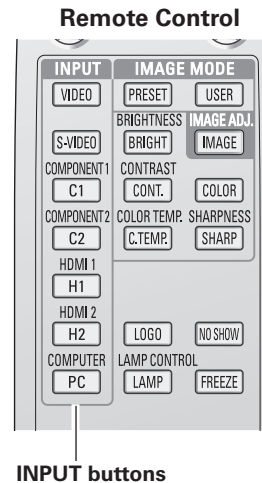



## Menu Operation

- 1** Use the Point ▲▼ buttons to select the Input Menu and press the Point ► or OK buttons to access the submenu items.
- 2** Use the Point ▲▼ buttons to select an input source and press the Point ► or OK buttons. The selected item is check marked.
- 3** When "Video" or "S-video" is selected, press the Point ► button to display the System Menu.
- 4** Use the Point ▲▼ buttons to select the desired system and press the Point ► or OK buttons.
- 5** When "Computer" is selected, press the Point ► button to display the Source Select Menu.
- 6** Use the Point ▲▼ buttons to select the desired source and press the Point ► or OK buttons.

### Input Menu

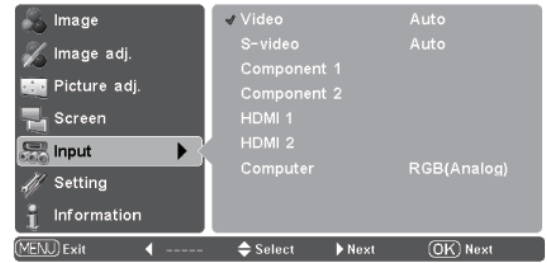

The currently set item is check marked.

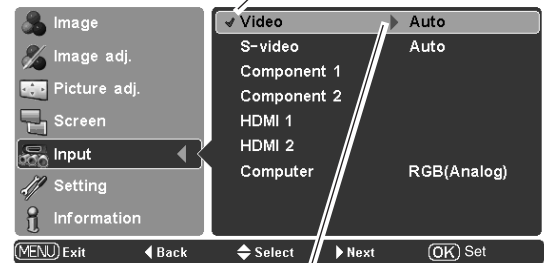

Press the Point ► button to display the System Menu.

## Video or S-Video

When the video signal is connected to the VIDEO or S-VIDEO jacks, select Video or S-video respectively.

### Auto

The projector automatically detects the incoming video system and adjusts itself to optimize its performance. When the video system is PAL-M or PAL-N, select the system manually.

### PAL / SECAM / NTSC / NTSC4.43 / PAL-M / PAL-N

If the projector cannot reproduce a proper video image, select a specific broadcast signal format from among PAL, SECAM, NTSC, NTSC 4.43, PAL-M, and PAL-N.

### System Menu (Video/S-Video)

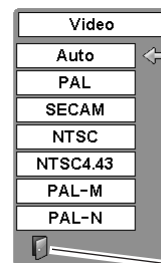

Use the Point ▲▼ buttons to select the desired system and press the Point ► or OK buttons.

### Quit

Exit this menu.

## Component 1 or Component 2

When the video signal is connected to the Y-Pb/Cb-Pr/Cr jacks, select Component 1 or Component 2. The projector automatically detects the incoming video signal and adjusts itself to optimize its performance.

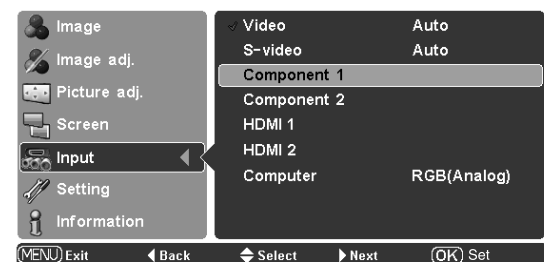

## HDMI 1 or HDMI 2

When the video signal is connected to the HDMI 1 or HDMI 2 terminals, select HDMI 1 or HDMI 2 respectively. The projector automatically detects the incoming video signal and adjusts itself to optimize its performance. If the output signal of video equipment and the input signal of the projector do not match, you might not get an image with the best quality. If the blacks of the picture appears unclear (too dark or too light), try "HDMI 1 setup" or "HDMI 2 setup" in the Setting Menu on page 38.

- ✓ **Note:**
- When switching from HDMI1 to HDMI2 or vice versa, the signal may be interrupted for a moment depending on the equipment.

## Computer

When the signal is connected to the COMPUTER connector, select Computer.

**RGB (Analog)** When the input source is analog coming from a computer connected to the COMPUTER connector, select RGB (Analog).

**RGB (Scart)** When the input terminal is Scart with a DVD player connected to the COMPUTER connector, select RGB (Scart).

The projector automatically tunes to various types of computers based on VGA, SVGA, XGA, WXGA or SXGA with its Multi-scan system and the Auto adj. function (see page 34). If "Computer" is selected as a signal source, the projector automatically detects the signal format and tunes to project a proper image without any additional setting. (The signal formats provided in this projector is shown on page 56.)

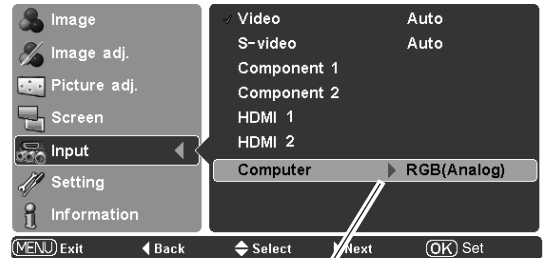
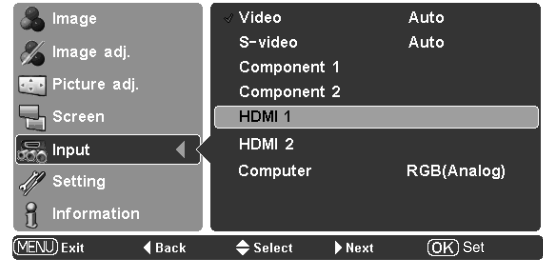

Press the Point ► button to display the Source Select Menu.

### Source Select Menu

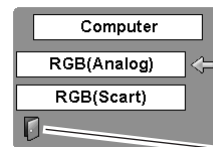

Use the Point ▲▼ buttons to select the desired source and press the Point ► or OK buttons.

**Quit**  
Exit this menu.

# Image

## Image Mode Selection

Image mode selection can be made for each input source.

### Direct Operation

Press the IMAGE MODE buttons (PRESET or USER) on the remote control to select the desired image mode.

Press the PRESET button to select Brilliant cinema, Creative cinema, Pure cinema, Natural, Living, Dynamic, or x.v.Color; press the USER button to select User image 1 – 7.

You can also change the Image mode by pressing the PRESET button or the USER button on the remote control for more than 1 second. When the PRESET button is pressed, the Preset submenu with a check mark on the currently set image mode appears. When the USER button is pressed, the User submenu with a check mark on the currently set image mode appears. Use the Point ▲▼ buttons to select the desired image mode and press the Point ► or OK buttons. The selected item is check marked.

### Menu Operation

- 1 Press the Point ▲▼ buttons to select the Image Menu and press the Point ► or OK buttons to access the submenu items.
- 2 Use the Point ▲▼ buttons to select the desired image mode and press the Point ► or OK buttons. The selected item is check marked.

#### Brilliant cinema

For viewing movies in a brightish room.

#### Creative cinema

For viewing contrasty 3D images in a dark room.

#### Pure cinema

For viewing images with quiet tones of color and less gradation in a dark room.

#### Natural

For viewing images faithfully reproduced without any control by the projector in a dark room.

#### Living

For viewing video sources such as sports or dramas from TV with clear and contrasty images in a bright room.

#### Dynamic

For viewing contrasty images in a bright room.

#### x.v.Color

This mode accepts x.v.Color\*(xvYCC) signal.

#### User image 1 – 7

For displaying user preset image mode in the Image adj. Menu (pp.28 – 33).

#### ✓ Note:

- The Image Menu cannot be operated without an input signal.
- x.v.Color can be selected only when the incoming signal is HDMI 1 or HDMI 2 (p.26).
- Brightness, Contrast, Color, Tint, Color temp., Red, Green, Blue, Gamma, Progressive, Noise reduction, Auto black stretch, Contrast enhancement, Color management, Dynamic gamma, Custom gamma. in the Image mode (p. 28) cannot be adjusted when x.v.Color is selected.

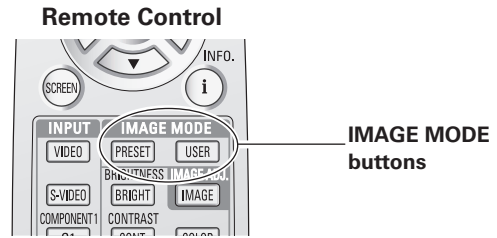

#### PRESET button

Brilliant cinema → Creative cinema → Pure cinema → Natural → Living → Dynamic → x.v.Color → Brilliant cinema → ...

#### USER button

User image 1 → User image 2 → User image 3 → User image 4 → User image 5 → User image 6 → User image 7 → User image 1 → ...

#### Image Menu

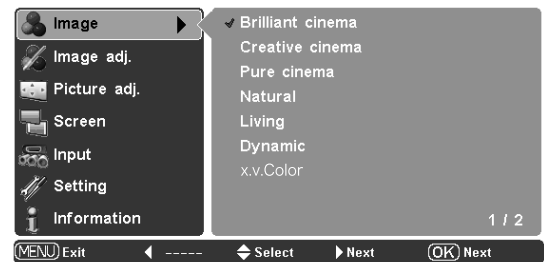

The selected image mode.

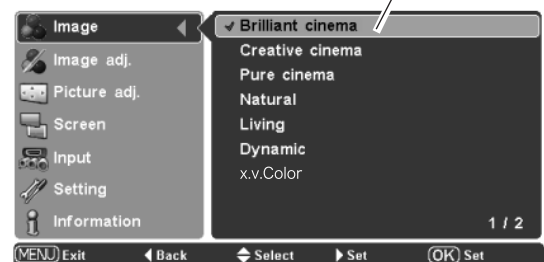

Press the Point ▼ button to move on to the next items.



\* "x.v.Color" is a trademark of Sony Corporation.

# Image Adjustment

## Image Mode Adjustment

Image mode can be adjusted for each input source and the adjustment is kept until the projector is turned off or the image mode is changed.

### Direct Operation

Press the IMAGE ADJ. button on the remote control to display the adjustment bar of Image adj. Menu items one at a time and directly adjust the selected item.

Use the Point ▲▼ buttons to select the desired item and the Point ◀▶ buttons to adjust the setting. Press the MENU button after adjusting.

If you press the OK button after adjusting each item, it will enter the main menu.

### Menu Operation

- 1 Press the Point ▲▼ buttons to select the Image adj. Menu and press the Point ▶ or OK buttons to access the submenu items.
- 2 Use the Point ▲▼ buttons to select the desired item and press the Point ▶ or OK buttons to access the selected item. The adjustment bar is displayed.
- 3 Use the Point ◀▶ buttons to adjust the setting values and press the OK button.

### Brightness

Press the Point ◀ button to decrease the brightness; press the Point ▶ button to increase the brightness (from -31 to +31).

### Contrast

Press the Point ◀ button to decrease the contrast; press the Point ▶ button to increase the contrast (from -31 to +31).

### Color

Press the Point ◀ button to decrease the intensity of the color; press the Point ▶ button to increase the intensity of the color (from -31 to +31).

### Tint

Use the Point ◀▶ buttons to adjust the tint value to obtain a proper color balance (from -31 to +31).

### Color temp.

Use the Point ◀▶ buttons to select the desired Color temp. level (High2, High1, Default, Low1, or Low2). Default is based on the currently set image mode (p.27).

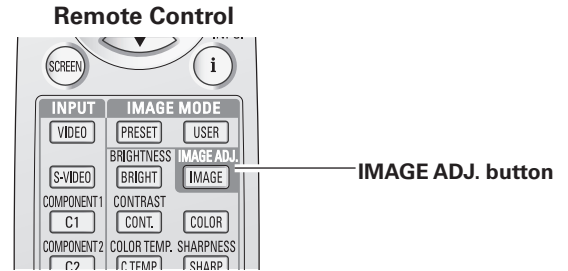

### When Advanced menu is set to Off.

Brightness → Contrast → Color → Tint → Color temp. → Red → Green → Blue → Sharpness → Lamp control → Gamma → Progressive → Noise reduction → Brightness → ...

### When Advanced menu is set to On.

Brightness → Contrast → Color → Tint → Color temp. → Red → Green → Blue → Sharpness → Lamp control → Gamma → Progressive → Noise reduction → Iris mode → Iris range → Auto black stretch → Contrast enhancement → Transient improvement → Color management → Smooth motion → 5:5 pull down → Dynamic gamma → 3D-Y/C → Custom gamma → Brightness → ...

### ✓ Note:

- 3D-Y/C may not appear depending on the input signal.

### Image adj. Menu

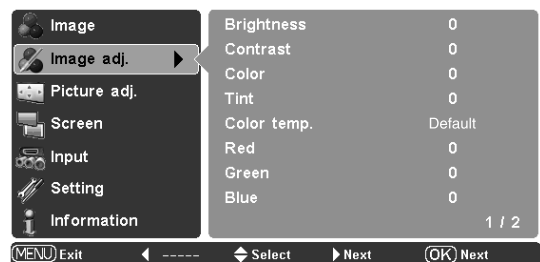

### ✓ Note:

- Above image is an example of when the Image mode is set to "Natural." Each value varies depending on the selected Image mode (p.27).



Go on to the next page....

### ✓ Note:

- Tint cannot be selected when the video system is PAL, SECAM, PAL-M, or PAL-N in Video input or S-video input.
- The Image adj. Menu cannot be operated without an input signal.

## White balance (Red)

Press the Point ◀ button to lighten red tone; press the Point ▶ button to deepen red tone (from -31 to +31).

## White balance (Green)

Press the Point ◀ button to lighten green tone; press the Point ▶ button to deepen green tone (from -31 to +31).

## White balance (Blue)





Press the Point ◀ button to lighten blue tone; press the Point ▶ button to deepen blue tone (from -31 to +31).

## Sharpness

Press the Point ◀ button to decrease the sharpness of the image; press the Point ▶ button to increase the sharpness of the image (from -7 to +7).

## Lamp control

This function allows you to change the brightness of the screen. Use the Point ◀▶ buttons to select the desired lamp mode. You can also select the lamp mode by pressing the LAMP CONTROL button on the remote control.

-  Normal . . . . . Normal brightness.
-  Auto 1 . . . . . The brightness according to the input signal. (Lower sound than Auto 2.)
-  Auto 2 . . . . . The brightness according to the input signal.
-  Eco. . . . . . . . . . . Lower brightness reduces the lamp power consumption.

The lamp mode is automatically switched to "Eco" under no signal input.

## Gamma

Use the Point ◀▶ buttons to adjust the gamma value to obtain a better balance of contrast (from -7 to +7).

## Progressive

An interlaced video signal can be displayed in progressive. Use the Point ◀▶ buttons to select the desired options.

- Off . . . . . Disabled.
- Video . . . . . For moving pictures.
- Auto . . . . . Auto adjustment according to the video signal or film signal (3-2 and 2-2 pulldown video sources.)

## Noise reduction

Noise interference on the screen can be reduced. Press the Point ◀▶ buttons to change the noise reduction mode.

- Off . . . . . Noise reduction mode is "Off"
- On . . . . . Noise reduction mode is "On"

### ✓ Note:

- If any one of the White balance (Red, Green, or Blue) are adjusted, the Color temp. level changes to "User"
- Progressive cannot be selected with the computer input and when the video signal format is 480p, 575p, 720p, or 1080p.
- Noise reduction cannot be selected with the computer input and when the video signal format is 1080p.

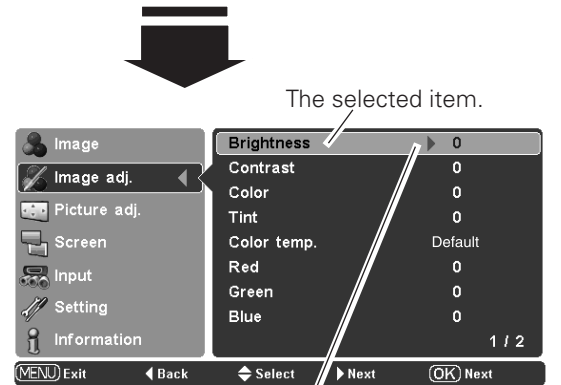

Press the Point ▶ or OK buttons to access the selected item. The adjustment bar is displayed.



Use the Point ◀▶ buttons to adjust the setting values and press the OK button. If you press the Point ▼ button, the next item can be selected.

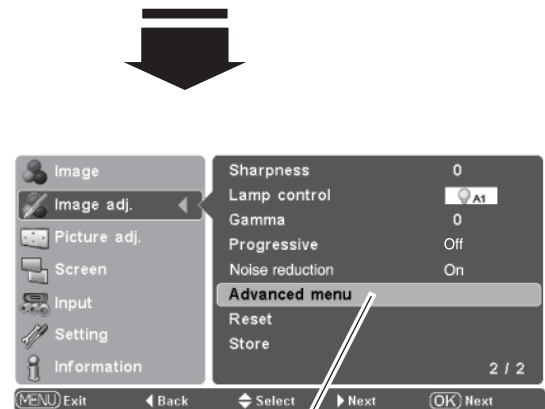
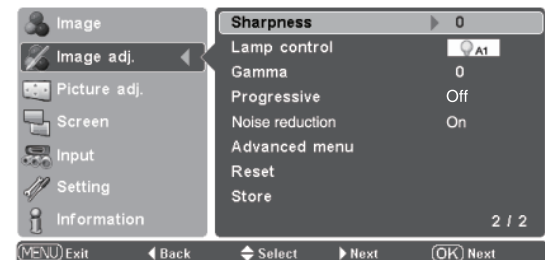

Press the Point ▶ or OK buttons to display the Advanced menu.

Go on to the next page....

# Image Adjustment

## Advanced menu

This function can be selected only when Advanced menu in the Setting Menu (see page 37) is set to "On." You can adjust the following items through this function.

### Iris mode

Adjust the lamp aperture. Select from the following options:

- Mode 1 . . . Brightness is prioritized over contrast
- Mode 2 . . . Contrast is prioritized over brightness
- Fixed . . . . Fixed lamp aperture set in the Iris range

### Iris range

Adjust the upper limit of the lamp aperture (from -63 to 0).

#### ✓ Note:

- Value changes depending on the selected image mode.

### Auto black stretch

Enhance blacks in bright areas of an image. It can be set in 4 steps (Off/Low/Mid/High).

### Contrast enhancement

Adjust the contrast in bright scenes in 4 steps (Off/Low/Mid/High).

### Transient improvement

Adjust the sharpness of image outlines in 4 steps (Off/Low/Mid/High).

### Color management

Adjust the level, phase, and gamma of any color. You can store up to eight (8) color management data. For details, see "COLOR MANAGEMENT" on page 32.

### Smooth motion

Select one of the following options to get smoother images:

- Off . . . . . Basic correction
- Low . . . . . Small correction
- Mid . . . . . Medium correction
- High . . . . . Large correction

### 5:5 pull down

Select the 5:5 pull down mode when the film source is detected.

- Off . . . . . 5:5 pull down mode is "Off"
- Auto . . . . . 5:5 pull down mode is "On"

#### ✓ Note:

- 5:5 pull down cannot be operated when HDMI 1080/24p or the computer signal is selected.
- 5:5 pull down can be selected only when Progressive is set to Video or Auto (p.29).

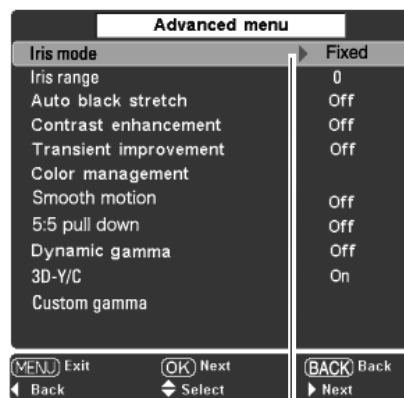

Press the Point ► or OK buttons to access the selected item. The adjustment bar is displayed.



Use the Point ◀▶ buttons to adjust the setting values and press the OK button. If you press the Point ▼ button, the next item can be selected.

## Dynamic gamma

Set the level for Dynamic gamma correction. Select from the following options:

- Off . . . . . Disable dynamic gamma correction
- Low . . . . . Small correction
- Mid . . . . . Medium correction
- High . . . . . Large correction

**✓ Note:**

- One of the above options are displayed depending on the selected image mode.

## 3D-Y/C

Optimally separates the color and brightness signal to reduce cross-color and dot interference. Press the Point ◀▶ buttons to change the 3D-Y/C mode.

- Off . . . . . 3D-Y/C mode is "Off"
- On . . . . . 3D-Y/C mode is "On"

**✓ Note:**

- 3D-Y/C may not appear depending on the input signal.

## Custom gamma

Adjust R, G, B to get the desired balance of contrast.

Select Custom gamma in the Advanced menu and press the Point ▶ or OK buttons. The custom gamma window appears. Use the Point ▲▼ buttons to choose the desired item from Gamma R, Gamma G, and Gamma B and then press the Point ▶ or OK buttons to display the gamma adjustment window. The colored gamma pointer indicates where you are making an adjustment. The white gamma pointer indicates where the value is set.

**✓ Note:**

- Default position of the gamma pointer is located in the center of the gamma bar. Once you make an adjustment, the gamma pointer remains where the adjustment is made.
- The values are set to 0 when no adjustment is made.

Use the Point ◀▶ buttons to move the colored gamma pointer between the gamma bars (9 bars) to select a desired gamma bar. Use the Point ▲▼ buttons to move the colored gamma pointer within the gamma bar (from -15 to +15 except for the left and right end bars) to adjust the gamma value. The adjustment you make reflects on the screen as you change the adjustment value.

**✓ Note:**

- When the Point ▶ button is pressed at the right end of the gamma bar, the next gamma color adjustment window appears (R → G → B → R → ...). When the Point ◀ button is pressed at the left end of the gamma bar, the next gamma color adjustment window appears (R → B → G → R → ...).



Press the Point ▶ or OK buttons to access the selected item. The custom gamma window is displayed.

## CUSTOM GAMMA

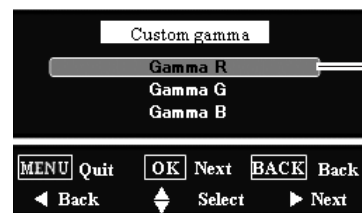

Use the Point ▲▼ buttons to select the desired item and press the Point ▶ or OK buttons. The gamma adjustment window is displayed.

## GAMMA ADJUSTMENT

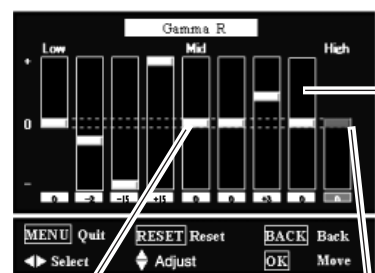

White gamma pointer    Colored gamma pointer



When the Point ▶ button is pressed at the right end of the gamma bar in Gamma R, the Gamma G with the colored gamma pointer on the left end gamma bar appears.

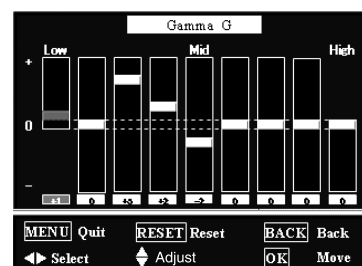

## COLOR MANAGEMENT

### COLOR MANAGEMENT LIST

Select Color management in the Advanced menu and then press the Point **▶** or OK buttons. The COLOR MANAGEMENT LIST appears. You can store up to eight (8) color management data in the list.

In the COLOR MANAGEMENT LIST, the adjusted color data are check marked reflecting the changes in the image. You can choose whether to apply the data in the list to the image.

Clear the check mark if you do not want to apply the data; select the check mark and then press the OK button. The check mark disappears.

If you want to readjust the color, select a color data box in the list and press the OK button. The COLOR SELECTION window appears and you can readjust the color. See below for color selection.

If you want to delete a particular data in the list, select the DEL box and then press the OK button. A confirmation box appears. Select [Yes] and then press the OK button.

Press the OK button when selecting the following items.

- ALL DEL . . . . . Delete all the data in the list. Press the OK button and a confirmation box appears. Select [Yes] and press the OK button.
- COLOR M. . . . . Go to COLOR SELECTION.
- EXIT . . . . . Exit the Color management mode and return to the Advanced menu. To store the adjusted data, see "Store" on the next page.

Press the MENU button when you want to return to the Advanced menu.

### COLOR SELECTION

Press the OK button when "COLOR M." in the COLOR MANAGEMENT LIST is selected. The COLOR MANAGEMENT LIST disappears and the Color management pointer appears.

Use the Point **▲▼◀▶** buttons to move the pointer to a spot where you want to adjust the color and then press the OK button. The image freezes and the COLOR SELECTION window appears. (Note that when certain colors are chosen, an exclamation mark is displayed indicating that these colors are not adjustable.)

Use the Point **▲▼** buttons to select COLOR LEVEL, COLOR PHASE, or GAMMA and the Point **◀▶** buttons to adjust them. While adjusting, the changes are reflected in the image accordingly. If you press the MENU button while operating the color selection, the Color management pointer will be reset.

After adjusting, press the OK button to go to the COLOR MANAGEMENT LIST.

### COLOR MANAGEMENT LIST

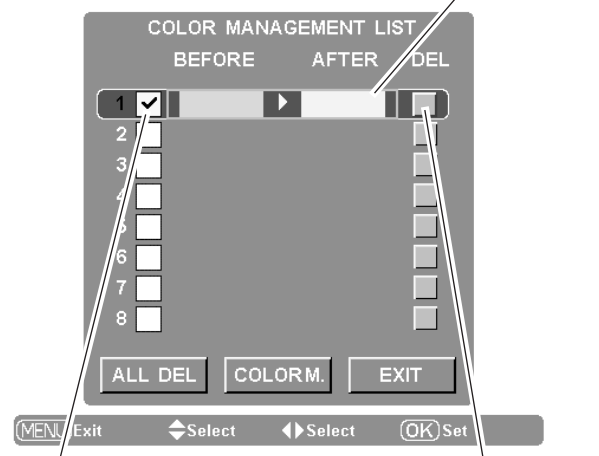

Clear the check mark if you do not want to apply this adjusted color data to the projected image.

Select the DEL box if you want to delete the adjusted data. A confirmation box appears.



Select [Yes] to delete the selected color data.

### COLOR SELECTION

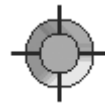

#### Color management pointer

Use the Point **▲▼◀▶** buttons to move the pointer to a spot where you want to adjust the color and then press the OK button. The COLOR SELECTION window appears.



After adjusting COLOR LEVEL, COLOR PHASE, and GAMMA, press the OK button.

Go to the COLOR MANAGEMENT LIST.

To store the adjusted data, exit the Color management mode and go to "Store" in the Image adj. Menu (see page 33).



## Reset

To reset the adjusted data, select Reset and press the Point ► or OK buttons. A confirmation box appears. Select [Yes] and then press the OK button. All adjustments return to their previous figures. You can also reset the adjusted data by pressing the RESET button on the remote control.

## Store

To store the adjusted data, select Store and press the Point ► or OK buttons. The User Image Mode Menu appears. Use the Point ▲▼ buttons to choose one of the seven (7) user image modes and press the Point ► or OK buttons. A confirmation box appears. Select [Yes] and then press the OK button.

To exit the User Image Mode Menu, go to the Quit icon and press the Point ► or OK buttons. The stored data can be called up by selecting "User image 1 – 7" in the Image Mode Selection on page 27.

### ✓ Note:

- If you change the image mode (see page 27) or turn off the POWER without storing adjusted settings, all the adjusted settings will be reset.
- When resetting, the adjusted data in Advanced menu will be reset whether or not Advanced menu in the Setting Menu is "On." See page 37.

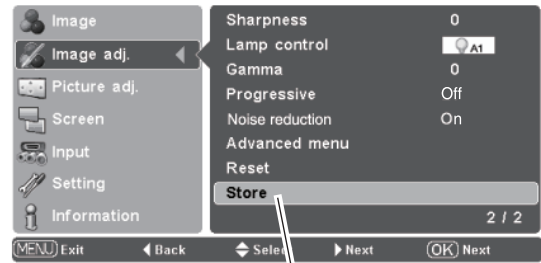

Press the Point ► or OK buttons to store the adjusted data. The User Image Mode Menu appears.



### Quit

Choose one of the seven (7) user image modes with the Point ▲▼ buttons and press the Point ► or OK buttons. The confirmation box appears.

Press the Point ► or OK buttons to exit the User Image Mode Menu.

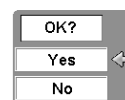

Select [Yes] and then press the OK button.

# Picture Adjustment

## Picture Position and Screen Adjustment

Some input source employ special signal formats which may not be tuned by the auto-tuning system of this projector. Picture Adjustment enables you to precisely adjust several parameters manually to match those signal formats. The parameters manually adjusted is stored for every input.

- 1 Press the Point ▲▼ buttons to select the Picture adj. Menu and press the Point ► or OK buttons to access the submenu items.
- 2 Use the Point ▲▼ buttons to select the desired item and press the Point ► or OK buttons to access the selected item. The adjustment bar is displayed.
- 3 Use the Point ◀▶ buttons to adjust the setting values and press the OK button.

### Overscan

Use the Point ◀▶ buttons to adjust the overscan area. It works only to decrease the overscanned portion of the screen (from 0 to +10).

### Horizontal

Use the Point ◀▶ buttons to adjust the horizontal picture position (from -100 to +100).

### Vertical

Use the Point ◀▶ buttons to adjust the vertical picture position (from -100 to +100).

### Auto adj.

When the input signal is from computers, select Auto adj. and press the Point ► or OK buttons so that it automatically adjust Fine sync, Total dots, and Horizontal and Vertical positions to conform to your computer.

### Fine sync

Use the Point ◀▶ buttons to adjust the value, eliminating a flicker from the image displayed (from 0 to +31).

### Total dots

Use the Point ◀▶ buttons to adjust the number of total dots in one horizontal period to match your PC image (from -100 to +100).

### ✓ Note:

- Overscan can be selected with the video input only.
- When the digital signal is selected and the image noise appears on the edge of the screen, use the Overscan to make adjustment.
- The adjusting range for the Horizontal and Vertical positions, and Total dots differs depending on the input signal. When the video signal format is 480i or 575i, the adjusting range for the Horizontal position will be from -8 to +8.
- The Auto adj. function cannot be operated with the video input, some incompatible computer input and digital signals.
- Fine sync and Total dots cannot be operated with some incompatible computer input and digital signals.
- The Picture adj. Menu cannot be operated without an input signal.
- When the adjustment exceeds the signal range of Horizontal and Vertical positions, and Total dots, the projected image may be distorted.

### Picture adj. Menu

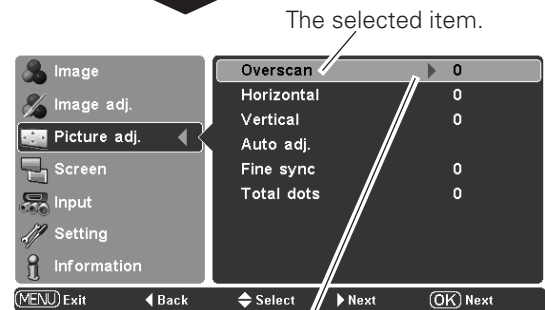
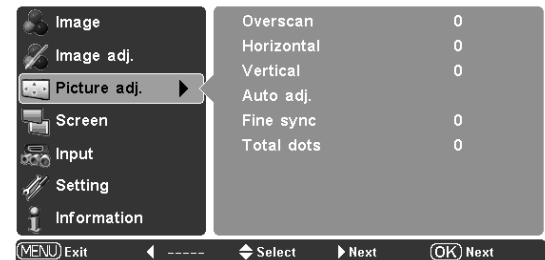

Press the Point ► or OK buttons to access the selected item. The adjustment bar is displayed.



Use the Point ◀▶ buttons to adjust the setting values and press the OK button to return to the submenu.

If you press the Point ▼ button, the next item can be selected.

## Screen Size Adjustment

This projector has the picture screen resize function which enables you to customize the image size.

### Direct Operation

Press the SCREEN button on the remote control to select a screen size from among Full, Zoom, Normal, Natural wide, and Anamorphic.

### Menu Operation

- 1 Press the Point ▲▼ buttons to select the Screen Menu and press the Point ► or OK buttons to access the submenu items.
- 2 Use the Point ▲▼ buttons to select the desired screen size and press the Point ► or OK buttons. The selected item is check marked.

#### Full

Fit the image to the screen by expanding the width of the image uniformly. This function can be used to project a squeezed video signal at the wide video aspect ratio of 16:9.

#### Zoom

Fit the image to the screen size (16:9 aspect ratio) by expanding the width and height of the image uniformly.

With the input signals other than 1080p, 1080i or 720p, this function is used to project a letterboxed picture (the 4:3 aspect ratio picture with a black bar at the top and bottom) at the wide video aspect ratio of 16:9.

When the input signal is 1080p, 1080i or 720p, a letterboxed picture in a 16:9 screen can be projected by expanding at the wide video aspect ratio of 16:9.

In the Zoom mode, you can also adjust the display range with the vertical adj. function. See "Vertical adj." on the next page for details.

#### Normal

Fit the image to the center of the screen at the normal video aspect ratio of 4:3.

#### Natural wide

Modify the image to fit the screen size by stretching the image to make it look natural.

When the video signal format is 480i, 575i, 480p, or 575p, the 4:3 aspect ratio image is modified to fit the screen size (16:9 aspect ratio.)

When the video signal format is 1080p, 1080i, or 720p, the 4:3 aspect ratio image in 16:9 signals is modified to fit the screen size (16:9 aspect ratio.)

#### Anamorphic

Modify the 2.35:1 aspect ratio image in 16:9 signals to fit the screen size by stretching the image in a vertical direction. This function can be selected only when 1080i, 1080p, or 720p signals are selected.

In the Anamorphic mode, you can also adjust the display range with the vertical adj. function. See "Vertical adj." on the next page for details.

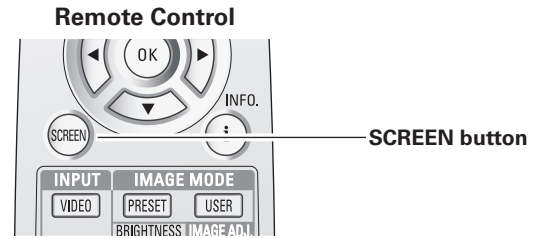

Full → Zoom → Normal → Natural wide → Anamorphic → Full → ....

### Screen Menu

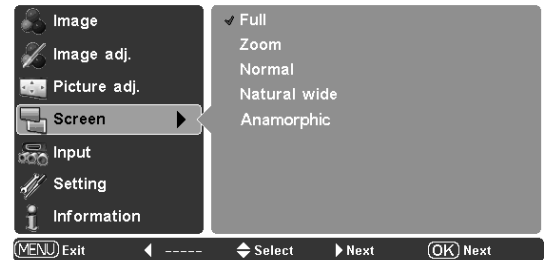

The selected screen size.

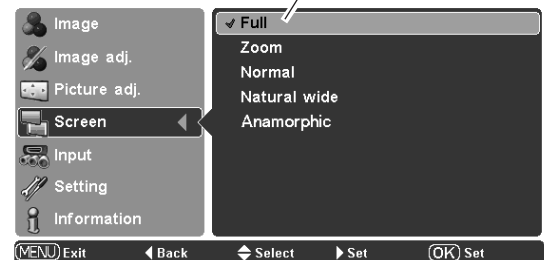

#### ✓ Note:

- When the video signal format is 480i, 575i, 480p, or 575p, the Screen Menu cannot be selected except for Full, Zoom, Normal, Natural wide.
- When the video signal format is 1080p, 1080i, or 720p, the Screen Menu cannot be selected except for Full, Zoom, Normal wide, Anamorphic.
- When Normal is selected with a computer input, the image is projected at the inputted resolution.
- This projector cannot display any resolution higher than 1920 x 1080. If your computer's resolution is higher than that, lower the resolution before connecting to the projector.
- The image data other than the 1920 x 1080 resolution is modified to fit the screen size in initial mode.

## Vertical adj.

When it is in the Zoom or Anamorphic mode, press the Point ▲▼ buttons to display the Vertical adj. dialog box. Use the Point ▲▼ buttons to adjust the vertical position. The adjusting range differs depending on the input signal.

The adjusted value is only effective in the Zoom and Anamorphic mode. When the Reset button is pressed while the Vertical adj. dialog box is displayed, the adjusted value returns to 0.

The Vertical adj. dialog box cannot be displayed when the On-Screen Menu is on.

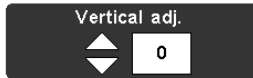

### ✓ Note:

- The Screen Menu cannot be operated without an input signal.
- The Vertical adj. function is operated only when Zoom or Anamorphic is selected.

## List of the projected images \* Images in the chart below are the examples and differ from the actual images.

	4:3 Composite / S-video/ 480i / 480p / 575i / 575p	4:3 (Squeeze) Composite / S-video/ 480i / 480p / 575i / 575p	4:3 Cinesco L.B(Letterbox)	4:3 Vista (16:9) L.B(Letterbox)	16:9 720p / 1080i / 1080p	16:9 720p / 1080i / 1080p (4:3 display)	16:9 720p / 1080i / 1080p (21:9 Cinesco display)
Original signal (image)							
Full							
Zoom							
Normal							
Natural wide							
Anamorphic							

Screen: Look dark in the actual setting.

# Setting

## Setting

The Setting Menu allows you to set up other various functions described below.

- 1** Press the Point ▲▼ buttons to select the Setting Menu and press the Point ► or OK buttons to access the submenu items.
- 2** Use the Point ▲▼ buttons to select the desired item and press the Point ► or OK buttons to access the selected item.
- 3** Use the Point ▲▼ or OK buttons to adjust the setting.

### Language

The language used in the On-Screen Menu is available in English, German, French, Italian, Spanish, Portuguese, Dutch, Swedish, Finnish, Polish, Hungarian, Romanian, Russian, Chinese, Korean, or Japanese.

### Advanced menu

When this function is "On," the Advanced menu in the Image Mode Adjustment can be selected. Press the Point ► or OK buttons to switch On/Off. See "Advanced menu" on pages 30 - 31 for details.

### Menu position

This function is used to change the position of the On-Screen Menu. Select Menu position and press the Point ► or OK buttons. The Menu position screen appears. Use the Point ▲▼◀▶ buttons to select the desired position and press the OK button.

### Ceiling

When this function is set to "On," the picture is top/bottom and left/right reversed. This function is used to project the image from a ceiling-mounted projector. Press the Point ► or OK buttons to switch On/Off.

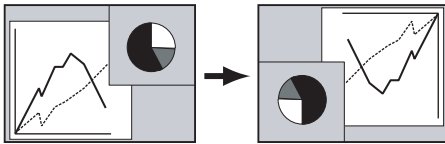

### Rear

When this function is set to "On," the picture is left/right reversed. This function is used to project the image to a rear projection screen. Press the Point ► or OK buttons to switch On/Off.

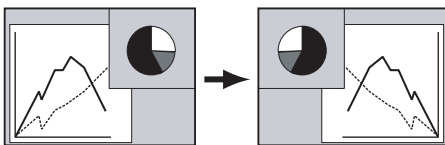

### Setting Menu

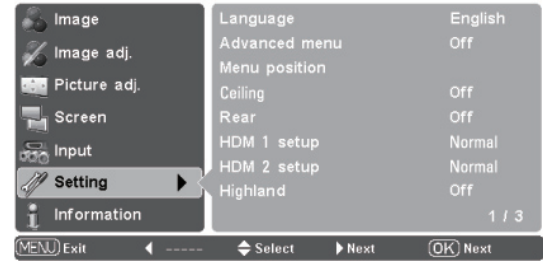

### Language

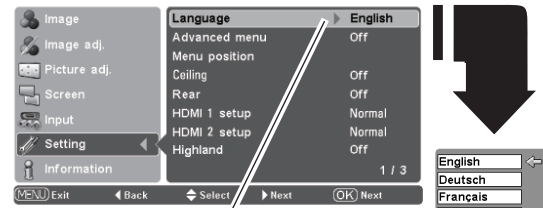

Press the Point ► or OK buttons to display the Language Menu.

Choose a language and press the Point ► or OK buttons. The pointer moves to this icon. Press the Point ► or OK buttons again to activate it.

### Menu position

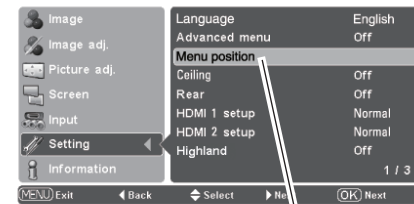

Select Menu position and press the Point ► or OK buttons. The Menu position screen appears.

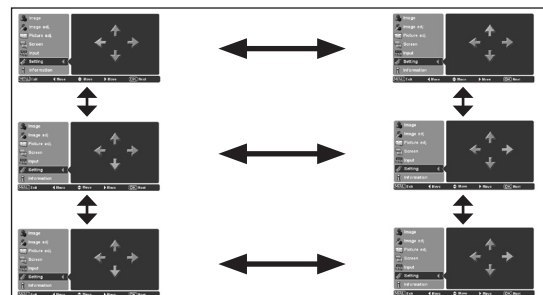

## HDMI 1 setup/ HDMI 2 setup

Select Normal or Enhanced according to the output signal of video equipment. Press the Point ► or OK buttons to switch between each option.

Normal . . . . When the output of video equipment is set to "STANDARD."

Enhanced . . . . When the output of video equipment is set to "ENHANCED."

The names for the output setting of video equipment vary from equipment to equipment. For details, refer to the owner's manual of video equipment.

## Highland

When using the projector in high altitudes (about 1,200 meters or more above the sea level), set this function "On." Press the Point ► or OK buttons to switch On/Off.

### ✓ Note:

- Failure to set this mode properly may affect the projector life.

## Background

Select the background screen for when no input signal is detected. Press the Point ► or OK buttons to switch between each option.

Blue . . . . Project a blue background

Logo . . . . Project an image selected in the Logo setting.

Black. . . . Project a black background

### ✓ Note:

- When the Logo setting (see page 40) is set to "Off" with the "Logo" background, the Background setting will be switched to "Blue."

## HDMI 1 setup

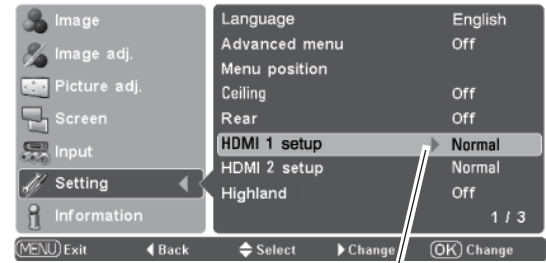

Press the Point ► or OK buttons to select Normal or Enhanced according to the output signal of video equipment.

## Background

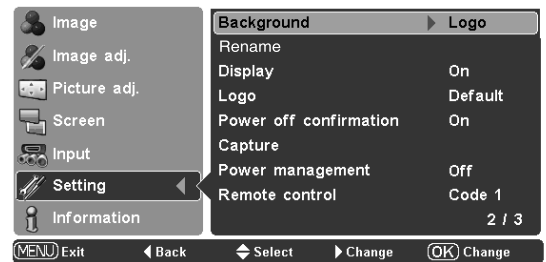

**Rename**

This function is used to change the name of the Input or the User image. Select Rename and press the Point ▶ or OK buttons. The Rename window appears. Use the Point ▲▼ buttons to choose either Input or User image and then press the Point ▶ or OK buttons to display the rename item selection window.

Use the Point ▲▼ buttons to choose a desired item and press the Point ▶ button to display on-screen keyboard.

✔ **Note:**

- Custom is blank and check mark cannot be placed when an item is not renamed

Use the Point ▲▼◀▶ buttons to select a desired character or function. Left-arrow key moves the cursor one position backward or deletes the preceding character. Convert key converts between uppercase and lowercase letters. The selected key will be framed red. Press the OK button to execute your selection. Press the RESET button to clear your entry.

To complete the naming entry, press the MENU button. The confirmation dialog box appears. Select [Yes] and press the OK button, then the custom name is registered. The rename item selection window with a newly registered name under custom field appears.

To cancel the naming entry, press the MENU button. The confirmation dialog box appears. Select [No] and press the OK button to continue. Another confirmation dialog box appears, and select [Yes] to cancel your entry.

To return to the on-screen keyboard to change the custom name, press the MENU button. The confirmation dialog box appears. Select [No] and press the OK button to continue. Another confirmation dialog box appears, and select [No]. The on-screen keyboard with a newly entered custom name in the text field appears. You can correct or change the custom name.

✔ **Note:**

- You cannot type characters when the length of the name exceeds the text field limit. Maximum length of the character you can type varies depending on the item or the type of characters.
- Custom name cannot be registered when the text field is filled with spaces and no characters are entered.

**Rename**

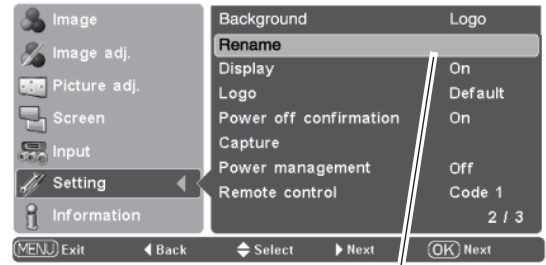

Select Rename and press the Point ▶ or OK buttons. The Rename window appears.

**RENAME WINDOW**

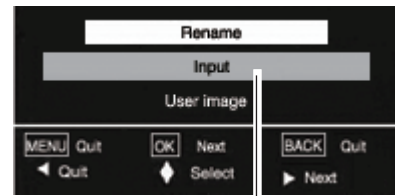

Use the Point ▲▼ buttons to select Input or User image and Press the Point ▶ or OK buttons to display the rename item selection window.

**RENAME ITEM SELECTION WINDOW**

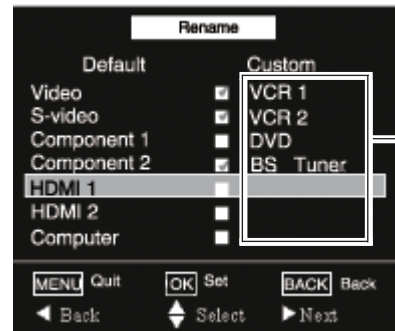

**ON-SCREEN KEYBOARD**

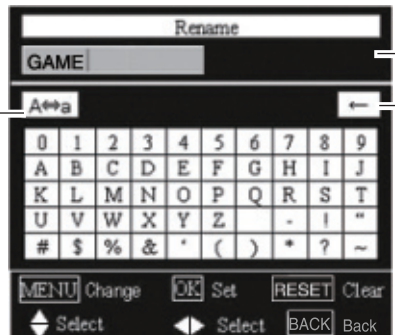

Text field  
Left arrow key

Convert key

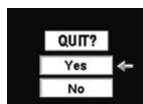
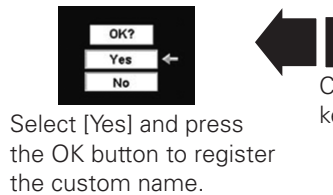

Select [Yes] and press the OK button to cancel the naming entry.

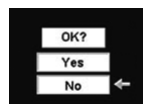

Select [No] and press the OK button, then another confirmation box appears.

To complete the naming entry, press the MENU button. The confirmation dialog box appears.

## Display

This function decides whether to display the On-Screen displays. Press the Point ► or OK buttons to switch between each option.

- On . . . . . Show all the On-Screen displays. Use this function when you want to project images after the lamp becomes bright enough. The factory default setting is in this option.
- Countdown Off. . Show the input image instead of the countdown when turning on the projector. Use this function when you want to project the image as early as possible even when the lamp is not bright enough.
- Off . . . . . Hide the On-Screen Displays except;
  - On-Screen Menu
  - "Power off?"
  - "No signal" for Power management (p.41)
  - "Please wait ..."
  - Color management operation screen (p.32)

## Logo

This function decides on the starting-up display from among the following options. Press the Point ► or OK buttons to switch between each option.

- User . . . . . Show the Image you captured.
- Default . . . Show the factory-set logo.
- Off . . . . . Show the Countdown display only.

### ✓ Note:

- "User" option cannot be selected without capturing an image.

## Power off confirmation

When this function is set to "On," a confirmation dialog box with "Power off?" is displayed when turning off the projector (p.19). Press the Point ► or OK buttons to switch On/Off.

## Capture

This function enables you to capture an image being projected to use it for the starting-up display or interval of presentations. Select Capture and press the Point ► or OK buttons. The confirmation box appears and select [Yes] to capture the projected image. The captured image will be displayed the next time the projector is turned on.

To cancel the Capture function, select [No].

### ✓ Note:

- A signal from a computer can be captured up to XGA (1024 x 768).
- The image that has been adjusted in the Image adj. Menu will not be reflected even if it is captured.
- If the Capture function fails to capture an image or stops capturing halfway, the On-Screen Menu returns to the Capture item.
- The Capture function cannot be operated with unsupported signals.
- When starting to capture a new image, the previously stored image is cleared even if you cancel the capturing.

## Capture

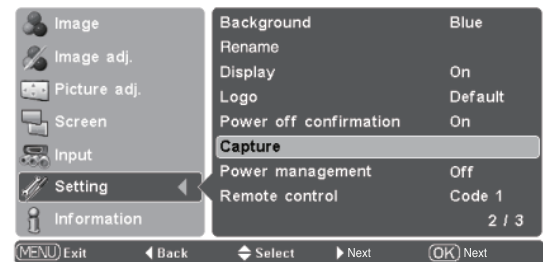

Select [Yes] to capture the projected image.

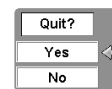

Select [Yes] to stop capturing.



## Power management

For reducing power consumption as well as maintaining the lamp life, the Power management function turns off the projection lamp when the projector is not used for a certain period.

When this function is "On" and if the input signal is interrupted and no button is pressed for more than 30 seconds, the timer display with "No signal" appears on the screen. It starts the countdown until the lamp is turned off. The countdown time is set to five (5) minutes.

When the countdown time has elapsed, the lamp is turned off to cool itself down. The POWER indicator is blinking red during the cooling-off period. When the lamp has been fully cooled down, the POWER indicator changes to green blinking. In this condition, the projection lamp can be turned on when the input signal is reconnected or any button on the top control or remote control is pressed.

Press the Point ► or OK buttons to switch On/Off.

## Remote control

Two different remote control codes are assigned to this projector: the factory-set code (Code 1) and the secondary code (Code 2). This switching function prevents interference from other remote controls when several projectors or video equipment next to each other are used at the same time.

When operating the projector in Code 2, the code for both the projector and the remote control must be switched to Code 2.

### To change the code of the projector:

Press the Point ► or OK buttons to switch between Code 1 and Code 2.

### To change the code of the remote control:

Press and hold both the MENU and IMAGE ADJ. button on the remote control for more than 5 seconds to switch between Code 1 and Code 2.

After changing the code, make sure the remote control operates properly.

#### ✓ Note:

- When the batteries of the remote control are replaced, the remote control code automatically returns to the initial code (Code 1).

## Shutter demo

Press the Point ► or OK buttons to start Shutter demo. The automatic slide shutter closes once with the lamp being turned on and opens up again. This is used for checking the operation of the automatic slide shutter.

#### ✓ Note:

- The Shutter demo function cannot be operated continuously. Once you started, it cannot be selected again for about five seconds.

## Power management

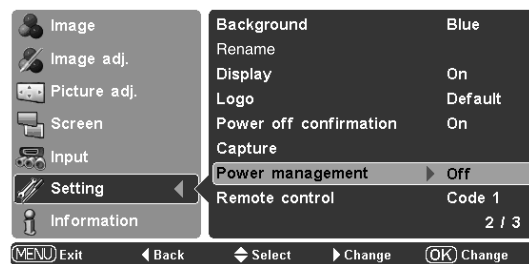

## Remote control

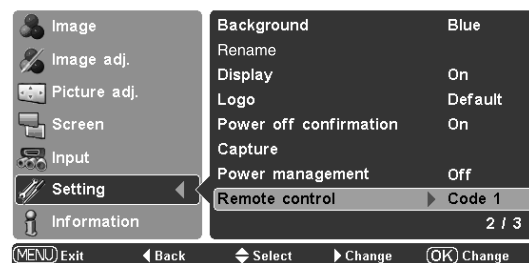

## Shutter demo

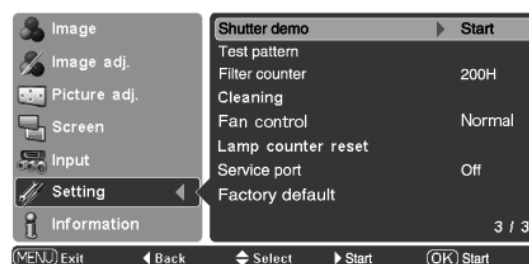

## Test pattern

A test pattern for zoom and focus adjustment is available for use when setting up the projector.

## Filter counter

This function is used to set a frequency for the filter cleaning.

When the projector reached a specified time between cleanings, a Filter warning icon appears on the screen, notifying the cleaning is necessary.

Use the Point ► button to select the desired timer [Off/ 50H/ 100H/ 200H/ 300H/ 400H/ 500H] and press the OK button. After cleaning the filter, be sure to select [Reset] and set the timer. The Filter warning icon will not turn off until the filter counter is reset.

For details about resetting the timer, refer to "Resetting the Filter Counter" on page 48.

## Cleaning

This function is used to clean the inside of the projector. Using a blower at the same time is more effective. See page 46.

Press the Point ► or OK buttons, then the projected image is blacked out temporarily regardless of whether or not an input source is selected.

To cancel the cleaning function, set the projector back into the right position, then press any other button during cleaning operations.

### ✓ Note:

- The Power management function cannot be operated during cleaning.

## Fan control

Choose the running speed of cooling fans from the following options according to the environment where there is a drastic elevation of room temperature while the projector is being used.

Normal..... Normal speed.

Mode 1 ..... Faster than Normal mode. Use this mode when you want to increase the cooling effect when operating the projector in the environment, where there is a drastic elevation of room temperature.

Mode 2 ..... Faster than Mode 1 mode. Use this mode when you want to increase the cooling effect when operating the projector in the environment, where there is a more drastic elevation of room temperature.

### ✓ Note:

- Fan noise becomes louder in Mode 1 and Mode 2.

## Lamp counter reset

This function resets the lamp replacement counter. When replacing the projection lamp, reset the lamp replacement counter with this function. See page 50 for operation.

## Service port

For technician use ONLY. Set this function to Off.

## Factory default

This function restores all setting values except for the user's logo, the filter counter and the lamp time to the factory default settings.

## Filter counter

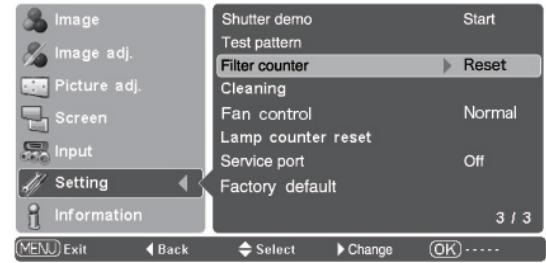

Use the Point ► button to select the timer from (Reset/Off/ 50H/ 100H/ 200H/ 300H/ 400H/ 500H) depending on the use environment.

## Filter warning

Filter warning icon appears on the screen at a set time.

### ✓ Note:

- The Filter warning icon will not appear when the Display function is set to "Off" (p.40), during "Freeze" (p.23), "No show" (p.23), "Color management" (p.32), "Test pattern" (p.42), "Rename" (p.39), "Custom gamma" (p.31), or "Cleaning" (p.42).

## Factory default

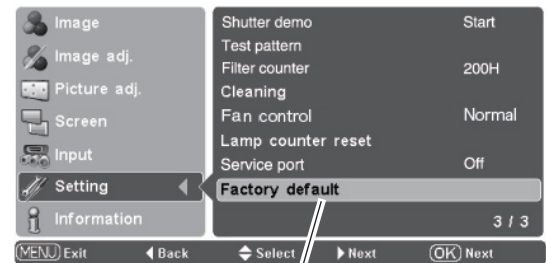

Select Factory default and press the Point ► or OK buttons. "Return to Factory default?" appears.

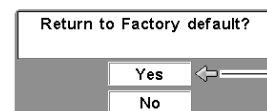

Select [Yes] and press the OK button, then another confirmation box appears.



Select [Yes] again to restore to the factory default settings.

# Information

## Input Source Information Display

The Information Menu is used for checking the status of the image signal being projected and the operation of the projector.

### Direct Operation

Press the INFO. button on the top control or on the remote control to display the Information Menu.

### Menu Operation

Press the Point ▲▼ buttons to select the Information Menu. The Information Menu is displayed.

See below for displayed information.

### Input

The selected input source is displayed.

### Signal

**Video or S-video** A color system of the connected video signal is displayed from among PAL, SECAM, NTSC, NTSC4.43, PAL-M, and PAL-N.

**Component** A system mode of the connected video signal is displayed from among 480i, 480p, 575i, 575p, 720p, 1080i and 1080p.

**HDMI** A system mode of the connected video signal is displayed from among D-VGA, D-WXGA, D-480i, D-480p, D-575i, D-575p, D-720p, D-1080i, and D-1080p.

**PC** A resolution of the connected computer signal is displayed.

**No signal** When there is no signal input, “-----” is displayed.

**Out of recognition** When the connected input source is out of recognition, “Unknown” is displayed.

### H-sync freq.

The horizontal frequency of the input signal is displayed in KHz, or “-----” when no signal.

### V-sync freq.

The vertical frequency of the input signal is displayed in Hz, or “-----” when no signal. Numbers of Hz doubles when during Interlace.

### Deep color

The deepness of the color in HDMI input signal is displayed, or “-----” when 8 bit signal.

### Image

The selected image mode is displayed.

### Screen

The selected screen size is displayed.

### Lamp status

The selected lamp mode is displayed.

### Lamp time

The cumulative lamp operating time is displayed.

### Filter time

The cumulative filter operating time is displayed.

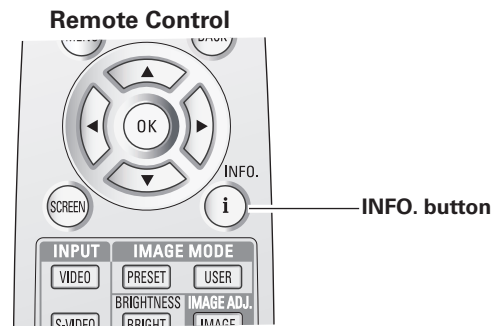
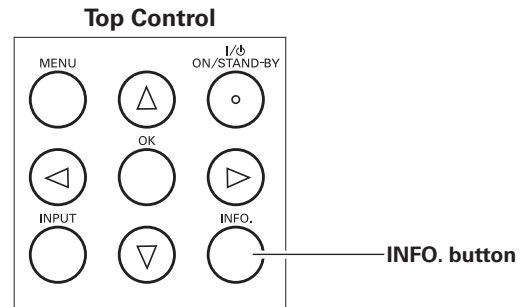

### Information Menu

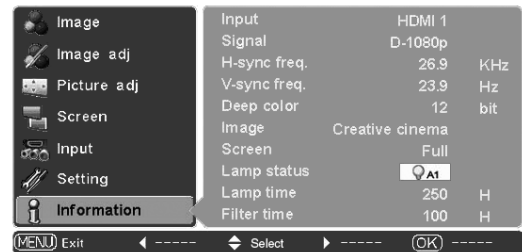

# Maintenance and Cleaning

## Warning Indicator

The WARNING indicator shows the state of the function that protects the projector. Check the state of the WARNING indicator and the POWER indicator to take proper maintenance.

### ***The projector is shut down and the WARNING indicator is blinking red.***

When the temperature inside the projector reaches a certain level, the projector is automatically shut down to protect its inside. The POWER indicator is blinking while the projector is being cooled down. When the projector has cooled down sufficiently (to its normal operating temperature), it can be turned on again by pressing the POWER ON/STAND-BY button.

#### ✓ **Note:**

- *The WARNING indicator continues to blink even after the temperature inside the projector returns to normal. When the projector is turned on again, the WARNING indicator stops blinking.*

#### **Then check the items below.**

- Did you provide appropriate space for the projector to be ventilated? Check the installing condition to see if ventilation slots are not blocked.
- Has the projector been installed near an Air-Conditioning/Heating Duct or Vent? Move the installation of the projector away from the duct or vent.
- Is the air filter clean? Clean the air filter periodically or replace it with a new one.

### ***The projector is shut down and the WARNING indicator lights red.***

When the projector detects an abnormal condition, it is automatically shut down to protect the inside of the projector and the WARNING indicator lights red. In this case, unplug the AC power cord and plug it, and then turn on the projector once again to verify operation. If the projector cannot be turned on and the WARNING indicator lights red, unplug the AC power cord and contact the service station.



#### **CAUTION**

DO NOT LEAVE PROJECTOR WITH AC POWER CORD CONNECTED UNDER AN ABNORMAL CONDITION. IT MAY RESULT IN FIRE OR ELECTRIC SHOCK.

#### **TOP CONTROL**

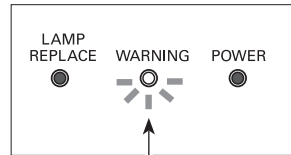

WARNING  
blinking red

#### **TOP CONTROL**

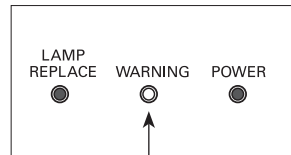

WARNING  
lights red.

## Cleaning the RGB panels

Blemishes such as dust and dirt on the internal optical components of the projector tend to degrade the brightness of the screen and are likely to appear as a shadow on the screen, which can lead to deterioration of image quality.

This projector has the RGB panel cleaning holes on the underside for cleaning of the internal parts (such as optical components) of the projector. When you use the projector for a lengthy period of time or a shadow of dust appears on the projected screen, clean the inside of the projector.

Using the supplied air blower and with the Cleaning function in the Setting Menu (p.42), you can remove the dusts from the projector.

✓ **Note:**

- Dust might not be removed completely with these steps. Then contact the dealer where you purchased the projector or service center.



CAUTION



PROHIBITED

### CAUTION IN USING THE AIR BLOWER AND THE NOZZLE

- Turn the projector over when using the blower.
- Use only the supplied air blower and nozzle to keep the projector from being out of order or damaged. We could not guarantee the malfunction or breakage caused by other tools.
- Never use a commercially available compressed air duster. It causes the interior of the projector to malfunction with release of cold liquid propellant.
- Put the projector on a soft cloth to prevent scratching the surface.
- Open the hole cover only when you clean the inside of the projector.
- Do not look into the holes. A strong light could damage your eyes. (Do not look into the Air intake vent and Exhaust vent, too.)
- Use the blower and nozzle only to clean the projector. Do not attempt to use them for other purposes. Do not use the blower and nozzle against persons (particularly to eyes, mouth, or ears). Be especially careful to ensure that children do not put the blower and nozzle into their mouth and swallow them.
- Do not attempt to pull the nozzle out of the blower. If the nozzle happened to be pulled out, put it back into the blower immediately.
- Do not use the blower supplied with this projector (model: Z4000) to clean the other models: Z3 and Z1X.

If something is wrong with the projector (such as smoke, a strange sound, or an abnormal odor) while you are cleaning, turn off and unplug the projector immediately, then call the dealer where you purchased the projector or service center.

### If the nozzle is pulled out ....

The nozzle has the stopper. Put the stopper-side of the nozzle into the blower. Put the nozzle firmly into the blower until the stopper becomes invisible.

When putting the nozzle into the blower, hold near the stopper so that it will not break.

Be sure not to try to pull the nozzle out of the blower.

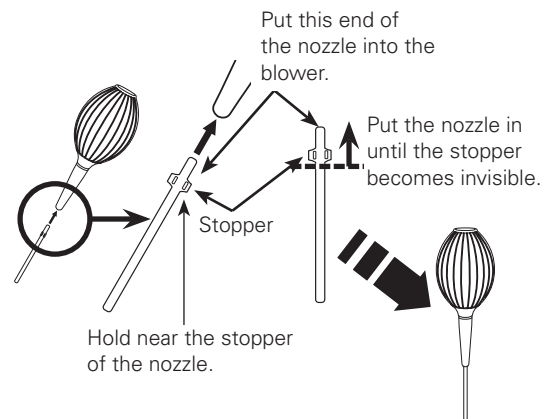

## Clean by using the Cleaning function in the Setting Menu

- 1** Turn the projector on and press the MENU button to display the On-Screen Menu. Select the Setting Menu with the Point ▲▼ buttons. Press the Point ► or OK buttons to access the submenu items.
- 2** Select Cleaning and then press the Point ► or OK buttons. The screen is blacked out temporarily.
- 3** Turn the projector over. Put your finger on the hole cover's tab and pull to open the hole cover.
- 4** Put the blower's nozzle into a hole.
- 5** Blow air into the projector with the blower watching the position of the dust from the screen.
- 6** When cleaning is done, pull the blower out of the hole and replace the hole cover.
- 7** Set the projector back into the right position, then press any button on the top control or on the remote control to quit the Cleaning function.

\* Do not open the hole cover except when you clean the inside of the projector to prevent foreign matters from getting into the projector. If it is open especially while operating the projector, the optical parts could damage.

### Which hole to put the nozzle in?

When you look at the screen:

- When red spots (dust) are particularly noticeable, put the nozzle into the R panel cleaning holes.
- When green spots (dust) are particularly noticeable, put the nozzle into the G panel cleaning holes.
- When blue spots (dust) are particularly noticeable, put the nozzle into the B panel cleaning holes.

### Cleaning

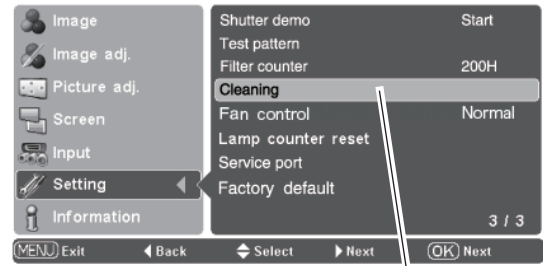

Select Cleaning in the Setting Menu.

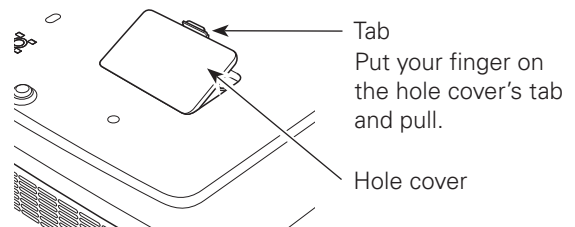

The nozzle will go no further than a certain point when it is put into the hole. Do not attempt to push the nozzle further in, or it could break and be stuck inside of the projector.

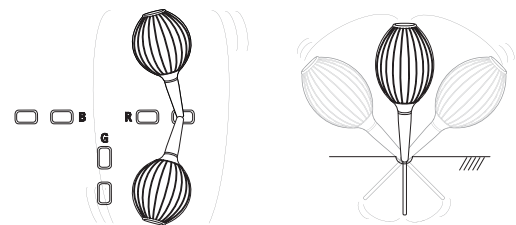
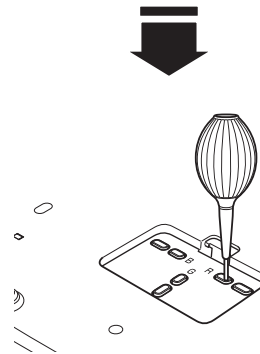

Wave the nozzle back and forth inside of the projector.

(Do not attempt to bend the nozzle.)



Use only the supplied blower and nozzle. Do not use a commercially available compressed air duster. It causes the interior of the projector to malfunction with release of cold liquid propellant. We could not guarantee the malfunction of breakage by using other tools.

## Cleaning the Air Filter

The air filter prevents dust from accumulating on the surface of the optical elements inside the projector. Should the air filter become clogged with dust particles, it will reduce cooling fan's effectiveness and may result in a buildup of internal heat and adversely affect the life of the projector. Clean the air filter by following the steps below.

- 1** Unplug the AC power cord before cleaning.
- 2** Press the latch and release it. Take off the filter cover.
- 3** Pull out the air filter.  
When taking out the air filter, put your fingers on the air filter's tabs and pull. Do not try to pull the delicate filter part.
- 4** Remove dust and dirt with a soft brush or a vacuum cleaner. Be careful not to damage the air filter and do not clean it with water.  
When the air filter gets dusty and dirty, replace it with a new one. For ordering the replacement filter, contact your sales dealer.
- 5** Put the air filter back into the position. Do not push the delicate filter part. Make sure that the air filter is properly and fully inserted.
- 6** Close the filter cover.
- 7** **Reset the filter counter** (p.48).

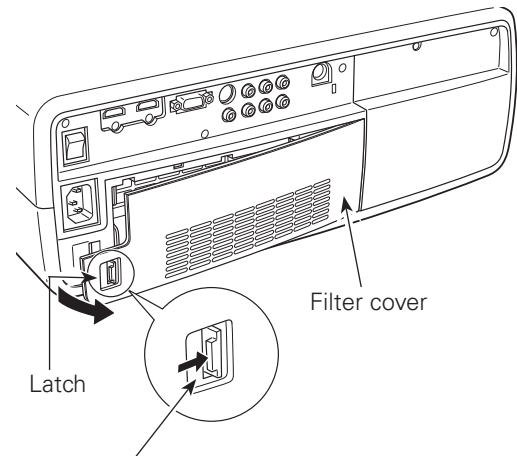

Press the latch and take off the filter covers.

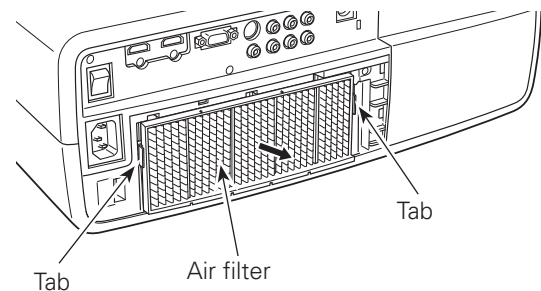

### RECOMMENDATION

**We recommend avoiding dusty/smoky environments when operating the projector. Usage in these environment may cause a poor image quality.**

When using the projector under dusty or smoky conditions, dust may accumulate on a lens, LCD panels, or optical elements inside the projector degrading the quality of a projected image.

When the symptoms above are noticed, contact your authorized dealer or service station for proper cleaning.



### CAUTION

Do not operate the projector with the air filters removed. Dust may accumulate on the optical elements degrading picture quality. Do not put anything into the air intake vents. Otherwise it may result in malfunction of the projector.

When putting back the air filter, make sure that the arrows on the filter are facing towards the projector.

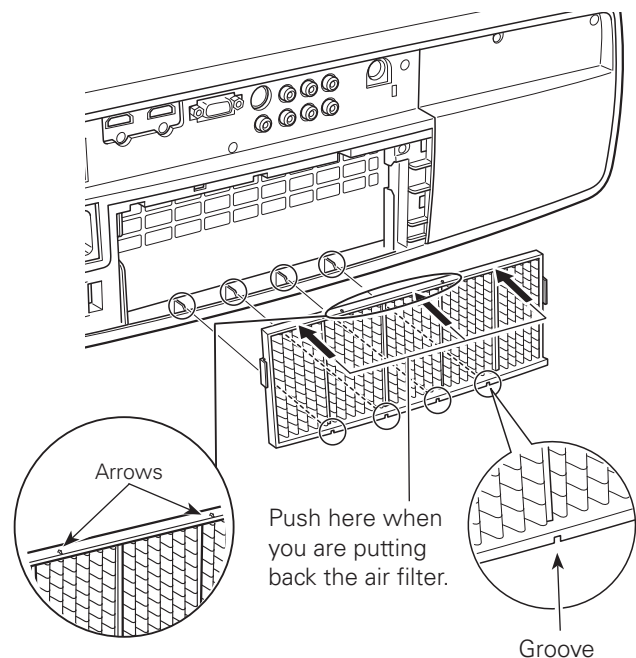

## Resetting the Filter Counter

Be sure to reset the Filter counter after cleaning or replacing the air filter.

- 1 Turn the projector on and press the MENU button to display the On-Screen Menu. Select the Setting Menu with the Point ▲▼ buttons. Press the Point ► or OK buttons to access the submenu items.
- 2 Select Filter counter and then use the Point ► button to select [Reset] and press the OK button. "Filter counter reset?" appears. Select [Yes] and then press the OK button.
- 3 Another confirmation dialog box appears, and select [Yes] to reset the Filter counter.

✓ **Note:**

- Do not reset the Filter counter without cleaning or replacing the air filter. Be sure to reset the Filter counter only after cleaning or replacing the air filter.

### Filter counter

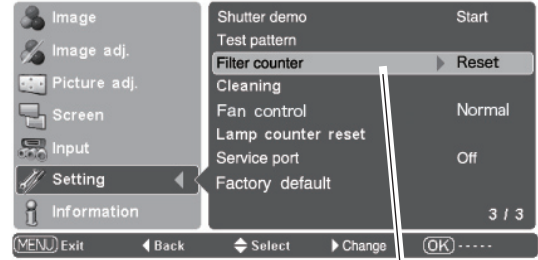

Select Filter counter and use the Point ► button to select [Reset] and press the OK button. "Filter counter reset?" appears.

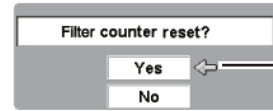

Select [Yes] and press the OK button, then another confirmation box appears.



Select [Yes] again to reset the lamp counter.

## Cleaning the Projection Lens

Unplug the AC power cord before cleaning.

Gently wipe the projection lens with a cleaning cloth that contains a small amount of non-abrasive camera lens cleaner, or use a lens cleaning paper or a commercially available air blower to clean the lens. Avoid using an excessive amount of cleaner. Abrasive cleaners, solvents, or other harsh chemicals might scratch the surface of the lens.

When the projector is not in use, make sure that the automatic slide shutter is closed.

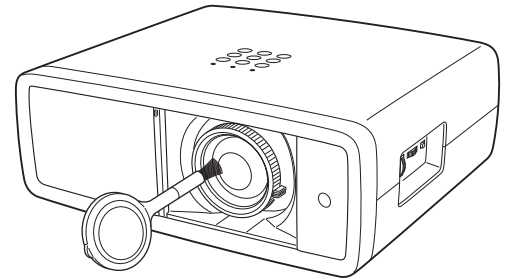

## Cleaning the Projector Cabinet

Unplug the AC power cord before cleaning.

Gently wipe the projector body with a dry soft cloth. When the cabinet is heavily soiled, apply a small amount of mild detergent and finish with a dry soft cloth. Avoid using an excessive amount of cleaner. Abrasive cleaners, solvents, or other harsh chemicals might scratch the surface of the cabinet.

When the projector is not in use, put it in an appropriate carrying case to protect it from dust and scratches.

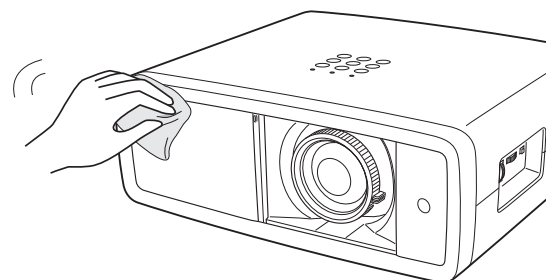



## Lamp Replacement

When the projection lamp of this projector reaches its end of life, the LAMP REPLACE indicator emits yellow light. If this indicator lights yellow, replace the lamp with a new one promptly. The time when the LAMP REPLACE indicator should light is depending on the lamp mode.

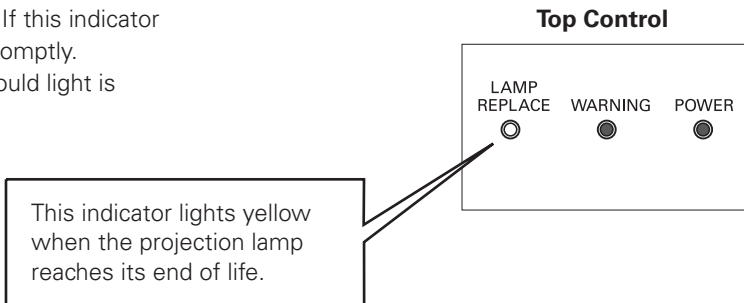

### CAUTION

Allow the projector to cool, for at least 45 minutes before you open the lamp cover. The inside of the projector can become very hot.



### CAUTION

For continued safety, replace the lamp with the same type lamp. Do not drop the lamp or touch the glass bulb! The glass can shatter and may cause injury.

Follow these steps to replace the lamp.

- 1** Turn off the projector and unplug the AC power cord. Let the projector cool for at least 45 minutes.
- 2** Loosen the screw that secures the lamp cover, and then open the lamp cover.
- 3** Loosen the two (2) screws that secure the lamp. Pull out the lamp by using the built in handle.
- 4** Replace the lamp with a new one and secure it with the two (2) screws. Make sure that the lamp is set properly. Put the lamp cover back and secure it with the screw.
- 5** Connect the AC power cord to the projector and turn on the projector.
- 6** **Reset the Lamp replacement counter** (p.50).

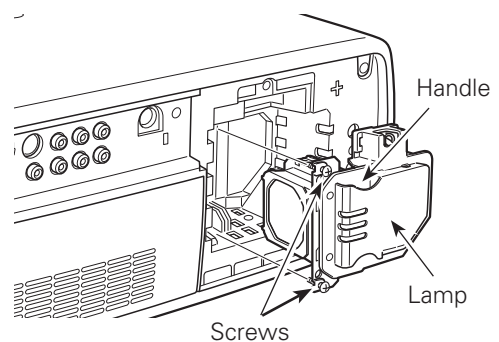
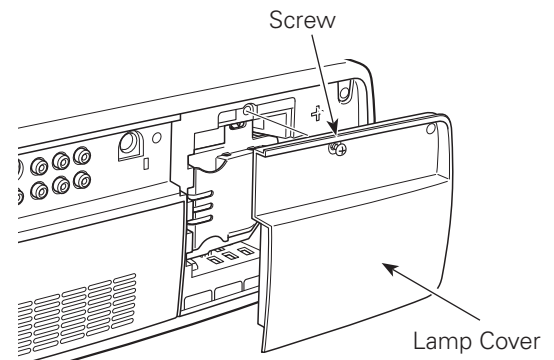

### ORDER REPLACEMENT LAMP

Replacement lamp can be ordered through your dealer. When ordering a projection lamp, give the following information to the dealer.

- **Model No. of your projector:**
- **Replacement Lamp Type No.:**

**PLV-Z4000**

**POA-LMP135**

(Service Parts No. 610 344 5120)

## Resetting the Lamp Replacement Counter

Be sure to reset the lamp replacement counter after the lamp is replaced. When the lamp replacement counter is reset, the LAMP REPLACE indicator stops lighting.

- 1 Turn the projector on and press the MENU button to display the On-Screen Menu. Select the Setting Menu with the Point ▲▼ buttons. Press the Point ► or OK buttons to access the submenu items.
- 2 Select Lamp counter reset and then press the Point ► or OK buttons. "Lamp replacement counter reset?" appears. Select [Yes] and then press the OK button.
- 3 Another confirmation dialog box appears, and select [Yes] to reset the Lamp replacement counter.

✓ **Note:**

- Do not reset the Lamp replacement counter without implementing lamp replacement. Be sure to reset the Lamp replacement counter only after replacing the lamp.

### Lamp counter reset

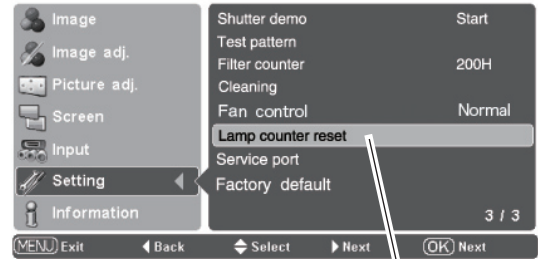

Select Lamp counter reset and press the Point ► or OK buttons. "Lamp replacement counter reset?" appears.

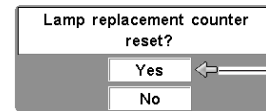

Select [Yes] and press the OK button, then another confirmation box appears.



Select [Yes] again to reset the lamp counter.



## LAMP HANDLING PRECAUTIONS

This projector uses a high-pressure lamp which must be handled carefully and properly. Improper handling may result in accidents, injury, or create a fire hazard.

- Lamp lifetime may differ from lamp to lamp and according to the environment of use. There is no guarantee of the same lifetime for each lamp. Some lamps may fail or terminate their lifetime in a shorter period of time than other similar lamps.
- If the projector indicates that the lamp should be replaced, i.e., if the LAMP REPLACE indicator lights up, replace the lamp with a new one IMMEDIATELY after the projector has cooled down. (Follow carefully the instructions in the Lamp Replacement section of this manual.) Continuous use of the lamp with the LAMP REPLACE indicator lighted may increase the risk of lamp explosion.
- A Lamp may explode as a result of vibration, shock or degradation as a result of hours of use as its lifetime draws to an end. Risk of explosion may differ according to the environment or conditions in which the projector and lamp are being used.

### IF A LAMP EXPLODES, THE FOLLOWING SAFETY PRECAUTIONS SHOULD BE TAKEN.

If a lamp explodes, disconnect the projector's AC plug from the AC outlet immediately. Contact an authorized service station for a checkup of the unit and replacement of the lamp. Additionally, check carefully to ensure that there are no broken shards or pieces of glass around the projector or coming out from the cooling air circulation holes. Any broken shards found should be cleaned up carefully. No one should check the inside of the projector except those who are authorized trained technicians and who are familiar with projector service. Inappropriate attempts to service the unit by anyone, especially those who are not appropriately trained to do so, may result in an accident or injury caused by pieces of broken glass.

## Troubleshooting

---

Before calling your dealer or service center for assistance, check the items below once again.

- Make sure you have properly connected the projector to peripheral equipment as described in “Connecting to Video Equipment” and “Connecting to a Computer” on pages 15 – 16.
- Make sure all equipment is connected to an AC outlet and the power is turned on.
- When you operate the projector with a computer and it does not project an image, restart the computer.

<b>Problem:</b>	<b>–Solutions</b>
<b>No power.</b>	<ul style="list-style-type: none"><li>– Plug the power cord of the projector into an AC outlet.</li><li>– See if the automatic slide shutter is only half-open. When it is half-open, the POWER indicator blinks orange and the projector cannot be turned on (see page 18).</li><li>– See if the Main On/Off switch is on.</li><li>– Wait 90 seconds after the projector is turned off to restart the projector. The projector can be turned on after the POWER indicator turns red (see page 19).</li><li>– Check the WARNING indicator. If the WARNING indicator lights red, the projector cannot be turned on (see page 44).</li><li>– Check the projection lamp (see page 49).</li><li>– Check if the projector is installed on a flat surface.</li></ul>
<b>Lens Shift does not work.</b>	<ul style="list-style-type: none"><li>– Release the Lens Shift Lock (see page 14).</li></ul>
<b>The initial display is not shown.</b>	<ul style="list-style-type: none"><li>– Make sure “Off” or “Countdown Off” are not chosen at Display function (see page 40).</li></ul>
<b>The initial display is not same with the default one.</b>	<ul style="list-style-type: none"><li>– Make sure “User” or “Off” are not chosen at Logo function (see page 40).</li></ul>
<b>Filter warning icon appears during turning on the projector or switching the input source.</b>	<ul style="list-style-type: none"><li>– Check the air filter (see pages 42, 47).</li></ul>
<b>Image is out of focus.</b>	<ul style="list-style-type: none"><li>– Adjust the focus of the projector (see page 22).</li><li>– Provide proper distance between the projector and the projection screen (see page 13).</li><li>– Check the projection lens to see if it needs cleaning (see page 48).</li><li>– Moving the projector from a cool to warm place may result in moisture condensation on the projection lens. If this occurs, leave the projector off and wait until condensation evaporates.</li><li>– Projecting from the excessive slant angle to the screen may cause keystone distortion and partial imperfect focus (see page 14).</li></ul>
<b>No image.</b>	<ul style="list-style-type: none"><li>– Check the connection between your computer or video equipment and the projector (see pages 15 – 16).</li><li>– See if the input signal is correctly output from your computer. For some laptop computers, the setting for the monitor output needs to be changed when connecting to a projector. See your computer’s instruction manual for the setting.</li><li>– It takes about 20 seconds to display an image after turning on the projector.</li><li>– See if the selected system is corresponding to your computer or video equipment (see pages 24 – 26).</li><li>– Select a correct input source once again through Menu operation (see pages 25 – 26).</li><li>– Make sure the temperature is not out of the specified operating temperature (41°F – 95°F [5°C – 35°C]).</li><li>– When “No show” is operating, the image cannot be displayed. Press the NO SHOW button or any other button on the remote control (see page 23).</li><li>– When “Cleaning” is operating, the image cannot be displayed. Press any button on the top control or on the remote control (see page 42).</li></ul>
<b>Picture is not bright enough.</b>	<ul style="list-style-type: none"><li>– Check if “Contrast” or “Brightness” are adjusted properly (see page 28).</li><li>– Check if “Image mode” is selected properly (see page 27).</li><li>– Check the LAMP REPLACE indicator. If it lights, the end of lamp life is approaching. Replace the lamp with a new one promptly. (see pages 49-50, 53).</li><li>– Check the Lamp control function (see pages 23, 29).</li></ul>

<b>Problem:</b>	<b>–Solutions</b>
<b>Horizontal line noise occurs.</b>	–When connecting HDTV equipment to the projector’s COMPONENT 1/2 terminals, horizontal line noise may be noted only occasionally. Then adjust the value of <i>Fine sync</i> . (see page 34).
<b>Image is Left/Right reversed. Image is Top/Bottom reversed.</b>	–Check the Ceiling/Rear item (see page 37). –Check the Ceiling item (see page 37).
<b>The edge of the image is distorted.</b>	–With maximum lens shift, image distortion may be observed (see page 14).
<b>Auto adj. does not work.</b>	–The Auto adj. function cannot be operated with the video input, some incompatible computer input and digital signals (see page 34).
<b>Image is distorted or runs off.</b>	–Check “Picture adj.” menu or “Screen” menu and adjust them.
<b>Some displays are not seen during operations.</b>	–Check the Display item (see page 40).
<b>The setting does not remain after turning off power.</b>	–Make sure you selected “Store” after adjusting settings. Some settings cannot be stored if not registered with “Store.”
<b>Power management does not work.</b>	–When “Freeze (p. 23),” “No show (p.23),” “Cleaning (p.42),” or “Test pattern (p.42)” are operating or Logo is displayed, the power management function cannot be operated (see page 41).
<b>Image disappears automatically.</b>	–Check the power management function in the Setting. The power management is set to “On” at the factory (see page 41).
<b>Capture function does not work.</b>	–Check the connection to see if there is signal.
<b>Some menus cannot be selected.</b>	–Check the connection to see if there is signal. “Image,” “Image adj.,” “Picture adj.,” and “Screen” cannot be selected without an input signal.
<b>Switching between HDMI 1 and HDMI 2 takes time.</b>	–When switching from HDMI 1 to HDMI 2 or vice versa, the signal may be interrupted for a moment depending on the equipment (see page 26).
<b>Image does not appear with HDMI 1 or HDMI 2.</b>	–Turn on the Video equipment again. –Check the connection of cables.
<b>The Remote Control does not work.</b>	–Check the batteries. –Make sure there is no obstruction between the projector and remote control. –Make sure you are not too far from the projector when using the remote control. Maximum operating range is 16.4’ (5 m). –Make sure the code of the remote control is conformed to that of the projector (see page 41).
<b>RESET button does not work.</b>	–This function is limited to when selecting the Image Adjustment Menu and Picture Adjustment Menu (see page 22).
<b>LOGO button does not work.</b>	–Check the Logo setting. Make sure Logo is not set to off. (see page 40).
<b>Indicators blinks or lights.</b>	–Check the status of the projector with referring to “Indicators and Projector Condition” (see page 53).
<b>Abnormal noise is detected during projection.</b>	–Motor noise or shutter noise can be heard when selecting or switching “Image,” or projecting an image with the large brightness fluctuation.
<b>The exclamation mark appears on the screen.</b>	–Your operation is invalid. Operate correctly.































## WARNING:

**High voltages are used to operate this projector. Do not attempt to open the cabinet.**

If problems still persist after following all operating instructions, contact the dealer where you purchased the projector or service center. Give the model number and explain about the problem. We will advise you how to obtain service.

## Indicators and Projector Condition

Check the indicators for projector's condition.

Indicators			Projector Condition
POWER red/green/ orange	WARNING red	LAMP REPLACE yellow	
			The Main On/Off switch is off or the AC power cord is unplugged.
			The projection lamp is being cooled down. The projector cannot be turned on until cooling is completed.
			The projector is ready to be turned on with the POWER ON/STAND-BY button.
			The projector is operating normally.
			The projector is in the Power management mode.
			The temperature inside the projector is abnormally high. The projector cannot be turned on. When the projector is cooled down enough and the temperature returns to normal, the POWER indicator emits red light and the projector can be turned on. (The WARNING indicator keeps blinking.) Check and clean the air filter.
			The projector has been cooled down enough and the inside temperature returns to normal. When turning on the projector, the WARNING indicator stops blinking. Check and clean the air filter.
			The projector detects an abnormal condition and cannot be turned on. Unplug the AC power cord and plug it again to turn on the projector. If the projector is turned off again, unplug the AC power cord and contact the dealer or service center for servicing and checkup. Do not leave the projector on. It may cause an electric shock or a fire hazard.
			The lamp does not turn on because malfunction occurs or the lamp reaches its end of life.
			The automatic slide shutter is not working properly.

 ●●● green

 ●●● blinking green

 ●●● blinking orange

 ●●● off

 ●●● red

 ●●● blinking red

 ●●● blinking yellow

\* When the projection lamp reaches its end of life, the LAMP REPLACE indicator lights yellow. When this indicator becomes yellow, replace the projection lamp with a new one promptly. Reset the Lamp replacement counter after replacing the lamp. The time when the LAMP REPLACE indicator should light is depending on the lamp mode. See pages 49 – 50.

## Menu Tree

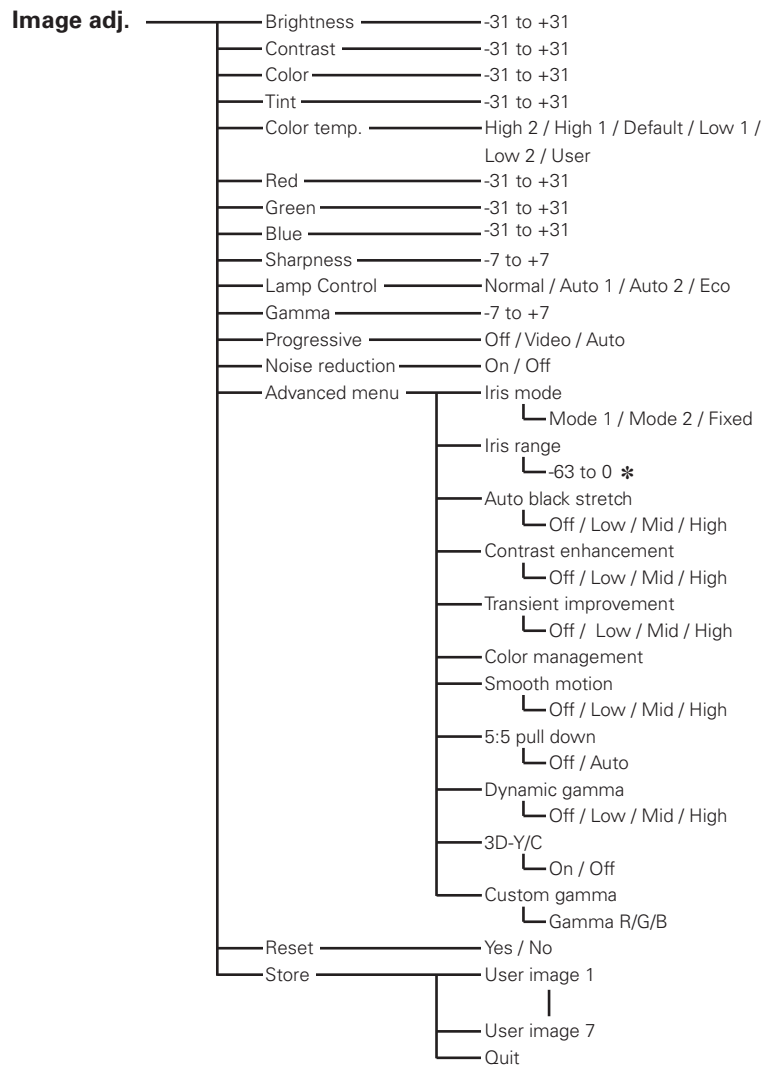
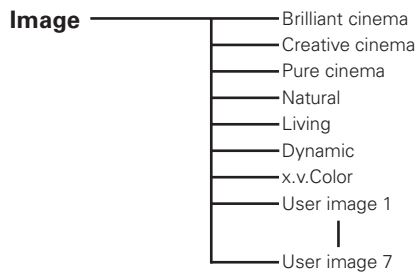
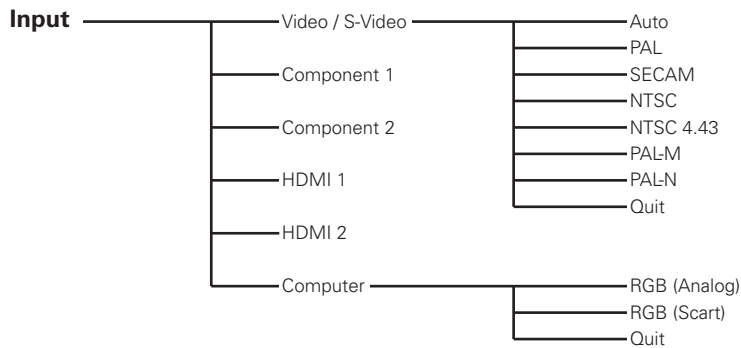

\* Value changes depending on the selected image mode.

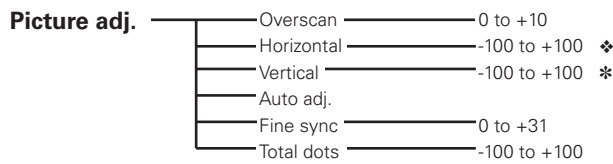

❖ --- When 480i/575i input, -8 to +8.  
 \* --- When 480i/575i input, -15 to +15.

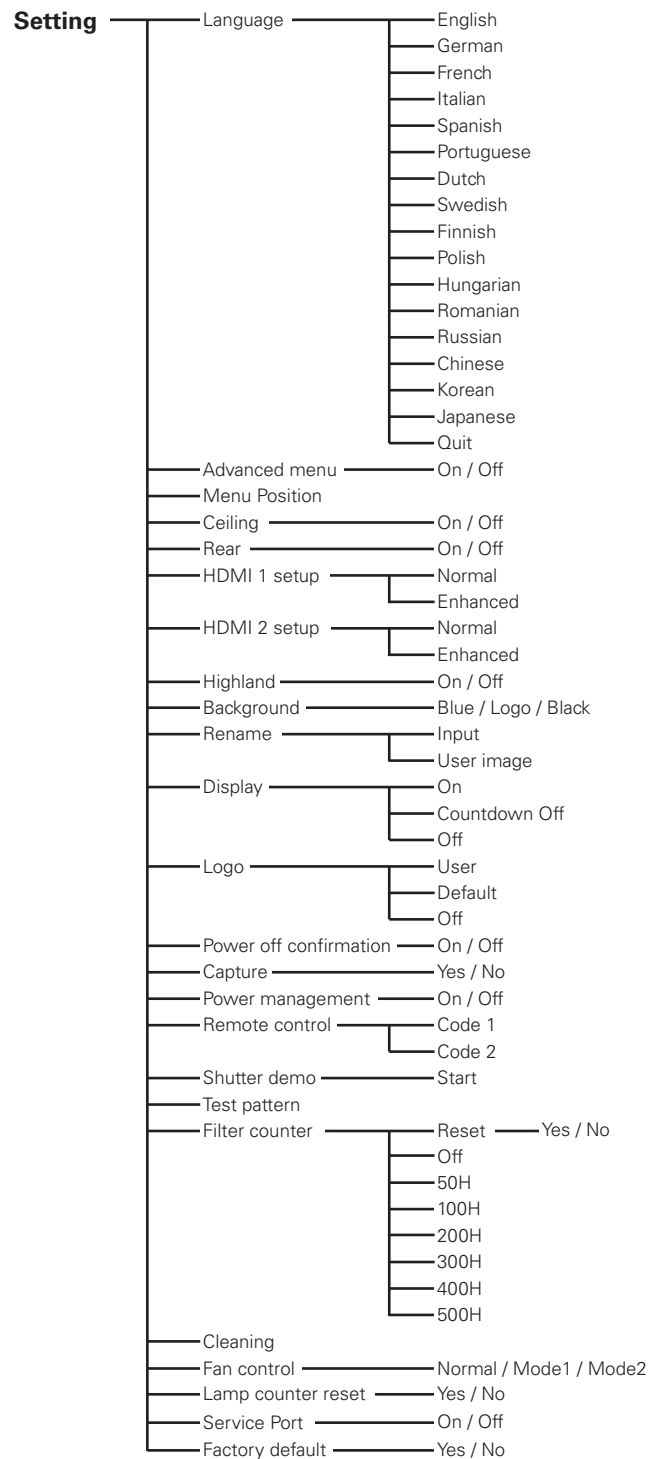
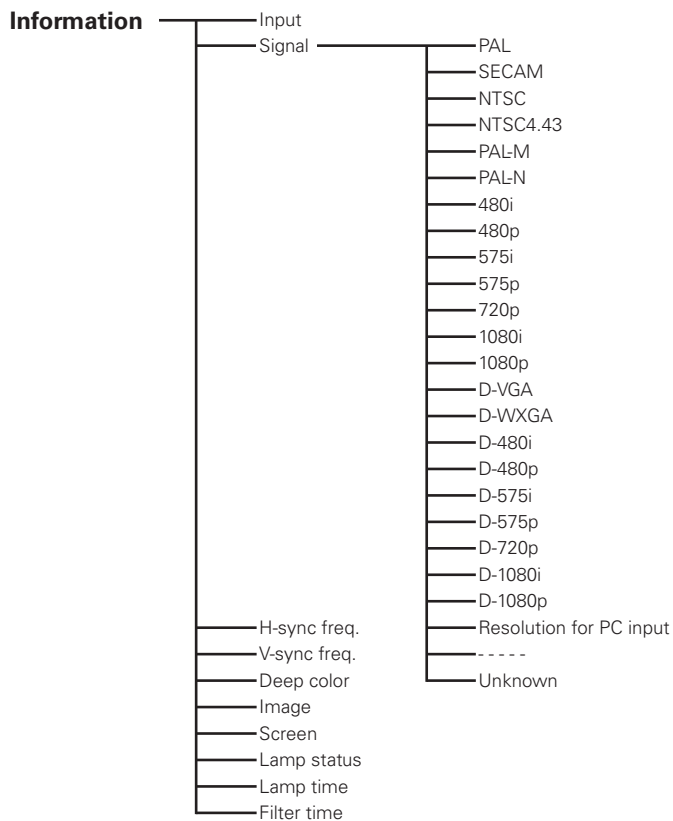
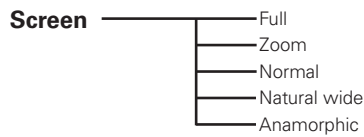

## System Mode Chart

PLV-Z4000 can basically accept the signal from all computers and some video equipment with V- and H-Frequency mentioned below and less than 100 MHz of Dot Clock.

System mode	H-Freq. (kHz)	V-Freq. (Hz)
640x480	31.47	59.88
640x480	37.86	74.38
640x480	37.85	72.81
640x480	37.50	75.00
640x480	43.269	85.00
720x400	37.927	85.039
640x480	35.00	66.67
832x624	49.72	74.55
1152x870	68.68	75.06
800x600	35.156	56.25
800x600	37.88	60.32
800x600	46.875	75.00
800x600	53.674	85.06
800x600	48.08	72.19
800x600	37.90	61.03
800x600	34.50	55.38
800x600	38.60	60.31
800x600	32.70	51.09
848x480	31.02	60.00

System mode	H-Freq. (kHz)	V-Freq. (Hz)
1024x768	56.47	70.07
1024x768	44.00	54.58
1024x768	63.48	79.35
1024x768	62.04	77.07
1024x768	61.00	75.70
1024x768	46.90	58.20
1024x768	58.03	72.00
1152x864	64.20	70.40
1152x900	61.20	65.20
1152x900	61.85	66.00
1280x768	47.776	59.87
1280x768	60.289	74.893
720x480	15.73	59.94/60
720x575	15.63	50.00
1280x720	37.50	50.00
720p	45.00	60.00
1080i	33.75	30.00 (Interlace)
1080i	28.12	25.00 (Interlace)
1080p	56.25	50.00
1080p	67.50	60.00

When the input signal is digital from the HDMI terminal, refer to the chart below.

System mode	RESOLUTION	H-Freq. (kHz)	V-Freq. (Hz)
D-VGA	640x480	–	59.94/60
D-WXGA	1280x768	47.776	59.870
D-WXGA	1280x768	60.289	74.893
D-WXGA	1280x768	68.633	84.837
D-480i	720x480	–	59.94/60
D-575i	720x575	–	50.00
D-480p	720x480	–	59.94/60
D-575p	720x575	–	50.00

System mode	RESOLUTION	H-Freq. (kHz)	V-Freq. (Hz)
D-720p	1280x720	–	59.94/60
D-720p	1280x720	–	50.00
D-1080i	1920x1080	–	59.94/60
D-1080i	1920x1080	–	50.00
D-1080p	1920x1080	–	59.94/60
D-1080p	1920x1080	–	50.00
D-1080p	1920x1080	–	24.00

✓ **Note:**

- You might be able to project images even when signals other than above are inputted, however the functions of the projector could be limited.



## Technical Specifications

<b>Projector Type</b>	Multimedia Projector
<b>Dimensions (W x H x D)</b>	15.75" x 5.75" x 13.62" (400 mm x 146 mm x 346 mm) (not including raised portions)
<b>Net Weight</b>	16.5 lbs (7.5 kg)
<b>LCD Panel System</b>	0.74" wide TFT Active Matrix type, 3 panels
<b>Panel Resolution</b>	1920 x 1080 dots
<b>Number of Pixels</b>	6,220,800 (1920 x 1080 x 3 panels)
<b>Color System</b>	PAL, SECAM, NTSC, NTSC4.43, PAL-M, and PAL-N
<b>High Definition TV Signal</b>	480i, 480p, 575i, 575p, 720p, 1080i, and 1080p
<b>Scanning Frequency</b>	H-sync. 15 kHz – 80 kHz, V-sync. 50 Hz – 100 Hz
<b>Projection Image size (Diagonal)</b>	Adjustable from 40" to 300"
<b>Projection Lens</b>	F 2.0 – 3.05 lens with f 22.6 – 45.3 mm with manual zoom and focus
<b>Throw Distance</b>	3.9' – 60.4' (1.2 m – 18.4 m)
<b>Projection Lamp</b>	165 W
<b>Video Input Jacks</b>	RCA Type x 1 (Video), RCA Type x 3 (Y, Pb/Cb, Pr/Cr) x 2 and Mini DIN 4 pin x 1 (S-video)
<b>Computer Input Terminal</b>	mini D-sub 15 pin x 1
<b>HDMI Input Terminals</b>	HDMI terminal 19 pin x 2
<b>Service Port Connector</b>	Mini DIN 8 pin x 1
<b>Feet Adjustment</b>	0° to 6.5°
<b>Voltage and Power Consumption</b>	AC 100 – 120 V (2.9 A Max. Ampere), 50/60 Hz (The U.S.A. and Canada) AC 200 – 240 V (1.6 A Max. Ampere), 50/60 Hz (Continental Europe and The U.K.)
<b>Operating Temperature</b>	41°F – 95°F (5°C – 35°C)
<b>Storage Temperature</b>	14°F – 140°F (-10°C – 60°C)
<b>Remote Control</b>	Power Source : AA or LR6 1.5 V ALKALINE Type x 2 Operating Range : 16.4' (5 m)/±30° Dimensions : 2.13" x 1.04" x 6.81" (54 mm x 26.3 mm x 173mm) Net Weight : 3.4 oz (95.5 g) (not including batteries)
<b>Accessories</b>	Owner's Manual (CD-ROM) Quick Reference Guide AC Power Cord Remote Control and Batteries Air Blower

- The specifications are subject to change without notice.
- LCD panels are manufactured to the highest possible standards. Even though 99.99% of the pixels are effective, a tiny fraction of the pixels (0.01% or less) may be ineffective by the characteristics of the LCD panels.



This symbol on the nameplate means the product is Listed by Underwriters Laboratories Inc. It is designed and manufactured to meet rigid U.L. safety standards against risk of fire, casualty and electrical hazards.



The CE Mark is a Directive conformity mark of the European Community (EC).



Pixelworks ICs used.

## Configurations of Terminals

### Video terminal

Terminal: HDMI

#### Pin Configuration

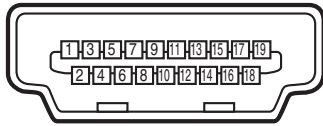

19 Pin Type A

1	TMDS Data 2+ Input	11	Ground (TMDS Clock)
2	Ground (TMDS Data 2)	12	TMDS Clock- Input
3	TMDS Data 2- Input	13	----
4	TMDS Data 1+ Input	14	----
5	Ground (TMDS Data 1)	15	SCL
6	TMDS Data 1- Input	16	SDA
7	TMDS Data 0+ Input	17	Ground (DDC/CEC)
8	Ground (TMDS Data 0)	18	+5V Power
9	TMDS Data 0- Input	19	Plug insert detection
10	TMDS Clock+ Input		

### Computer terminal

Terminal: VGA

#### Pin Configuration

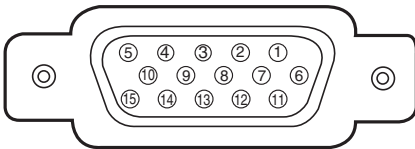

1	Red Input	9	----
2	Green Input	10	Ground (Vert.sync.)
3	Blue Input	11	Ground
4	----	12	----
5	Ground (Horiz.sync.)	13	Horiz.sync. Input (Composite H/V sync.)
6	Ground (Red)	14	Vert.sync.
7	Ground (Green)	15	----
8	Ground (Blue)		

## Optional Parts

The parts listed below are optional. When ordering these parts, specify item name and Type No. to the sales dealer.

- **HDMI Cable** **Type No.:** **POA-CA-HDMI**  
(Category 1: This cable is compatible with HDMI 1.0 to 1.2a. When connecting to reproduction equipment compatible with HDMI 1.3 (or next version), please use a HDMI Category 2 cable commercially available.)
- **Component Cable (32.8'/10m)** **Type No.:** **POA-CA-COMP10**
- **Scart-VGA Cable** **Type No.:** **POA-CA-SCART**  
(This cable is used for RGB Scart 21-Pin Video output of video equipment.)

### Dimensions

Unit: inch (mm)

