

USER MANUAL

020-000772-02

H Series

D12HD-H/D12WU-H



CHRISTIE®

The CD included with this printed manual contains an electronic copy in English. Please read all instructions before using or servicing this product.

手册中包含的光盘，带有着中文的电子副本，使用或维修本产品前，请仔细阅读所有的指示。

Le DC fourni avec ce manuel imprimé contient une copie électronique en français. S'il vous plaît lire toutes les instructions avant d'utiliser ou de réparer ce produit.

Die mit dieser gedruckten Anleitung gelieferte CD enthält eine elektronische Kopie in Deutsch. Bitte lesen Sie alle Anweisungen, bevor Sie dieses Produkt verwenden oder warten.

Il CD fornito con il manuale stampato contiene una copia elettronica in lingua italiano. Si prega di leggere tutte le istruzioni prima di utilizzare o riparare questo prodotto.

この印刷されたマニュアルに同梱されております CD には、日本語での説明書が入っております。この製品を使用あるいは修理点検される際に、ご参照下さい。

매뉴얼과 함께 포함되어 있는 CD 에는 한글로 된 전자사본을 포함하고 있습니다 . 본 제품을 사용 혹은 서비스하기 전에 모든 지침 사항들을 읽어 보시기 바랍니다 .

Поставляемый в комплекте с документацией компакт-диск (CD) содержит электронную копию руководства пользователя на русском языке. Перед началом использования изделия или проведения сервиса пожалуйста прочтите все инструкции изложенные в руководстве.

El DC incluido con este manual impreso contiene una copia electrónica en español. Por favor, lea todas las instrucciones antes de usar o dar servicio a este producto.

NOTICES

COPYRIGHT AND TRADEMARKS

Copyright ©2015 Christie Digital Systems USA, Inc. All rights reserved.

All brand names and product names are trademarks, registered trademarks or trade names of their respective holders.

REGULATORY

The product has been tested and found to comply with the limits for a Class A digital device, pursuant to Part 15 of the FCC Rules. These limits are designed to provide reasonable protection against harmful interference when the product is operated in a commercial environment. The product generates, uses, and can radiate radio frequency energy and, if not installed and used in accordance with the instruction manual, may cause harmful interference to radio communications. Operation of the product in a residential area is likely to cause harmful interference in which case the user will be required to correct the interference at the user's own expense.

WARNING! Changes or modifications not expressly approved by Christie could void the user's authority to operate the product.

FOR COMMERCIAL USE ONLY - POUR USAGE COMMERCIAL UNIQUEMENT

THIS DEVICE COMPLIES WITH PART 15 OF THE FCC RULES. OPERATION IS SUBJECT TO THE FOLLOWING 2 CONDITIONS: (1) THIS DEVICE MAY NOT CAUSE HARMFUL INTERFERENCE (2) THIS DEVICE MUST ACCEPT ANY INTERFERENCE RECEIVED, INCLUDING ANY INTERFERENCE THAT MAY CAUSE UNDESIRE OPERATION.

THIS CLASS A DIGITAL APPARATUS MEETS ALL REQUIREMENTS OF THE CANADIAN INTERFERENCE-CAUSING EQUIPMENT REGULATIONS.

CET APPAREIL NUMÉRIQUE DE CLASSE A EST CONFORME AUX NORMES DÉFINIES DANS LES RÉGLEMENTATIONS CANADIENNES SUR LES APPAREILS CAUSANT DES INTERFÉRENCES RADIO (CANADIAN INTERFERENCE-CAUSING EQUIPMENT REGULATIONS, ICES-003, CLASS A).

声明 此为 A 级产品，在生活环境中，该产品可能会造成无线干扰。在这种情况下，可能需要用户对其干扰采取切实可行的措施。

이 기기는 업무용 (A 급) 으로 전자파적합등록을 한 기기이오니 판매자 또는 사용자는 이점을 주의하시기 바라며, 가정 외의 지역에서 사용하는 것을 목적으로 합니다.

GENERAL

Every effort has been made to ensure accuracy, however in some cases changes in the products or availability could occur which may not be reflected in this document. Christie reserves the right to make changes to specifications at any time without notice. Performance specifications are typical, but may vary depending on conditions beyond Christie's control such as maintenance of the product in proper working conditions. Performance specifications are based on information available at the time of printing. Christie makes no warranty of any kind with regard to this material, including, but not limited to, implied warranties of fitness for a particular purpose. Christie will not be liable for errors contained herein or for incidental or consequential damages in connection with the performance or use of this material.

The product is designed and manufactured with high-quality materials and components that can be recycled and reused. This symbol  means that electrical and electronic equipment, at their end-of-life, should be disposed of separately from regular waste. Please dispose of the product appropriately and according to local regulations. In the European Union, there are separate collection systems for used electrical and electronic products. Please help us to conserve the environment we live in!

Canadian manufacturing facility is ISO 9001 and 14001 certified.

GENERAL WARRANTY STATEMENTS

For complete information about Christie's limited warranty, please contact your Christie dealer. In addition to the other limitations that may be specified in Christie's limited warranty, the warranty does not cover:

- a. Damage occurring during shipment, in either direction.
 - b. Problems caused by combination of the product with non-Christie equipment, such as distribution systems, cameras, video tape recorders, etc., or use of the product with any non-Christie interface device.
 - c. Damage caused by misuse, improper power source, accident, fire, flood, lightening, earthquake or other natural disaster.
 - d. Damage caused by improper installation/alignment, or by product modification, if by other than a Christie authorized repair service provider.
 - e. For LCD projectors, the warranty period specified applies only where the LCD projector is in "normal use". "Normal use" means the LCD projector is not used more than 8 hours a day, 5 days a week. For any LCD projector where "normal use" is exceeded, warranty coverage under this warranty terminates after 6000 hours of operation.
 - f. Failure due to normal wear and tear.
 - g. Projector lamps (See Christie's separate lamp program policy).
 - h. Damage caused by use of a projector lamp beyond the recommended lamp life, or use of a lamp supplied by a supplier other than Christie.
-

PREVENTATIVE MAINTENANCE

Preventative maintenance is an important part of the continued and proper operation of your product. Please see the Maintenance section for specific maintenance items as they relate to your product. Failure to perform maintenance as required, and in accordance with the maintenance schedule specified by Christie, will void the warranty.

- 1. SAFETY
- 2. INTRODUCTION
 - 2.1 Projector Components 2-1
 - 2.2 Built-in Keypad 2-4
 - 2.3 Input/Output (I/O) Panel 2-5
 - 2.4 Remote Control 2-6
 - 2.5 LED Status Indicators 2-8
- 3. INSTALLATION
 - 3.1 Connect to Computer 3-1
 - 3.2 Connect to Video Equipment 3-2
 - 3.3 Turn the Projector On 3-3
 - 3.4 Turn the Projector Off 3-3
 - 3.5 Adjust the Projector Position 3-4
 - 3.6 Calculate Lens Offset 3-6
 - 3.7 Removing and Installing the Lens 3-10
 - 3.8 Fuse Installation 3-11
 - 3.9 Filter Replacement 3-12
 - 3.10 Ceiling Mount Installation 3-12
- 4. OPERATION
 - 4.1 Size and Position Menu 4-2
 - 4.2 Image Settings Menu 4-6
 - 4.3 Configuration Menu 4-9
 - 4.4 Lamp 4-14
 - 4.5 Status Menu 4-16
 - 4.6 Input Switching & PIP Menu 4-18
 - 4.7 Language Menu 4-20
 - 4.8 Test Pattern Menu 4-20
 - 4.9 Web User Interface 4-21
 - 4.9.1 Logging On 4-21
 - 4.9.2 Main Tabbed Page - General 4-21
 - 4.9.3 Main Tabbed Page - Status 4-22
 - 4.9.4 Main Tabbed Page - Lens 4-22
 - 4.9.5 Network 4-23
 - 4.9.6 Tools 4-26
 - 4.9.7 Administrator Page 4-26
 - 4.9.8 About Page 4-27
 - 4.10 Christie Presenter 4-28
 - 4.10.1 Connect to the Projector 4-28
 - 4.10.2 Install Christie Presenter software 4-29
 - 4.10.3 Use Christie Presenter 4-30
 - 4.11 Card Reader Operation 4-36
- 5. TROUBLESHOOTING
- 6. SPECIFICATIONS
 - 6.1 Inputs 6-1
 - 6.2 PIP/POP Compatibility 6-7

6.3	Key Features	6-8
6.4	List of Components	6-8
6.5	Optional Accessories	6-9
6.6	REGULATORY	6-9
6.7	Federal Communications Commission (FCC) Warning	6-10
6.8	OSD Tree.....	6-11

1. SAFETY

Read through this document in its entirety and understand all warnings and precautions before attempting to operate the projector.

⚠ WARNING

- Do not look into the projector lens when the lamp is on. The bright light may result in permanent eye damage.
- To reduce the risk of fire or electric shock, do not expose this projector to rain or moisture.
- Do not open or disassemble the projector as this may cause electric shock.
- All installation and maintenance procedures must be performed by a Christie accredited service technician.
- Keep all combustible material away from the concentrated light beam of the projector.
- Position all cables where they cannot contact hot surfaces or be pulled or tripped over.
- Always power down the projector and disconnect all power sources before servicing or cleaning.
- Use a soft cloth moistened with a mild detergent to clean the display housing.
- Disconnect the power plug from the AC outlet if the product is not being used for an extended period of time.
- Operate the projector under the following conditions:
 - Operating temperature range: 0°C to 40°C
 - Storage temperature range: -10°C to 60°C
 - Humidity range: 10% to 85 % RH (Max.), non condensing
 - Operating altitude: 10,000 ft. maximum
- Use only the AC power cord supplied. Do not attempt operation if the AC supply and cord are not within the specified voltage and power range for your region.
- Remove the lens plug from the lens opening in the projector before installing the lens. Retain the lens plug to protect the optical components from dust and debris during transport.
- Do not block the ventilation slots and openings on the projector.
- Do not use abrasive cleaners, waxes or solvents to clean the projector.
- Do not allow anything to rest on the power cord.

2. INTRODUCTION

The product specified in this document is a high brightness, high-resolution video/graphics 1-chip lamp based projector. The projector is available in HD and WUXGA resolutions. The projector utilizes Digital Light Processing (DLP®) technology from Texas Instruments. It is primarily designed for fixed installation markets.

2.1 Projector Components

Front View

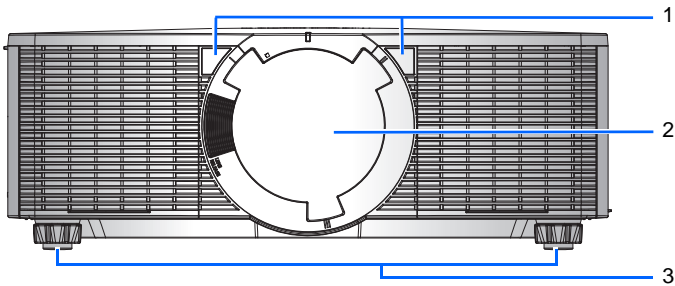

Ind.	Part Name	Description
1	Front IR Sensor	Receive signals from the IR remote. Keep the signal path to the sensor unobstructed for uninterrupted communication with the projector.
2	Projection Lens	Allow automated lens control and adjustment: vertical and horizontal offsets, zoom and focus.
3	Adjustable Feet	Raise or lower the feet to level the projector.

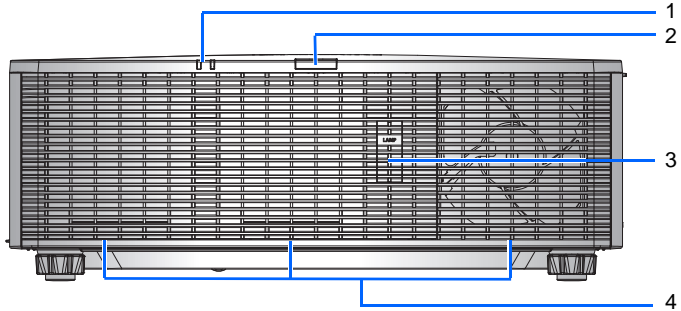
Rear View

Ind.	Part Name	Description
1	LED status Indicators	Display the status of the projector. They are (from left to right): LAMP1, LAMP2.
2	Rear IR Sensor	Receive signals from the IR remote. Keep the signal path unobstructed for uninterrupted communication with the projector.
3	Lamp Door	Use the lamp door to access the lamp module.
4	Cooling Air Vents (Exhaust)	Keep these vents unobstructed to prevent the projector from overheating.

Left View

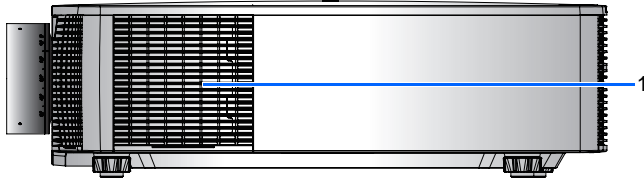

Right View

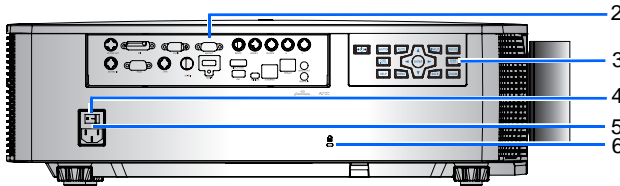

Ind.	Part Name	Description
1	Cooling Air Vents (Intake)	Keep these vents unobstructed to prevent the projector from overheating.
2	Input/Output (I/O) Panel	Connect the projector to external devices.
3	Built-in Keypad	Control the projector.
4	Power Button	Switch the power button to turn on the power source.
5	AC Input	Connect to the supplied power adapter.
6	Kensington Lock	Use to secure the projector to countertops, tables, and so on.

2.2 Built-in Keypad

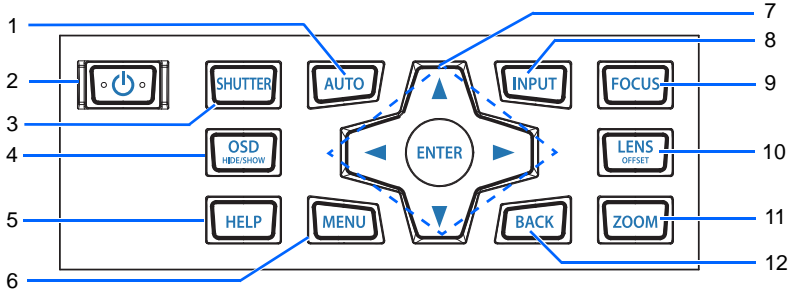

Ind.	Part Name	Description
1	Auto	Automatically optimize image.
2	Power	Turn the projector on or off.
3	Shutter	Display or blank the video image.
4	OSD	Use to hide or show OSD menus.
5	Help	Display the instruction for source connection.
6	Menu	Display menus.
7	Arrow keys	<ul style="list-style-type: none"> Adjust a setting UP or DOWN Navigate within a menu
8	Input	Select an input for the main or PIP/PBP image.
9	Focus	Adjust focus.
10	Lens	Adjust the lens vertical or horizontal offset setting.
11	Zoom	Adjust zoom.
12	Back	Return to previous level or exit menus if at top level.

2.3 Input/Output (I/O) Panel

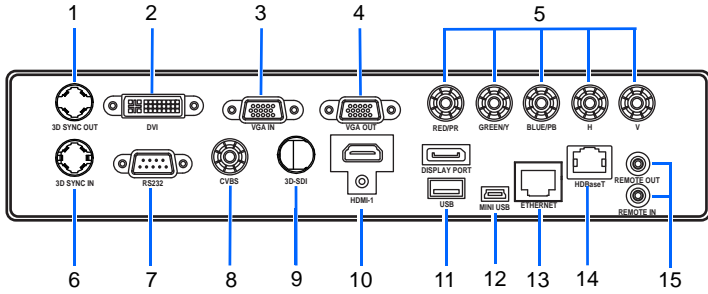

Ind.	Connector Name	Ind.	Connector Name
1	3D Sync OUT	9	3G-SDI
2	DVI-D	10	HDMI-1
3	VGA IN	11	USB
4	VGA OUT	12	MINI USB
5	Component IN	13	Ethernet
6	3D Sync IN	14	HDBaseT
7	RS232	15	Remote OUT/IN
8	CVBS		

2.4 Remote Control

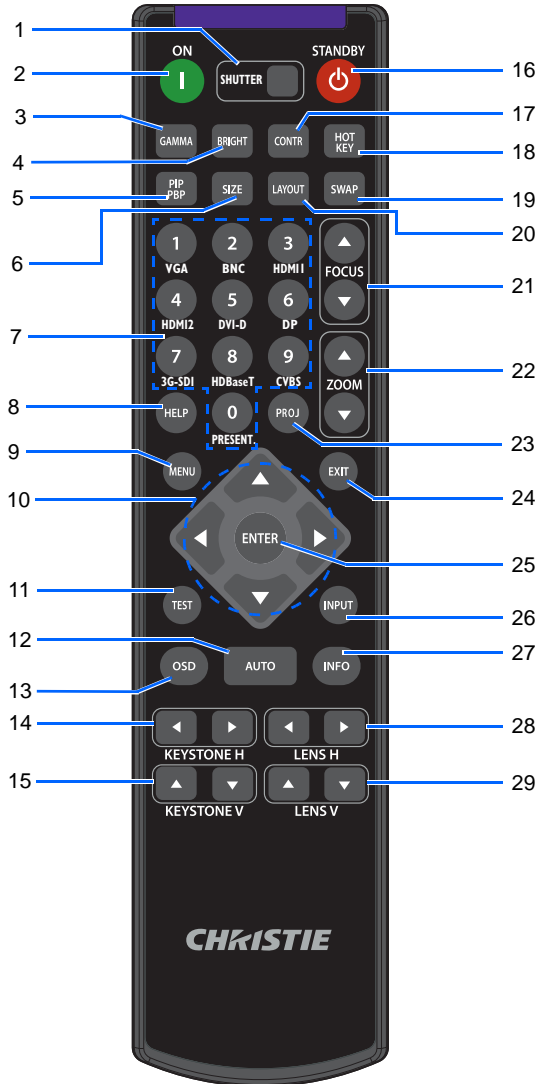

Use a cable length of 20 m or less, if the length of cable exceeds 20 m, the remote control may not work normally.

Ind.	Part Name	Description
1	SHUTTER	Display or blank the video image.
2	Power on	Turn projector ON.
3	Gamma	Adjust mid-range levels.
4	Bright	Adjust amount of light in the image.
5	PIP/PBP	Turn PIP/PBP ON/OFF.
6	Size	Adjust the PIP/PBP size.
7	Number Keys	Enter a number, such as a channel, value, and so on.
8	Help	Display the instruction for source connection.
9	Menu	Display menus.
10	Arrow Keys	<ul style="list-style-type: none"> Adjust a setting UP or DOWN. Navigate within a menu.
11	Test	Display a test pattern.
12	Auto	Automatically optimize image.
13	OSD	Use to hide or show OSD menus.
14	Keystone H	Adjust the horizontal keystone.
15	Keystone V	Adjust the vertical keystone.
16	Standby	Turn projector OFF.
17	Contrast	Adjust difference between dark and light.
18	Hot-key	Select your preset keys quickly.
19	Swap	Swap the main and PIP/PBP images.
20	Layout	Adjust the PIP/PBP layout.
21	Focus	Adjust focus to improve image clarity as desired.
22	Zoom	Adjust zoom to achieve a desired image size.
23	Proj Key	Change the remote ID. Press Proj Key then a number between 1 and 9 to assign an ID. Press PROJ then number 0 to return to the universal remote ID.
24	Exit	Return to previous level or exit menus if at top level.
25	Enter	<ul style="list-style-type: none"> Select a highlighted menu item. Change or accept a value.
26	Input	Select an input for the main or PIP/PBP image.
27	Info	Display source image information.
28	Lens H	Horizontal Lens Shift - Adjust the position of the image horizontally.
29	Lens V	Vertical Lens Shift - Adjust the position of the image vertically.

2.5 LED Status Indicators

The LED status indicators are located on the right side of the projector. Each LED is defined below.

- LAMP LED

LED Status	Projector State
Red (Short blink)	Fail to strike lamp after attempts. (Strike attempts stop.)
Red (Solid)	Lamp has unexpectedly shut down. (System goes into cool down state.)
Yellow (Solid)	Lamp time has expired and lamp should be replaced. (Projector also begins to display the replaced lamps OSD message at startup.)
Green (Solid)	Lamp is on and operating correctly.
Green (short blink)	Projector lamp is switching on.
Off	Lamp is off.

- STATUS LED

LED Status	Projector State
Off	AC power is off (without AC plug in).
Green (Flashing)	Projector is startup or in cool down mode.
Green (Solid)	System is operating stably.
Blue (Flashing)	Projector is cooling down.
Blue (Solid)	AC has been applied, projector is in standby mode.
Yellow (Flashing)	Warning is an attention state that does not cause the projector to shutdown. The dynamic black error or entering high altitude mode is due to over temperature of lamp driver.
Yellow (Solid)	Projector is turning off by the end user while projector is warning.
Red (Flashing)	Error is an attention state that has caused or may inevitably cause projectore shutdown. (Fan failure, over temperature, Fliter install Failure, CW Failure.)
Red (solid)	Projector is turning off by the end user while projector is warning.
White (Flashing)	Projector is in flash(LAN) update state.

- SHUTTER LED

LED Status	Projector State
Off	Lamp is on - image is displayed
Magenta (Solid)	Lamp is on - image is blank

3. INSTALLATION

3.1 Connect to Computer

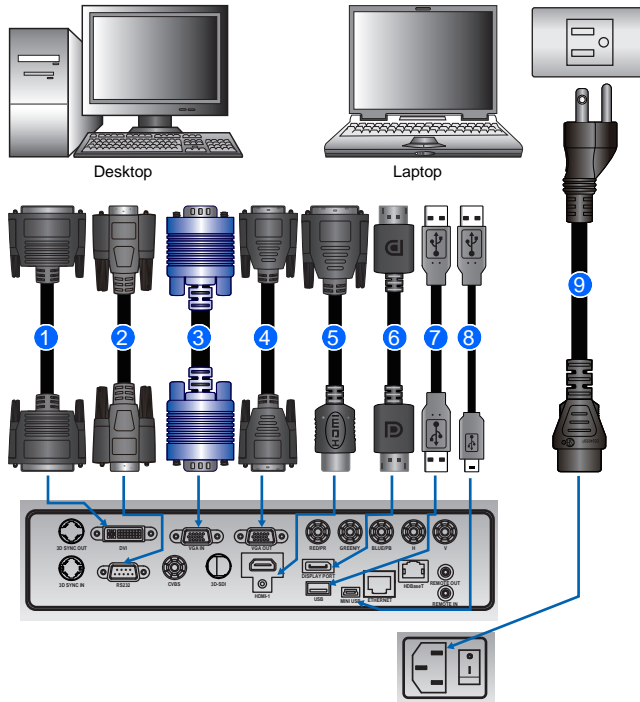

Ind.	Connector Name	Ind.	Connector Name	Ind.	Connector Name
1	DVI Cable	4	VGA out Cable	7	USB Type A Cable
2	RS232 Cable	5	HDMI Cable	8	USB Type B Mini Cable
3	VGA in Cable	6	DisplayPort Cable	9	Power Cord

NOTE:

- ❖ *The diagram shows the cables/connectors that may be used to connect to various devices.*
- ❖ *Due to the difference in applications for each country, the accessories required in some regions may be different from those shown.*
- ❖ *This diagram is for illustrative purposes only, and does NOT indicate that these accessories are supplied with the projector.*

3.2 Connect to Video Equipment

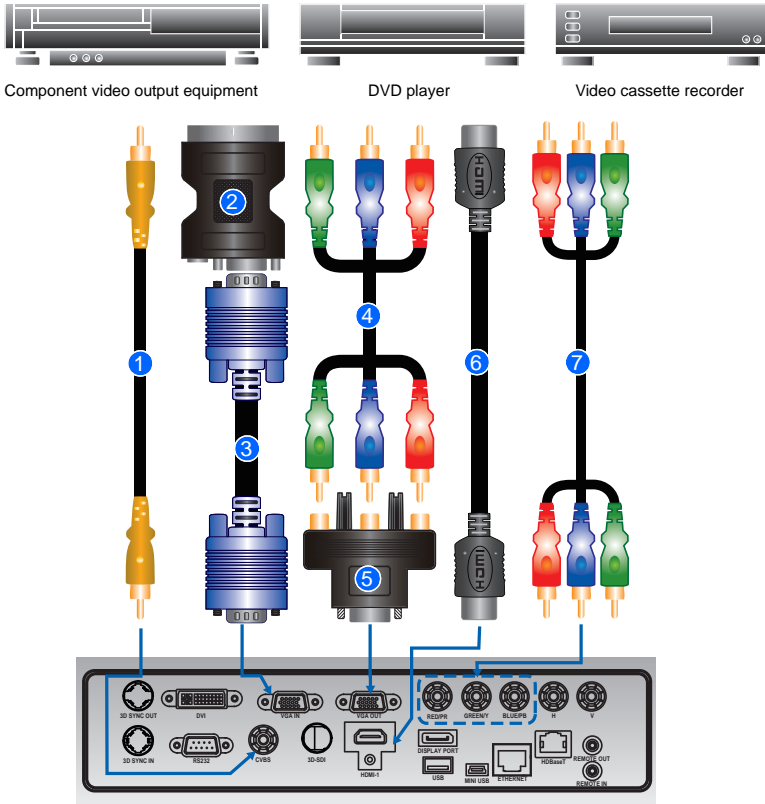

Ind.	Connector Name	Ind.	Connector Name
1	CVBS Cable	5	15-pin to 3 RCA Component/HDTV Adapter
2	VGA to RGB SCART	6	HDMI Cable
3	VGA in Cable	7	Component (YPbPr) Cable
4	3 RCA Component Cable		

NOTE:

- ❖ The diagram shows the cables/connectors that may be used to connect to various devices.
- ❖ Due to the difference in applications for each country, the accessories required in some regions may be different from those shown.
- ❖ This diagram is for illustrative purposes only, and does NOT indicate that these accessories are supplied with the projector.

3.3 Turn the Projector On

1. Ensure that the power cord and signal cable are securely connected. The Power button on the built in keypad is illuminated.
2. Turn on the projector by pressing "ON" on the remote control or press "⏻" on the built-in keypad. The Status LED is Green with a long blink.
3. Turn on the source. Select Input Key on the remote control to select an input source (VGA, BNC, HDMI, Component, S-Video or Composite Video).
4. The projector detects the source you selected and displays the image.

NOTE:

- ❖ *The first time the projector is used, the preferred language may be selected from the main menu after the startup screen is displayed.*

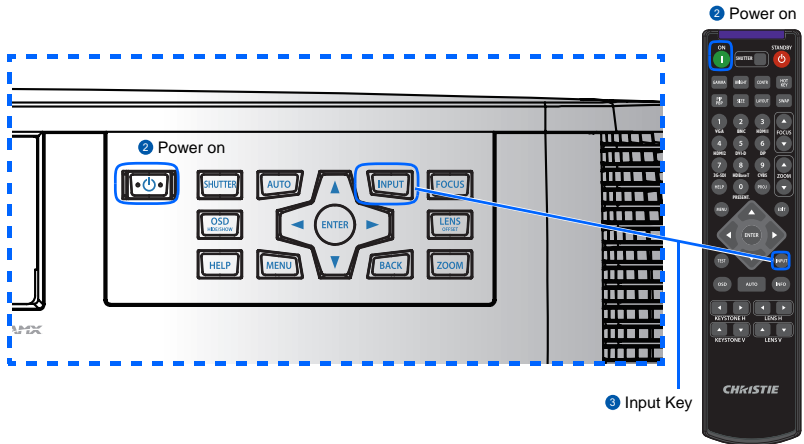

3.4 Turn the Projector Off

1. Press "⏻" on the built-in keypad or on the remote control to turn off the projector. A warning message appears on the displayed image.
2. Press "⏻" again to confirm your selection. If you do not press "⏻" again, the warning message disappears after three seconds.

3.5 Adjust the Projector Position

When you select a position for the projector, consider the size and shape of your screen, the location of your power outlets, and the distance between the projector and the rest of your equipment. Follow these general guidelines:

- Position the projector on a flat surface at a right angle to the screen. The projector (with the standard lens) must be at least 3 feet (0.9m) from the projection screen.
- Position the projector to the required distance from the screen. The distance from the lens of the projector to the screen, the zoom setting, and the video format determine the size of the projected image.
- For the fixed short lens, the image exits at a default angle. However, the lens shift feature makes the image offset variable.
- Lens throw ratio:
 - Lens 1.2~1.5 (WU/HD)
 - Lens 1.5~2.0 (WU/HD)
 - Lens 2.0~4.0 (WU/HD)
- 360 degree operation (along the widest axis)

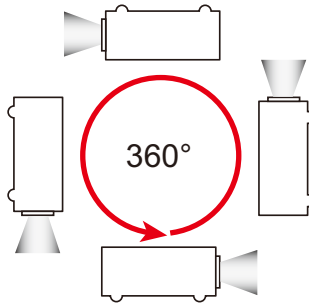

NOTE:

- ❖ *The max tilt of lamp axis from horizontal is ± 20 degrees.*

Portrait Mode

- The projector is in portrait mode when the viewing angle is from 70° to 110° as illustrated below.

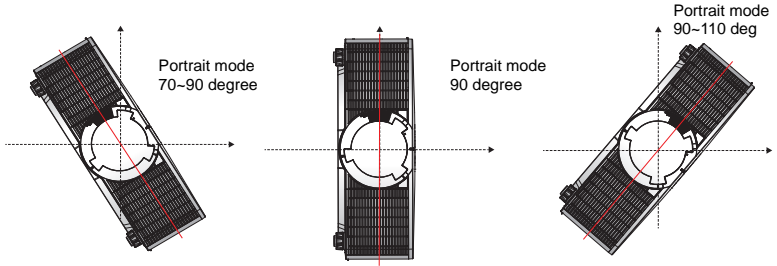

Non-Supported Modes

- The projector is in non-portrait mode when the viewing angle is 250° to 290° as illustrated below.
- The "red" status LED on projector lights on.

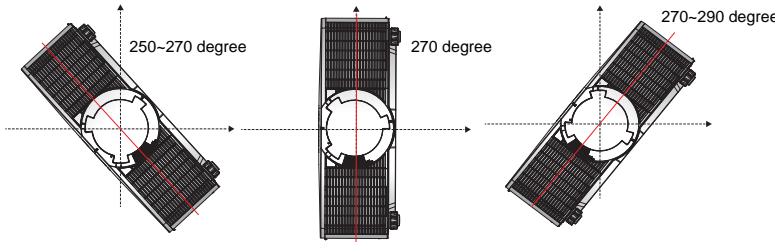

⚠ WARNING

- The projector should not be operated in Non-Portrait Mode.

3.6 Calculate Lens Offset

- The vertical image offset (shift) ranges for the projector are +/-120% (WUXGA) and +/-140% (HD). The horizontal image offset (shift) range for the projector is +/-50% (HD/WUXGA).
- The method for calculating lens offset complies with Industry standards.
Example for Vertical lens offset:
 - At 0% offset (or on axis), the center of the image is on the lens center, so that half of the image appears above and half appears below the lens center.
 - At +100% offset, all (or 100%) of the image appears above the lens center.
 - The % offset is calculated as the ratio of the number of pixels shifted up/down to half the image size. Examples for WUXGA:
 - ▶ Shifting up 600 pixels gives offset of $600/600 * 100\% = 100\%$
 - ▶ Shifting down 600 pixels gives offset of $-600/600 * 100\% = -100\%$
 - ▶ Shifting up 720 pixels gives offset of $720/600 * 100\% = 120\%$
 - ▶ Shifting up 240 pixels gives offset of $240/600 * 100\% = 40\%$

WUXGA Projectors:

Vertical Image Offset: 0% Offset (WUXGA)

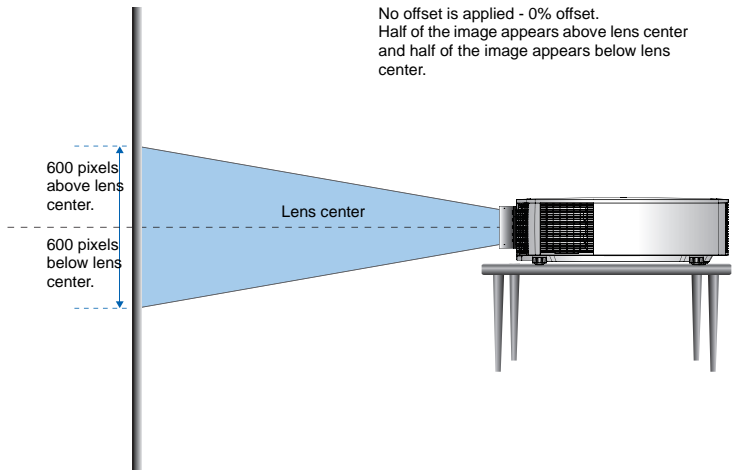

Vertical Image Offset: 120% Offset (WUXGA)

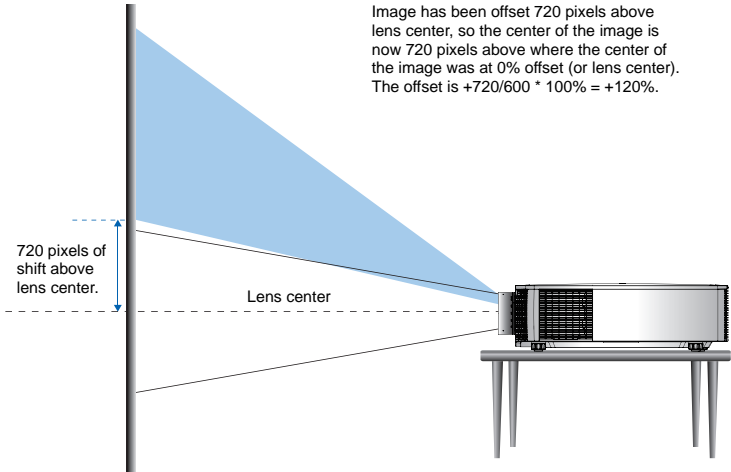

Vertical Image Offset: -120% Offset (WUXGA)

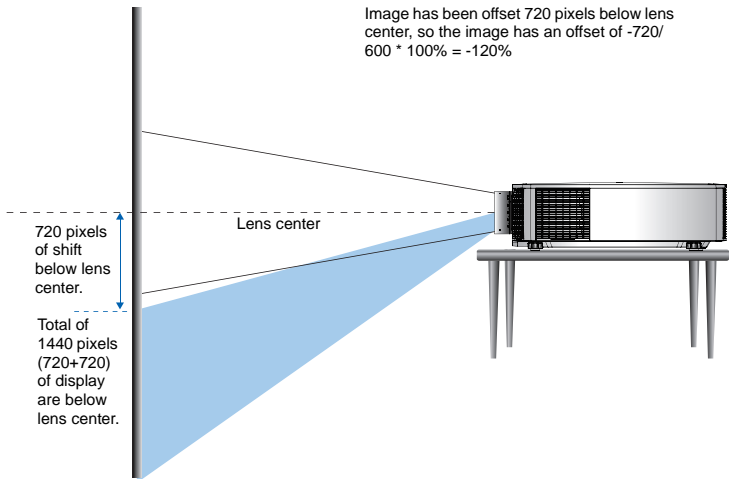

HD Projectors:

Vertical Image Offset: 0% Offset (HD)

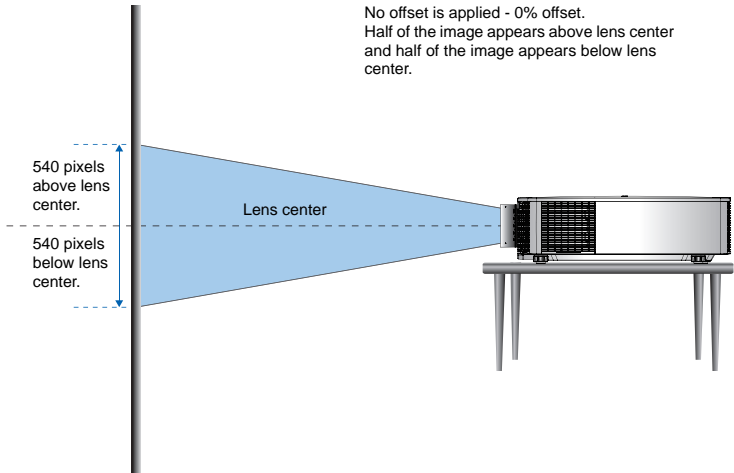

Vertical Image Offset: 140% Offset (HD)

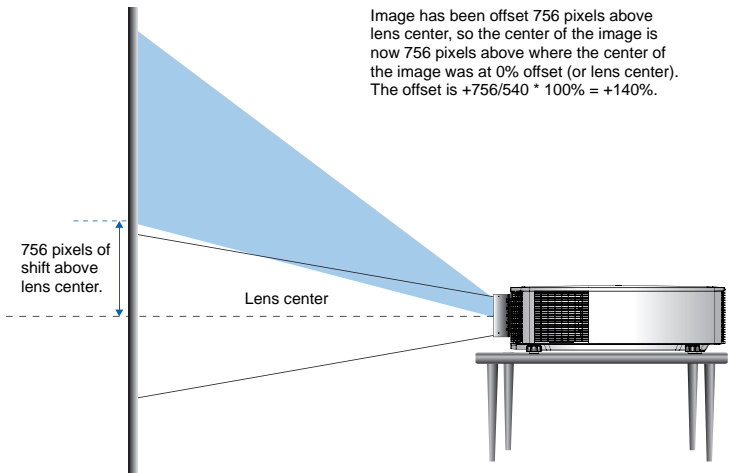

Vertical Image Offset: -140% Offset (HD)

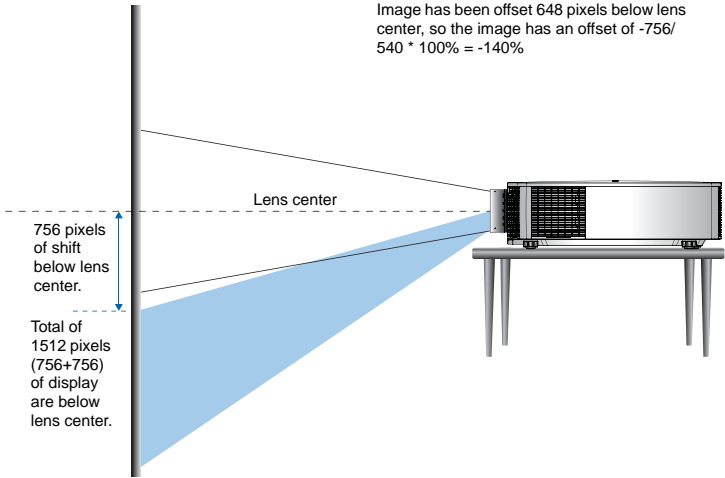

Horizontal Image Offset: +/-50% Offset

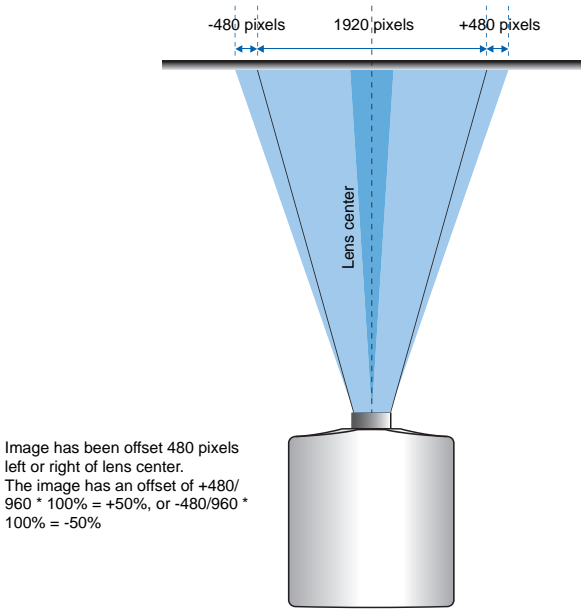

3.7 Removing and Installing the Lens

When handling the projector after lens installation, make sure the front lens cap is placed on the lens to protect the lens surface from potential damage. When carrying or moving the projector, do not handle by the lens. This may damage the lens, the chassis or other mechanical parts within the projector.

Installation Steps:

1. **Center the lens:** Ensure that the lens is at or near its center position. Attempting to remove the lens when at a large offset may cause damage to the lens assembly. Center the lens while the projector is switched on by pressing the lens horizontal or vertical button and then pressing Enter.
2. **Turn Off the projector:** Turn the projector OFF.
3. **Wait for projector to cool down:** Allow the projector to cool down into standby mode before replacing the lens. Remove power cord after the projector has cooled down and prior to replacing the lens.
4. **Remove the lens:** Press lens release button and rotate the lens counter-clockwise by a quarter to release the lock. Remove the lens through the front of the projector.

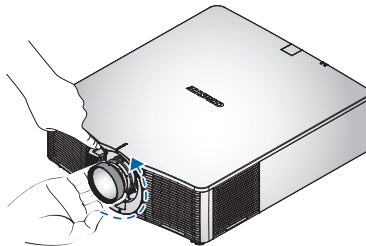

5. **Install the new lens:** Fully insert the lens assembly straight into the lens mount without turning. Rotate the lens cap clockwise to lock the lens in place.

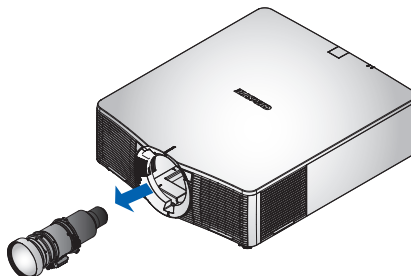

3.8 Fuse Installation

1. Turn off the projector: Turn the projector off.
2. Wait for projector to cool down: Allow the projector to cool down into standby mode.
3. Take off rear fan cover by releasing one screw on the cover.
4. Release the fuse and replace the new one.

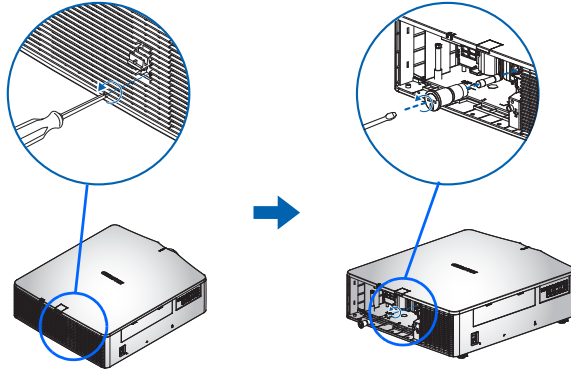

NOTE:

- ❖ For high rating region (200~240v), it should use a 10 amp or 15 amp fuse.
- For low rating region (100~120v), it should use a 20 amp or 15 amp fuse.

3.9 Filter Replacement

1. Turn off the projector.
2. Wait for projector to cool down: Allow the projector to cool down into standby mode.
3. Remove the filter cover by pushing down it.
4. Release the filter by pulling out and replace it.

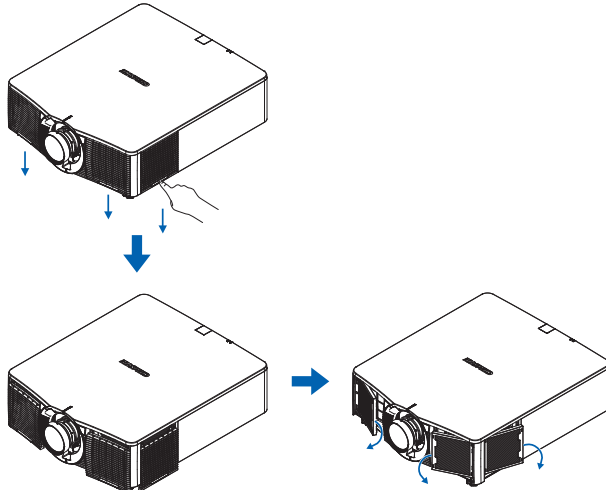

3.10 Ceiling Mount Installation

Mount the projector with an appropriate mounting kit, using the four mounting points on the underside of the projector.

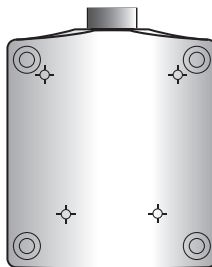

- When not mounted properly, the projector may fall, causing hazards or injury. The warranty on this projector does not cover any damage caused by the use of any non-recommended ceiling mount kit or installation of the ceiling mount kit in an improper location.
- Refer to the installation instructions and safety guidelines provided in the kit.

4. OPERATION

The projector has multilingual On-Screen Display (OSD) menus that allow you to make image adjustments and change a variety of settings.

- Most of the projector controls are accessed from within the projector menu system. There are several groups of related functions, with each group selectable from the Main menu as shown below. Press the MENU button on the remote control or on the built-in keypad on the rear of the projector to display the main menu.
- Use the arrow keys to navigate within the menu and adjust a setting up or down.
- Press ENTER to select a highlighted menu item or use it to change or accept a value.
- Select the next item that you want to adjust in the menu and adjust it as described above.
- Press EXIT to return to the previous menu or exit menus if at top level.

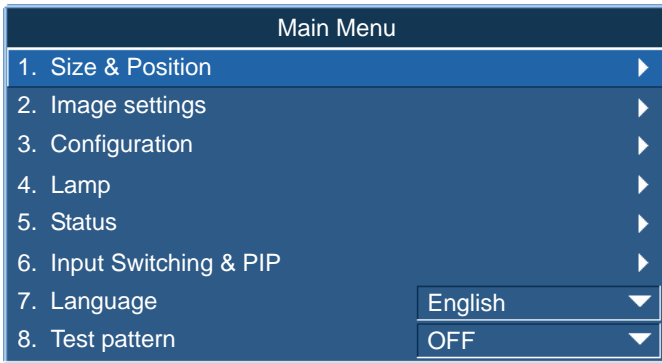

4.1 Size and Position Menu

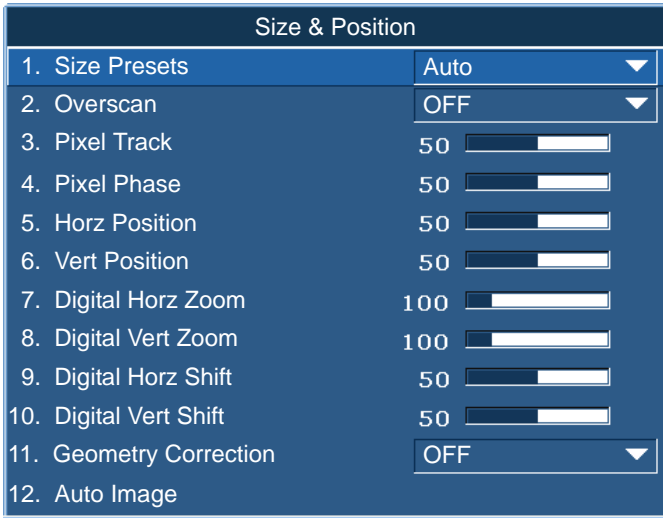

Size Presets

Display an image with the detected size, or resize the image by maximizing either the height, width or both, or resize to the maximum size possible while keeping the original aspect ratio.

- Auto: Display with the detected size.
- Native: Display in its native resolution.
- 4:3: Retain 4:3 aspect ratio.
- Letterbox: Make the active content enlarge to the full screen.
- Full Size: Fill the screen (regardless of the source).
- Full Width: Fill display width and keep aspect ratio.
- Full Height: Fill display height and keep aspect ratio.
- Custom: Stretch the display horizontally or vertically without cutting the image display.

Overscan

Remove noise around the image. Overscan Zoom enlarges image 6% from original size. Overscan Crop cuts 6% of active pixels in four edges of original image.

Pixel Track

Analog RGB signals only. Steady flickering or several soft vertical stripes or bands across the entire image indicates poor pixel tracking. Proper pixel

tracking ensures that the image quality is consistent across the screen, the aspect ratio is maintained, and that the pixel phase can be optimized.

Pixel Phase

Analog RGB Signals only. Adjust pixel phase when the image still shows shimmer or noise after pixel tracking is optimized. Pixel phase can adjust the phase of the pixel-sampling clock relative to the incoming signal.

Horz Position

Move the image right or left within the area of available pixels.

Vert Position

Move the image up or down within the area of available pixels.

Digital Horz Zoom

Change the size of projector's display area horizontally. If the display area has been resized by this setting, it can be moved by changing the Digital Horz Shift and Digital Vert Shift settings.

Digital Vert Zoom

Change the size of projector's display area vertically. If the display area has been resized by this setting, it can be moved by changing the Digital Horz Shift and Digital Vert Shift settings.

Digital Horz Shift

Move the display area horizontally if its size has been changed by the Digital Zoom setting.

Digital Vert Shift

Move the display area vertically if its size has been changed by the Digital Zoom setting.

Geometry Correction

Provides two ways for warping control.

1. PC Mode off:

User can do simple horizontal/vertical keystone, pincushion, barrel control by using OSD.

2. PC Mode on:

User can do arbitrary warping or blending control by using PC APP provided separately.

Geometry Correction Feature Compatibility

Warp Function	4-Corner	Curved Surface(2x2)	Keystone	Pincushion and Barrel	Rotation
4-Corner	--	✓	✓	✓	✓
Curved Surface(2x2)	✓	--	X	X	X
Keystone	✓	X	--	✓	X
Pincushion and Barrel	✓	X	✓	--	X
Rotation	✓	X	X	X	--

- OFF: No Geometric correction is applied to the image.
- Horiz Keystone: Adjust the keystone horizontally to make the image more square. Horizontal keystone is used to correct a keystoneed image shape in which the left and right borders of the image are unequal in length, and the top and bottom are slanted to one of the sides. This is intended for use with horizontally on-axis applications. For horizontally offset applications, you must use four Corner correction using the optional Dual Processor Warp Module.

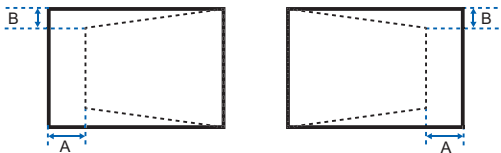

Ind.	1080P	WUXGA
A	30.60%	30.34%
B	14.20%	12.86%

- Vert Keystone: Adjust the keystone vertically to make the image more square. Vertical keystone is used to correct a keystoneed image shape in which the left and right borders of the image are unequal in length, and the top and bottom are slanted to one of the sides. This is intended for use with horizontally on-axis applications. For horizontally offset images, you must use four Corner correction using the optional Dual Processor Warp Module.

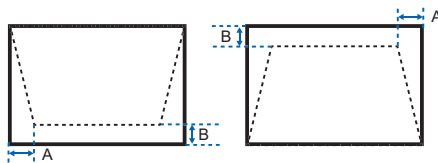

Ind.	1080P	WUXGA
A	5.12%	5.04%
B	11.00%	10.52%

- Horiz Pincushion: Adjust the pincushion horizontally and make the image more square.

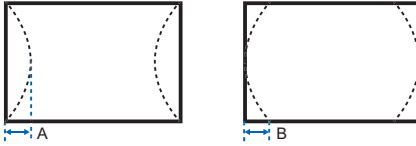

Ind.	1080P	WUXGA
A	5.17%	5.39%
B	5.17%	4.24%

- Vert Pincushion: Adjust the pincushion vertically and make the image more square.

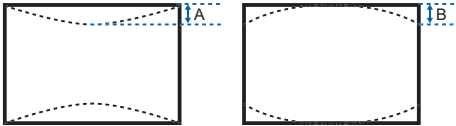

Ind.	1080P	WUXGA
A	9.67%	7.44%
B	9.83%	7.58%

- Pincushion/Barrel: Allow for correction for slight curved distortion from the lens or projection surface

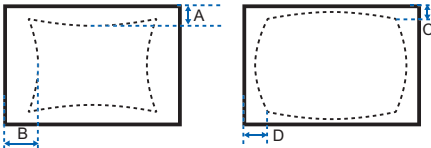

Ind.	1080P	WUXGA
A	9.19%	7.44%
B	5.28%	5.39%
C	8.65%	6.87%
D	3.76%	3.36%

Auto Image

Force the projector to reacquire and lock to the input signal. This is useful when signal quality is marginal. "Normal mode" can support all of the 4:3 input sources.

"Wide mode" can support all of the 16:9 input source & most of the 4:3 input source. For those 4:3 input sources not recognized by "Wide mode" (for example 1400 x 1050), perform Auto Image using "normal mode".

4.2 Image Settings Menu

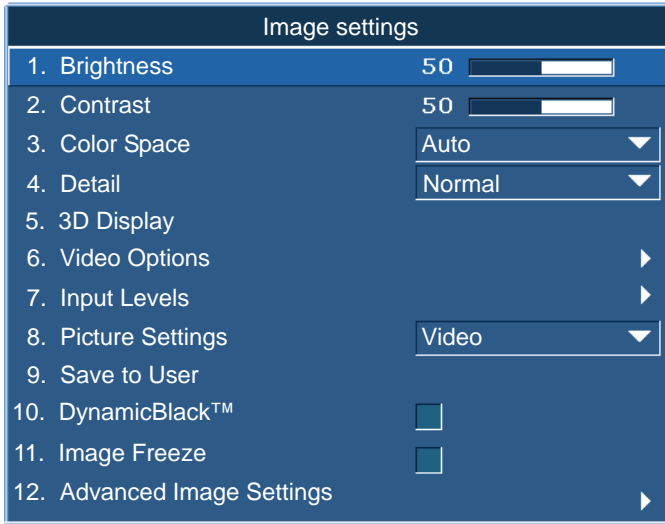

Brightness

Adjust the intensity of the image.

Contrast

Adjust the degree of difference between the lightest and darkest parts of the picture and change the amount of black and white in the image.

Color Space

Select a color space that has been specifically tuned for the input signal. Useful only for analog signals and certain digital sources.

Detail

Select the edge clarity of the image.

3D Display

Select the 3D relating settings,

- 3D Enable: Set 3D format. Supports Mandatory 3D formats and frame sequential 3D@120Hz.
- 3D Invert: Invert 3D sync signal for the application of using single projector.
- Toggle 3D Blending: Invert 3D sync signal for the application of using multiple projectors for 3D blending.

Video Options

This function is used with video sources only.

- **Color:** Adjust a video image from black and white to fully saturated color. The color setting applies to video sources only.
- **Tint:** Adjust the red-green color balance in the image of NTSC video images. The tint setting applies to NTSC video sources only.
- **Noise Reduction:** Reduce temporal or spatial noise in the image.
- **Flesh Tone Correction:** Control the amount of flesh tone correction applied to the image.
- **Video Black Level:** Analyze the current input image and calculate an offset value which is then added to the analog to digital converter black level value. This ensures optimum black level for each analog source.
- **Detect Film:** Control film mode detection and determine whether the original source of the input video was film or video.
- **Closed Captions:** Control closed caption display while audio is not muted.
- If this setting is not off, audio is not muted, the source is NTSC and contains captions on the selected channel, then the projector must display caption text overlaid on the image.

Input Levels

VGA / Component signals only.

- Adjust the gain of the red, green, or blue channel of the image. It affects the black and white.
- Adjust the offset of the red, green, or blue channel of the image. It affects the black and white.
- **Sync Threshold:** (progressive signals only) If a hardware device, such as a DVD player, is not syncing properly with the projector, select this option to help it to sync when connecting to the projector.

Picture Settings

Optimize the projector for displaying images under certain conditions, such as presentation, video, bright, real, dicom sim, and user-definable preset. It affects Gamma, Sharpness, White Peaking, Overscan, Brightness, Contrast, Color, Tint, Red Gain, Green Gain, Blue Gain, Red Offset, Green Offset, Blue Offset.

Save to User

Adjust the image settings and select Save to User as a picture setting. You can recall these settings in the future by selecting the User in the Picture Settings menu. The setting of Brightness, Contrast, Color, Tint, Red Gain, Green Gain, Blue Gain, Red Offset, Green Offset, Blue Offset, Color Temperature, Gamma, Detail, White Peaking and Overscan can be saved.

DynamicBlack™

Enable or disable the dynamic black function. Enable this function to raise the contrast ratio dynamically.

Image Freeze

Pause the screen image.

Advanced Image Settings

- **Gamma:** Select the appropriate gamma from Video, Film, Bright, CRT, and DICOM.
- **White Peaking:** (video source only) Increase the brightness of whites that are near 100%.
- **Color Temperature:** Change the intensity of the colors. Select a listed relative warmth value.
- **Edge Enhancement:** Apply the edge enhancement process.

4.3 Configuration Menu

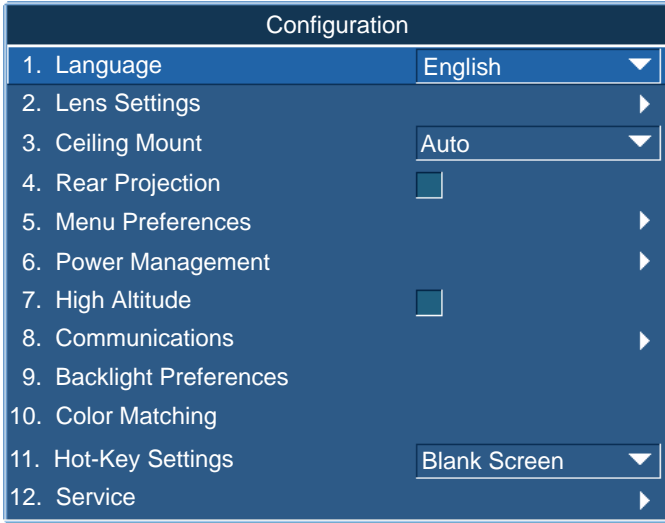

Language

Allow you to select an available language for the OSD display, from English, French, German, Italian, Spanish, Chinese(simplified), Japanese, Korean, and Russian.

Lens Settings

- Focus and Zoom: Adjust the focus and zoom the image in or out.
- Lens Shift: Shift the lens up and down or left and right.
- Lock all Lens Motors: Select this function to prevent all lens motors from moving. It may disable the Zoom, Focus, Horizontal and Vertical Position settings, effectively locking out any changes and overriding all other lens features. This is particularly useful to prevent accidental lens position changes in multi-projector installations.
- Lens Calibration: Calibrate the lens center.

Ceiling Mount

Turn the image upside down for ceiling-mounted projection.

Rear Projection

Reverse the image so you can project from behind a translucent screen.

Menu Preferences

- Menu Horz Offset: Change the horizontal position of the OSD.
- Menu Vert Offset: Change the vertical position of the OSD.
- Show Messages: Display status messages on the screen.
- Menu Transparency: Change OSD menu background to be transparent.

NOTE:

❖ *As the value increases, more of the image behind the menu is visible.*

- Splash Screen Setup: Choose which splash screen is to be used.
- PIN Protect: The PIN (personal identification number) feature allows you to password protect your projector. Once you enable the PIN feature, you must enter the PIN before you can project an image.
- Change PIN: Allow you to change the PIN.

Power Management

- Standby Mode: The projector is in standby mode when connecting to AC power. (<0.5W)
- AC Power On: The projector automatically turns on when electrical power is connected.
- Auto Shutdown: The projector automatically turns off after no signals are detected for a preset number of minutes. If an active signal is received before the projector powers down, the image will be displayed.
- Sleep Timer: Allow the projector to automatically power off after it has been on for a specified amount of time (2, 4, or 6 hours).

High Altitude

Set high altitude mode ON/OFF. When it is ON, the fan operates at high speed to ensure sufficient air flow for high altitudes.

Communications

- Network: Allow you to setup network settings.
 - DHCP: Turn the DHCP ON/OFF.
 - IP Address: Assign Network IP Address.
 - Subnet Mask: Assign Network Subnet Mask.
 - Default Gateway: Assign Network Default Gateway.
 - Host Name: Display the host name.
 - MAC Address: Display network MAC Address value.
 - Show Network Messages: Turn network messages ON/OFF.
 - Restart Network: Restart the network.
 - Network Factory Reset: Perform factory reset on the network settings. The Projector Name, LAN IP, WLAN IP, and SNMP settings can be reset.
- Serial Port Baud Rate: Select the serial port and baud rate.

- Serial Port Echo: Control whether the serial port echoes characters.
- Serial Port Path: Select the serial port path from either RS232 or HDBaseT.
- Projector Address: Set the projector address (0-9). The projector responds to IR remotes set either at the same address as the projector or to IR remotes set to address 0.

Backlight Preferences

Control the back light behavior and timeout setting for the keypad and status LED.

Color Matching

You may require a unique color gamut (range) for a single projector or application, or you may need to precisely match colors across multiple adjacent displays. Use Color Matching by Meter Adjustment or by Manual Adjustment to define the precise hue of each primary color component (red, green, blue and white).

The x/y coordinates for each color define its location on the standard CIE chromaticity graph. Changing either or both of these numbers may change the hue of the color, and modify the range of possible colors. For example, changing the x/y coordinates for red may move the color closer to orange or closer to violet, which in turn affects all displayed colors having a red component. Adjust the slide bars or enter new specific coordinates as desired to define or change the color gamuts needed for your environment and applications.

Enable the selected method (Meter or Manual Adjustment)-this automatically disables the other method. For both methods, if Auto Test Pattern is enabled, the solid colored test pattern can be displayed according to the menu item on which you are positioned.

- Meter Adjustment
 - 1 Using a color meter, enter the current x and y co-ordinates of Red, Green, Blue and White for the projector image into the Measured Data menu. This is the reference point for the projector. The default values in the menu are based on the average for all projectors.
 - 2 After measuring the values for all the projectors to be matched, calculate the target values.
 - 3 Enter the target values for x, y and gain for each color into the Target Data menu.

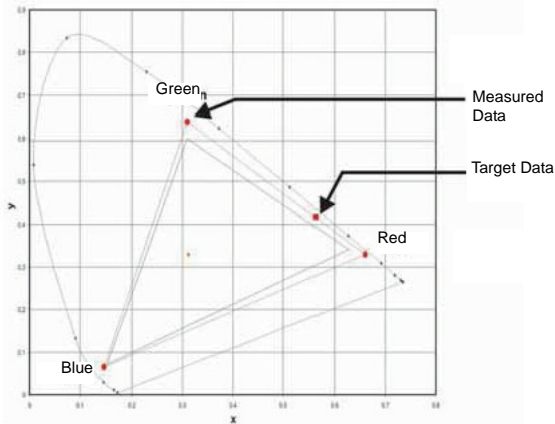

- Manual Adjustment
 - 1 Adjust color slide bars and judge image color by eye or meter. A user-defined color "adjustment" can be applied.
 - 2 Use this submenu if you do not have specific color coordinates in mind and will judge color performance by eye or meter. As for Meter Adjustment, each color control actually defines new x/y coordinates for that color and changes its hue. The main colors (red part of red, green part of green and blue part of blue) adjust the intensity of that color component, while the modifying colors (for example, green part of red and blue part of red) modify the x and y value and change the hue of that color. At the same time, the main colors are also used to control the color of the white point.

Hot-Key Settings

Assign a different function to the hot-key on the remote control by highlighting the function in the list and pressing ENTER. Choose a function that does not already have a dedicated button, and assign the hot-key to that function, allowing you to quickly and easily use the chosen function.

Service

- Projector Info: Display current projector settings (read-only).
- Factory Reset: Restore all settings to their default value. It does not reset network but it resets RS232.
- Test Pattern: Choose the desired internal test pattern to display, or select OFF to turn off a test pattern.
- Color wheel Index (2x): Set Color wheel index to Speed 2X. This setting only needs to be used when the Main Board is changed, and should be adjusted to optimize picture quality.

- Color wheel Index (3x): Set Color wheel index to Speed 3X. This setting only needs to be used when the Main Board is changed, and should be adjusted to optimize picture quality.
- Error log: Show the projector error log for debug.
- Mode Adjustment: Fine tune the H and V start position for a signal in the EDID timing table and record the values in the system to override the timing table. The settings must be "Saved to Record" before exiting the menu, or they will be lost. To revert to original timing table settings, each setting must be manually cleared. Factory Defaults will not clear these override settings.
- High temperature warning: Show the warning message when the ambient temperature is over 35°C.
- DA Mode: DA mode helps user to fine tune the DA offset if it is biased according to serious vibration, heavy dust or improper operation.
 - 1 DA offset
Manually adjust the DA offset to get the correct aperture. User can change the value of slide bar and observe the projecting image. Find the value corresponding to the maximum brightness. Recommended value would be within 10~16.
 - 2 DA calibration
This is the general switch to enable the advanced DA offset calibration. Enable the advanced algorithm to overcome the DA problems.
 - 3 DA check
Trigger one shot advanced DA offset calibration right away to get the maximum brightness step.
 - 4 Always calibration
With "DA calibration" being enable, operate the advanced DA offset calibration automatically in every startup.
This item can be automatically checked if DA failure has ever been detected.

4.4 Lamp

Lamp	
1. Lamp Mode	Constant Power ▼
2. Constant Power	10 <input type="text"/>
3. Constant Intensity	▶
4. Current Lamp	Both ▼
5. Lamp Auto Switch	
6. Lamp Auto Switch Time	
7. Lamp Info	▶
8. Lamp Life Setting	1500
9. Reset Lamp Hours	
10. Light Sensor	▶

Lamp Mode

Select Constant Power, Constant Intensity or ECO mode. When in ECO mode, the projector will adjust to the lowest fan speed and switch the lamp power to the minimum setting.

Constant Power

Set the value of the lamp power (in Watts).

Constant Intensity

Set the value for the Constant Intensity to maintain constant brightness.

The light sensor monitors the light level and applies more power as the lamp brightness decays naturally over time. When the lamp setting reaches maximum power of 465W, it remains at this setting. Note that the light sensor needs to be calibrated for Constant Intensity mode to work properly. Calibration should be performed again after every lamp change.

Current Lamp

Select which lamp(s) is in use.

NOTE:

- ❖ *A 120 second timed lockout is applied after changing modes before you can change it again.*

Lamp Auto Switch

Control when the projector switches lamps. Options include: on failure only, at power-up, or after a set number of hours.

Lamp Auto Switch Time

Set the number of hours for Lamp Auto Switch.

For example:

1. Lamp conditions: lamp 1 = 50 hours, lamp 2 = 60 hours.
2. Set the current lamp to lamp 1 - the lamp with the lower lamp hour usage.
3. Set the Lamp Auto Switch to After (N) hours and the Lamp Auto Switch Time to 100 hours.
4. When lamp 1 reaches 150 hours, projector automatically switches to lamp 2.
5. When lamp 2 reaches 160 hours, projector automatically switches to lamp 1.

Lamp Info

Display current lamp(s) settings (read-only).

Lamp Life Setting

Set the number of hours for the lamp life warning. At every startup, the lamp hours are checked. If they exceed this value, a lamp replace message appears.

Reset Lamp Hours

Reset the lamp used hours counter to zero. Do this after changing the lamp.

Light Sensor

Calibrate the Light Sensor for use with the Constant Intensity lamp mode, which allows the projector to be set for constant brightness. If the Light Sensor has not been calibrated, Constant Intensity mode may be disabled. Light Sensor calibration should be repeated when new lamps are installed.

4.5 Status Menu

The read-only Status menu lists a variety of details about the standard and optional components currently detected in the projector.

For DHD Models

Status	
Model Name	D12HD-H
Serial Number	H1YYWWXXX
Native Resolution	1920 x 1080
Firmware	V06.00, A06.20, B02.00
Main Input	VGA 1
Main Signal Format	720p
Main Pixel Clock	74.256MHz
Main Sync Type	Sync on Green
Main Horz Refresh	45.10kHz
Main Vert Refresh	60.0Hz
PIP/POP Input	-
PIP/PBP Signal Format	-
PIP/PBP Pixel Clock	-
PIP/PBP Sync Type	-
PIP/PBP Horz Refresh	-
PIP/PBP Vert Refresh	-
Lamp Power Settings	10
Current Lamp	Both
Lamp 1 Hours	70
Lamp 2 Hours	70
Standby Mode	0.5W Mode
Lens Lock Settings	Allow
IP Address	192.168.0.100
DHCP	<input type="checkbox"/>
System Temperature	38°C (No Filter)

For DWU Models

Status	
Model Name	D12WU-H
Serial Number	H2YYWWXXX
Native Resolution	1920 x 1200
Firmware	V06.00, A06.20, B02.00
Main Input	VGA 1
Main Signal Format	720p
Main Pixel Clock	74.256MHz
Main Sync Type	Sync on Green
Main Horz Refresh	45.10kHz
Main Vert Refresh	60.0Hz
PIP/POP Input	-
PIP/PBP Signal Format	-
PIP/PBP Pixel Clock	-
PIP/PBP Sync Type	-
PIP/PBP Horz Refresh	-
PIP/PBP Vert Refresh	-
Lamp Power Settings	10
Current Lamp	Both
Lamp 1 Hours	70
Lamp 2 Hours	70
Standby Mode	0.5W Mode
Lens Lock Settings	Allow
IP Address	192.168.0.100
DHCP	<input type="checkbox"/>
System Temperature	38°C (No Filter)

4.6 Input Switching & PIP Menu

Input Switching & PIP	
1. Main Input	VGA ▼
2. PIP/POP Input	Card reader ▼
3. PIP/POP Enable	<input checked="" type="checkbox"/>
4. Swap	▶
5. Size	Medium ▼
6. Main Layout	Top Right ▼
7. Timing Detection Mode	
8. Source Info	▶
9. Input key	Auto Source ▼
10. Blank on Signal Switch	<input type="checkbox"/> ▶

Main Input

From the list of active inputs, select one to be used as the main image.

PIP/POP Input

From the list of active inputs, select one to be used as the PIP/PBP.

PIP/POP Enable

Toggle between displaying two sources at once (Main and PIP/PBP images) or one source only. The checkbox turns the PIP/PBP source ON and OFF. Refer to Section 6.2 for the Main and PIP/PBP compatibility table.

Swap

Change the main image to PIP/PBP, and the PIP/PBP to main image. Swapping is available only when PIP/PBP is enabled.

Size

























Select the PIP/PBP size to small, medium or large.

Main Layout

Set the location of the PIP/PBP image on the screen.

NOTE:

- ❖ **PIP/PBP layout and size table as described below.**
- ❖ **P : indicates primary source region (lighter color).**
- ❖ *** : Both source regions are the same size.**

PIP/PBP Layout	PIP/PBP Size		
	Small	Medium	Large
PBP, Bigger Left			
Over-Under, Bigger Upper			
PBP, Bigger Right			
Over-Under, Bigger Lower			
PIP-Bottom Right			
PIP-Bottom Left			
PIP-Top Left			
PIP-Top Right			

Timing Detection Mode

Select timing detection mode to wide or normal. It is used to support additional PC timings. When the projected picture is not completed, this function is used to adjust the picture. "Normal mode" can support all of the 4:3 input sources. "Wide mode" can support all of the 16:9 input source & most of the 4:3 input source. For those 4:3 input sources not recognized by "Wide mode" (for example 1400 x 1050), perform Auto Image using "normal mode".

Source Info

Display current source settings (read-only).

Input key

Use it to list all of the sources or change the sources.

Blank on Signal Switch

When the function is enabled, the projector blanks the screen before timing is stable when changing source.

4.7 Language Menu

Allow you to select an available language for the OSD display.



4.8 Test Pattern Menu

Choose the desired internal test pattern to display, or select OFF to turn off a test pattern.

- OFF
- Black
- White
- Checkerboard
- Grid
- Color Bars

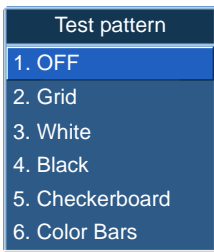

4.9 Web User Interface

4.9.1 Logging On

Open your web browser and type the IP address (in the address bar) assigned to your projector.



- 1 Select the log in level from the Access type list.
- 2 Enter the Password in the Password field.
- 3 Select the appropriate language from the Language list.
- 4 Click the Press login button. The Main window appears.

4.9.2 Main Tabbed Page - General



- Control Panel
Select main source / PIP source, enable/disable PIP/PBP, change the layout / PIP size, swap, and change the test pattern.
- Projector Information Panel
Check the projector information for power status, Pic mute status, OSD status, IP address and Mac address.
- Switch Panel
Switch the on/off status of power, Pic mute, and OSD.

4.9.3 Main Tabbed Page - Status

Display the current status of light source, cooling (fans), version numbers and signal (source) information

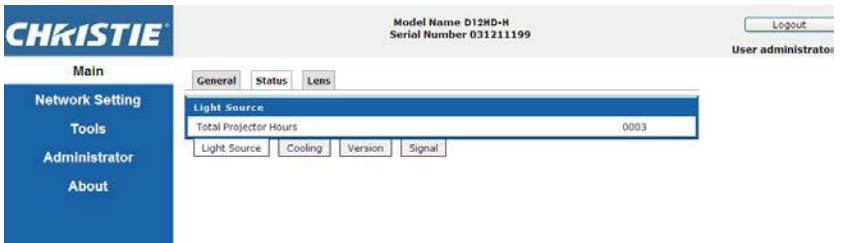

4.9.4 Main Tabbed Page - Lens

Control the focus, lens shift and zoom adjustments for the lens.

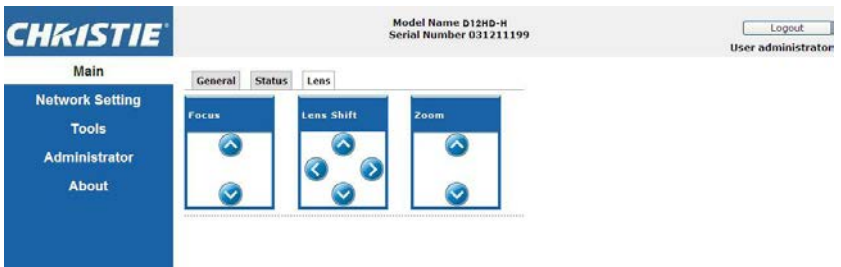

4.9.5 Network

CHRISTIE®

Model Name D12HD-H
Serial Number 031211199

Projector Name:

Show Network Messages: ON OFF

Restart Network...

Network Factory Reset...

User administrator

Main

Network Setting

Tools

Administrator

About

LAN

DHCP Manual

IP Address:

Subnet Mask:

Default Gateway:

MAC Address: 00:70:21:72:0a:cb

WLAN

Enable Disable

Start IP:

End IP:

Subnet Mask:

Default Gateway:

MAC Address: --:--:--:--:--:--

SNMP

SNMP Read Community:

SNMP Location:

Trap IP Address:

Trap Email 1:

Trap Email 2:

Email From Address:

SMTP Server IP Address:

Please press Enter key after modifying

Crestron Control System

IP Address:

IP ID:

Port:

Trap Configuration

Light Source Life:

Light Source Fault:

Fan Stall:

Thermal Sensors:

Power:

Signal Lost/Detected:

NOTE:

- ❖ *If you change the setting, the projector's network subsystem may restart, and you may be logged off.*

4-23

H Series User Manual
020-000772-02 Rev.1 (08-2015)

- Restart Network
Execute a Network restart. This does not change any of the network settings.
- Network Factory Reset
Execute a network factory reset. Network settings may be reset to the following default values:
 - Projector Name = Christie@ + Serial Number
 - Show Network Messages = ON
 - LAN Settings:
 - Manual
 - IP Address = 192.168.0.100
 - Subnet Mask = 255.255.255.0
 - Default Gateway = 192.168.0.100
 - WLAN Settings:
 - Enabled
 - Start IP = 192.168.1.100
 - End IP = 192.168.1.120
 - Subnet Mask = 255.255.255.0
 - Default Gateway = 192.168.1.100
 - SNMP Settings:
 - SNMP Read Communication = private
 - Trap IP Address = 0.0.0.0
 - SMTP IP Address = 0.0.0.0
 - All other settings are cleared/blanked
 - Trap Configuration:
 - All items = SNMP Trap + Email
- LAN Setting Panel
 - Select if the projector must obtain an automatically assigned IP address through DHCP or if the user set the address manually.
 - Enter the IP address, netmask, and default gateway address for the TCP/IP setting.
- WLAN Setting Panel
 - Select if the wireless LAN of the projector is enabled or disabled.

- Enter the IP address range, netmask and default gateway for the wireless LAN.
- **SNMP Panel**
 - The SNMP (Simple Network Management Protocol) interface provides network administrators with a common way to manage their network devices from a single remote location. SNMP allows an administrator to query a number of devices to see their current status/ configuration. It also allows operators to change configuration values and configure trap notifications to be sent when certain events occur. (for example, loss of signal, power state change, and so on)
 - ▶ Emails are sent to the mail server configured in the projector settings. Up to two user email accounts can be selected. Any important information regarding the event is located in the body content of the email.
 - ▶ SNMP Traps are notifications that are sent from the projector. They are only received by a trap receiver (MIB Browser) in the computer.
 - SNMP Read Community (default setting: private) - this is a plain - text password. This must also be entered in the MIB browser. This password allows the various settings in the projector to be queried.
 - SNMP Location (default setting: blank) - This field can be used as a description to where a projector is located in a building. SNMP emails sent will specify this location.
 - Trap IP Address (default setting: 0.0.0.0) - This field must be filled in to receive Traps from the projector. The Trap IP Address should be filled in with the IP Address of the computer on which you would like to view received traps.
 - Trap Email 1/2 (default setting: Blank) - The Trap Email 1 and 2 must be set to an email address that is configured under the mail server that you will enter in the "SMTP Server IP Address" field.
 - Email from Address (default setting: blank) - the "Email from Address" that will appear as the source of the SNMP emails.
 - SMTP Server IP Address (default setting: 0.0.0.0) - Enter your mail server's IP address.
- **Trap Configuration Panel**

Set the SNMP actions for the system events. The options are: SNMP Trap + Email, Email, SNMP Trap, and Disabled.
- **Crestron Control System Panel**

Enter the IP address, IP ID, and Port of Crestron device for connection.

4.9.6 Tools

To Use the Tools tabbed pages to control Size & Position, Image Settings, Configuration, Light Source, Input Switching & PIP and Test Pattern.

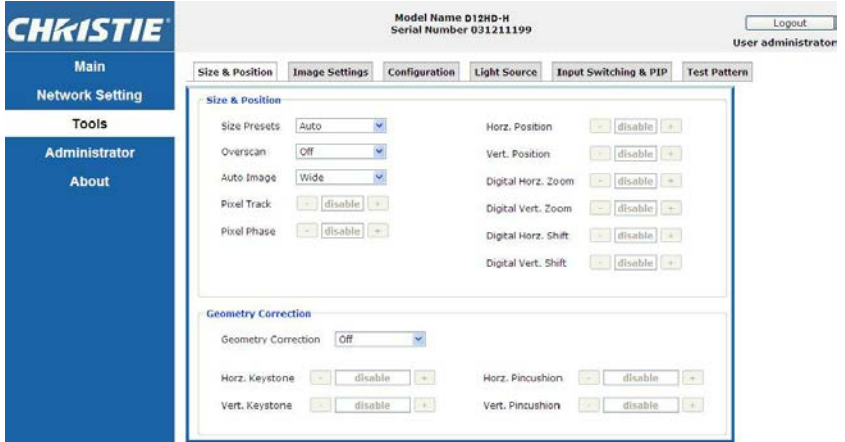

4.9.7 Administrator Page

Add or delete a user or change password.



4.9.8 About Page

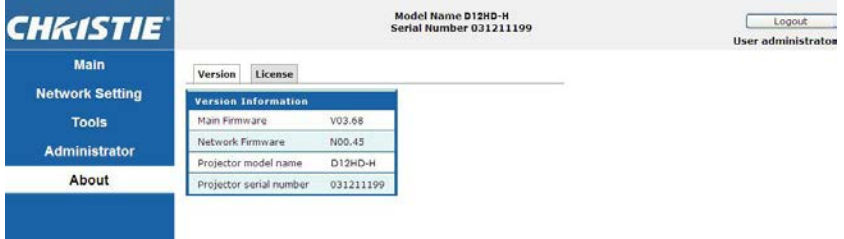

- **Version Tab**
View the main firmware version, network firmware version, projector model name, and projector serial number.
- **License Tab**
The license information of the computer program is displayed.

4.10 Christie Presenter

The Christie Presenter application allows a remote desktop from a host PC to be displayed on the network display through Ethernet, USB, or wireless transports. It can adapt to different network settings (DHCP, fixed IP, and direct link by USB/Ethernet cable).

Christie Presenter can be downloaded from the Christie website or from the web page of the projector.

4.10.1 Connect to the Projector

1. Connect to the projector using WiFi or Ethernet

- Ethernet connection:

- ▶ Determine the projector's IP address from the menu Main Menu > Configuration > Communications > LAN.

LAN	
1. DHCP	<input type="checkbox"/>
2. IP Address	192.168.0.100
3. Subnet Mask	255.255.255.0
4. Default Gateway	192.168.0.254
5. MAC Address	00:08:18:00:35:18

- ▶ Configure your PC IP address to be on the same network as the projector.
- ▶ The projector and computer must be connected directly or over the network using Ethernet.
- WiFi Wireless connection:
 - ▶ Insert the WiFi USB dongle (1DWUSB-BGN) into the USB port on the projector input panel.

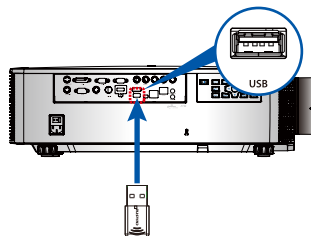

Insert the WiFi USB dongle

- ▶ Power on the Projector.
- ▶ Obtain the WiFi SSID from the OSD menu Main Menu > Configuration > Communications > WLAN.
- ▶ Connect your PC device to the wireless SSID for the selected projector . Example: "Christie@0111000123".



4.10.2 Install Christie Presenter software

1. Use a web browser to connect to the projector's network address (Default address 192.168.1.100).
2. Download and install the Christie Presenter Software.



3. Configure the Christie Presenter Software. The name entered is used to identify all computers connected to the projector by the Christie Presenter software/either wired or wireless connections. The Network Display Management -> Device Management tab shows all current connections.

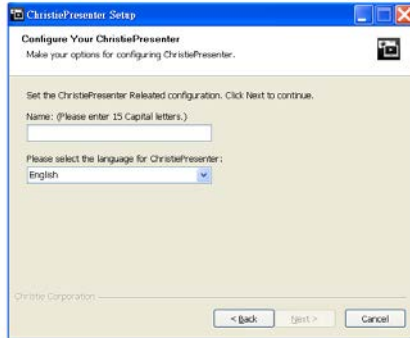







4.10.3 Use Christie Presenter

1. Press the autorun icon in the system tray to pause or play the USB display.



2. After starting the Christie Presenter application, the main window can be seen (shown below).



Icon	Description
	Connect and search network display.
	Stop/start displaying desktop contents to connected network display.
	Select display region.
	Configure Christie Presenter.
	Manage all connected network displays.
	Disconnect all connections.

Connect and search network display

- 1 Click the button  to enter into the connection menu section.

- 2 If the IP address of the projector is known, type the IP address and click the "Connect" button. If the IP address is not known, click the "Search" button to search for the projector on the network and select the projector to which you want to connect. Select the option "Directly" in order to proceed to the log in interface.

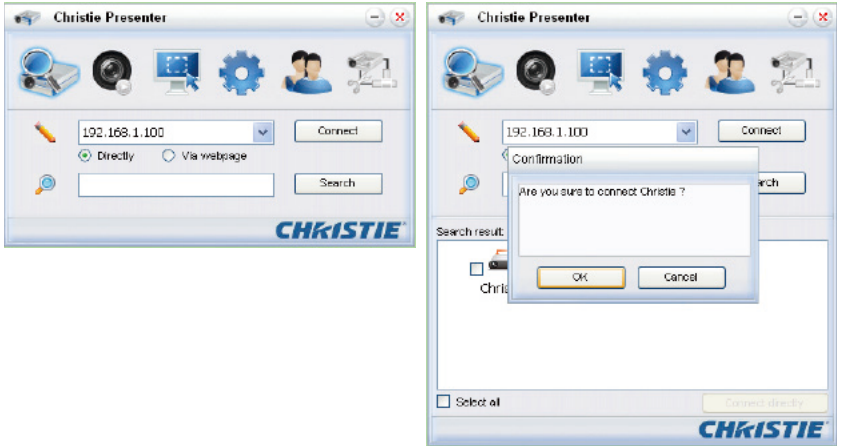

- 3 Input "User type" and "Password" in the log-in interface. Select the display port (the default is full screen). Obtain the "Normal" user's password from the OSD menu Main Menu > Configuration > Communications > WLAN.

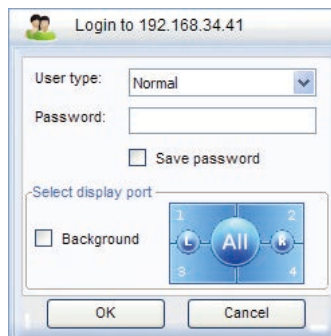

Select display region

Once the connection is set up, click the button  to select the size of the projection region: FullScreen, FixedSize, or Alterable.

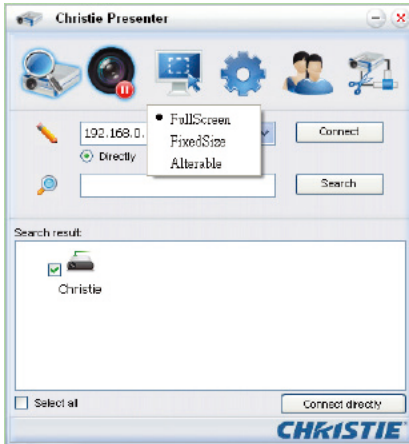

- **FullScreen:** The default capture mode turns to Full screen when the program is launched. At that time, if screen capture starts, the image of the whole screen is transferred to a remote network display.
- **FixedSize:** Users can place a frame on the desktop. Only the image enclosed inside the frame is transferred to remote network display.
- **Alterable:** Only region captured is the one enclosed by the frame. The region can be enlarged or downsized by dragging the eight small black squares scattered on eight edges of the frame.

Configure Christie Presenter

Click the button  to configure Christie Presenter for Basic Setting and Advanced Setting.

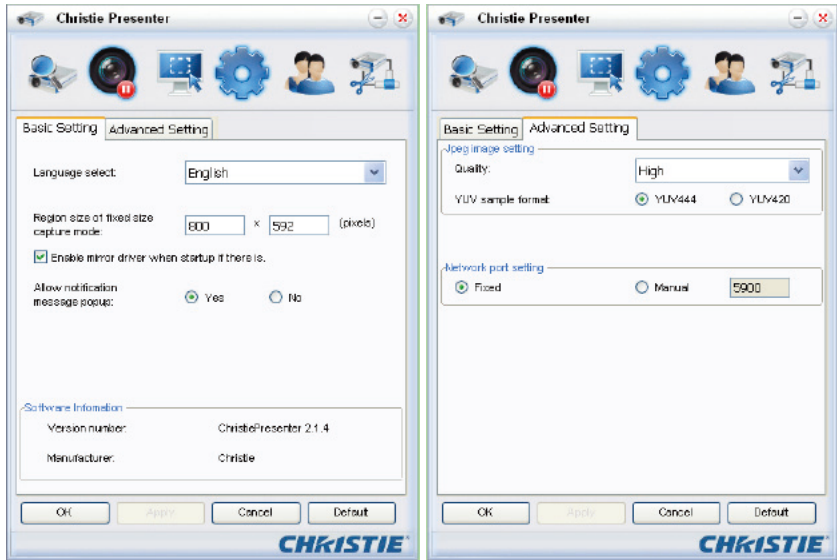







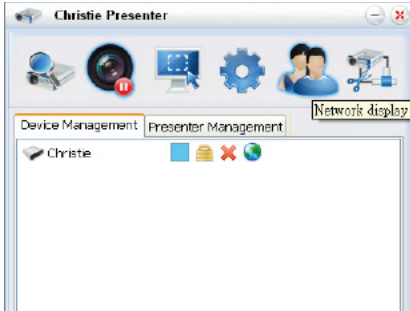

- Basic Setting: Select language, change the region size of fixed size capture mode, and select if notification message popup is allowed.
- Advanced Setting: Select the quality of JPEG image, YUV sample format and network port setting. (The "Fixed" port is Port 5900.)

Manage all connected network displays

Click the button  to control all the users and all the projectors connector to the same projector.



Icon	Description
	Administrator log in.
	Normal user log in.
	Device is connected.
	Device is not connected.
	The icon shows the current status and display position of the local screen on the network display. Click the icon to change the display position. A dialog appears.
	Click this unlock icon to change the password. (Password change to target network display. Only an Administrator user can change the password.)
	No response is expected when this icon is clicked. If user log in as "Admin", the key icon can be seen and the Presenter password can be changed. If user log in as "Normal", the lock icon can be seen and the Presenter password cannot be changed.
	Disconnect from target network display.
	Link for connecting to a target network display via a webpage.

4.11 Card Reader Operation

Four operation modes are available in the Card Reader application:

- USB Flash Devices Detection Screen
- Thumbnail Display Mode
- Images Display Mode
- Images Slide Show Mode

1. USB Flash Device Detection Screen:

In this mode, the Card Reader application detects any USB flash devices hot-plug events and displays the flash device icon. When the flash device is removed from USB, the icon disappears. We recommend that USB flash devices should be removed only when the Card Reader is changed to the USB Flash Devices Detection Screen state.

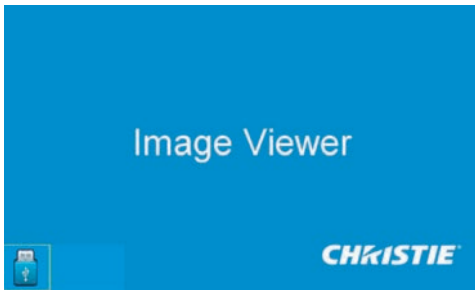

2. Thumbnail Display Mode:

Press the Enter key to enter the Thumbnail Display Mode. Different photos in different folders can be chosen. Press the Menu key to bring up the Card Reader operation UI.

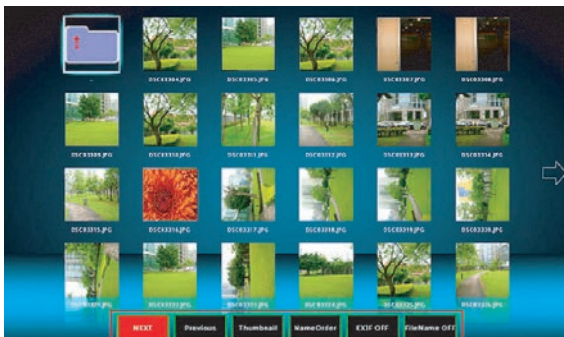

The user interface is designed to operate the card reader application with a few keys (Enter/Left/Right/Up/Down).

The following buttons are supported in the user interface:

- Previous: Move the selected item left. (Go to previous page when this is the leftmost item.)
- Next: Move the selected item right. (Go to next page when this is the rightmost item.)
- Display: Display the selected image or display the selected folder.
- Thumbnail: Enter the Thumbnail Display Mode.
- SlideShow: Enter the Slide Show Mode.
- NameOrder: Sort files/folders in name order.
- ExtendOrder: Sort files/folders in extended order.
- SizeOrder: Sort files/folders in size order.
- TimeOrder: Sort files/folders in time order.
- EXIF ON/OFF: Enable/Disable auto image rotate accordingly to EXIF information.
- FileName ON/OFF: Enable/Disable filename display in Thumbnail Display Mode.

3. Image Display Mode:

Press the ENTER key in the Thumbnail Display Mode to enter the Image Display Mode; press the SlideShow key to enter the Slide Show Mode. The Left/Right key is used to display the last/next image in the Image Display Mode. In the Image Display Mode, press the ENTER key to quit from the Image Display Mode and enter the Thumbnail Display Mode.

In the Slide Show Mode, press the ENTER key to enter the Image Display Mode.



The alternative way to display image in the Image Display Mode or Slide Show Mode is using the operation UI.

The following operations are supported in the operation UI.

- Display: Enter the Image Display Mode.
- Thumbnail: Enter the Thumbnail Display Mode.
- SlideShow: Enter the Slide Show Mode.
- Actual Size: Display in actual size of the image.
- Best Fit: Display the image in best fit to the screen.
- EXIFDisp OFF/On: Enable/Disable EXIF information display.
- +90deg: Rotate 90 degree.
- -90deg: Rotate -90 degree.



4. Image Slide Show Mode:

The following operations are supported in the Slide Show Mode operation UI.

- Stop: Stop Slide Show Mode.
- Next: Display next image.
- Previous: Display previous image.
- Delay 3/4/5: Slide Show delay in seconds.
- Slide Effect: Following modes are supported.
 - Slide Right
 - Blocks
 - RightDown
 - XLines
 - Slide Up
 - Ylines
 - Repeat ON/OFF: Enable/Disable Slide Show Repeat Mode.



When the image cannot be displayed due to memory limitation or cannot support image format, the specific image is displayed on the center of the screen.

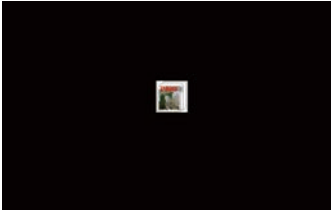

5. TROUBLESHOOTING

If you cannot resolve an issue using the information provided in this section, contact your reseller or service center.

Problem	Solution
<ul style="list-style-type: none"> - No image appears on-screen 	<ul style="list-style-type: none"> - Make sure all the cables and power connections are correctly and securely connected See "INSTALLATION". - Check if the Lamp Status LED is in Green. - Make sure you have removed the lens cap and the projector is switched ON.
<ul style="list-style-type: none"> • Partial, scrolling or incorrectly displayed image 	<ul style="list-style-type: none"> - Press "AUTO" on control panel or on remote control. - If using a PC (for Windows 95, 98, 2000, XP, Windows 7): <ol style="list-style-type: none"> 1. Click the "My Computer" > "Control Panel" and then double-click "Display". 2. Select the "Settings" tab. 3. Verify that your display resolution setting is lower than or equal to WUXGA (1920 × 1200). 4. Click on the "Advanced Properties" button. If the projector is still not projecting the whole image, change the monitor display: <ol style="list-style-type: none"> 4.1 Verify the resolution setting is lower than or equal to WUXGA (1920 × 1200). 4.2 Select the "Change" button under the "Monitor" tab. 4.3 Click on "Show all devices". Next, select "Standard monitor types" under the SP box; choose the resolution mode you need under the "Models" box. 4.4 Verify that the resolution setting of the monitor display is lower than or equal to WUXGA (1920 × 1200).

Problem	Solution																				
<ul style="list-style-type: none"> - Partial, scrolling or incorrectly displayed image 	<ul style="list-style-type: none"> - If using a Notebook: <ol style="list-style-type: none"> 1. Adjust resolution of the computer. 2. Press the keys listed below for your notebook manufacturer to send signal out from notebook to projector. Example: [Fn]+[F4] <table border="1" data-bbox="412 389 997 842" style="margin-left: 20px;"> <thead> <tr> <th>Notebook Brand</th> <th>Function Keys</th> </tr> </thead> <tbody> <tr> <td>Acer</td> <td>[Fn]+[F5]</td> </tr> <tr> <td>Asus</td> <td>[Fn]+[F8]</td> </tr> <tr> <td>Dell</td> <td>[Fn]+[F8]</td> </tr> <tr> <td>Gateway</td> <td>[Fn]+[F4]</td> </tr> <tr> <td>IBM/Lenovo</td> <td>[Fn]+[F7]</td> </tr> <tr> <td>HP/Compaq</td> <td>[Fn]+[F4]</td> </tr> <tr> <td>NEC</td> <td>[Fn]+[F3]</td> </tr> <tr> <td>Toshiba</td> <td>[Fn]+[F5]</td> </tr> <tr> <td>Mac Apple</td> <td>System Preference ⇒ Display ⇒ Arrangement ⇒ Mirror display</td> </tr> </tbody> </table> - If you experience difficulty changing resolutions or your monitor freezes, restart all equipment including the projector. 	Notebook Brand	Function Keys	Acer	[Fn]+[F5]	Asus	[Fn]+[F8]	Dell	[Fn]+[F8]	Gateway	[Fn]+[F4]	IBM/Lenovo	[Fn]+[F7]	HP/Compaq	[Fn]+[F4]	NEC	[Fn]+[F3]	Toshiba	[Fn]+[F5]	Mac Apple	System Preference ⇒ Display ⇒ Arrangement ⇒ Mirror display
Notebook Brand	Function Keys																				
Acer	[Fn]+[F5]																				
Asus	[Fn]+[F8]																				
Dell	[Fn]+[F8]																				
Gateway	[Fn]+[F4]																				
IBM/Lenovo	[Fn]+[F7]																				
HP/Compaq	[Fn]+[F4]																				
NEC	[Fn]+[F3]																				
Toshiba	[Fn]+[F5]																				
Mac Apple	System Preference ⇒ Display ⇒ Arrangement ⇒ Mirror display																				
<ul style="list-style-type: none"> • The screen of the Notebook or PowerBook computer is not displaying your presentation 	<ul style="list-style-type: none"> - If using a Notebook PC Some Notebook PCs may deactivate their own screens when a second display device is in use. Each has a different method of reactivation. Refer to your computer manual for detailed information. 																				
<ul style="list-style-type: none"> • Image is unstable or flickering 	<ul style="list-style-type: none"> - Use "Pixel Track" and "Pixel Phase" to correct it. - Change the monitor color setting on your computer. 																				
<ul style="list-style-type: none"> • Image has vertical flickering bar 	<ul style="list-style-type: none"> - Use "Auto Image" to make an adjustment. - Check and reconfigure the display mode of your graphic card to make it compatible with the projector. 																				

Problem	Solution
<ul style="list-style-type: none">• Image is out of focus	<ul style="list-style-type: none">- Make sure both lens caps (front and back) are removed.- Adjust lens focus to fit.- Make sure the projection screen is between the required distance.
<ul style="list-style-type: none">• The image is stretched when displaying 16:9 DVD title	<ul style="list-style-type: none">- When you play anamorphic DVD or 16:9 DVD, the projector shows the best image if the projector display mode is set to 16:9 in the OSD.- If you play 4:3 format DVD titles, change the format to 4:3 in the projector OSD.- If the image is still stretched, you must also adjust the aspect ratio by setting the display format as 16:9 (wide) aspect ratio type on your DVD player.
<ul style="list-style-type: none">• Image is too small or too large	<ul style="list-style-type: none">- Adjust lens zoom to fit.- If the image does not fill the screen properly, verify that the correct lens is in use or change the position of the projector.

6. SPECIFICATIONS

6.1 Inputs

Signal Type	Resolution	Frame Rate (Hz)	VGA	BNC	HDMI ½	DVI	Display port	3G-SDI	HDBaseT	CVBS
PC	640x350	85			•	•	•		•	
	640x400	85	•	•	•	•	•		•	
	640x480	59			•	•	•		•	
	640x480	60	•	•	•	•	•		•	
	640x480	72	•	•	•	•	•		•	
	640x480	75	•	•	•	•	•		•	
	640x480	85	•	•	•	•	•		•	
	720x400	60	•	•	•	•	•		•	
	720x400	85	•	•						
	768x480	60			•	•	•		•	
	768x480	75			•	•	•		•	
	768x480	85			•	•	•		•	
	800x600	50			•	•	•		•	
	800x600	56	•	•	•	•	•		•	
	800x600	60	•	•	•	•	•		•	
	800x600	72	•	•	•	•	•		•	
	800x600	75	•	•	•	•	•		•	
	800x600	85	•	•	•	•	•		•	
	800x600	120			•	•			•	
	848x480	50			•	•	•		•	
	848x480	60			•	•	•		•	
	848x480	75			•	•	•		•	
	848x480	85			•	•	•		•	
	960x600	50			•	•	•		•	
960x600	60			•	•	•		•		
960x600	75			•	•	•		•	•	

NOTE:

❖ "RB" means "reduced blanking".

Signal Type	Resolution	Frame Rate (Hz)	VGA	BNC	HDMI %	DVI	Display port	3G-SDI	HDBaseT	CVBS
PC	960x600	85			•	•	•		•	•
	1024x768	60	•	•	•	•	•		•	
	1024x768	75	•	•	•	•	•		•	
	1024x768	85	•	•	•	•	•		•	
	1024x768	120	•		•	•			•	
	1064x600	50			•	•	•		•	
	1064x600	60			•	•	•		•	
	1064x600	75			•	•	•		•	
	1064x600	85			•	•	•		•	
	1152x720	50			•	•	•		•	
	1152x720	60			•	•	•		•	
	1152x720	75			•	•	•		•	
	1152x720	85			•	•	•		•	
	1152x864	60	•	•	•	•	•		•	
	1152x864	70	•	•	•	•	•		•	
	1152x864	75	•	•	•	•	•		•	
	1152x864	85	•	•	•	•	•		•	
	1224x768	50			•	•	•		•	
	1224x768	60			•	•	•		•	
	1224x768	85			•	•	•		•	
	1280x720	50			•	•	•		•	
	1280x720	60	•	•	•	•	•		•	
	1280x720	75	•	•	•	•	•		•	
	1280x720	85	•	•	•	•	•		•	
	1280x720	120	•		•	•			•	
	1280x768	60	•	•	•	•	•		•	
	1280x768	75	•	•	•	•	•		•	

Signal Type	Resolution	Frame Rate (Hz)	VGA	BNC	HDMI ½	DVI	Display port	3G-SDI	HDBaseT	CVBS
PC	1280x768	85	•	•	•	•	•		•	
	1280x800	50	•	•	•	•	•		•	
	1280x800	60	•	•	•	•	•		•	
	1280x800	75	•	•	•	•	•		•	
	1280x800	85	•	•	•	•	•		•	
	1280x960	50			•	•	•		•	
	1280x960	60	•	•	•	•	•		•	
	1280x960	75	•	•	•	•	•		•	
	1280x960	85	•	•	•	•	•		•	
	1280x1024	50			•	•	•		•	
	1280x1024	60	•	•	•	•	•		•	
	1280x1024	75	•	•	•	•	•		•	
	1280x1024	85	•	•	•	•	•		•	
	1356x960	50				•				
	1356x960	60				•				
	1356x960	75				•				
	1356x960	85				•				
	1360x768	50			•	•	•		•	
	1360x768	60			•	•	•		•	
	1360x768	75			•	•	•		•	
	1360x768	85			•	•	•		•	
	1366x768	60	•	•	•	•	•		•	
	1400x900	60	•	•		•				
	1400x1050	50			•	•	•		•	
	1400x1050	60	•	•	•	•	•		•	
	1400x1050	75	•	•	•	•	•		•	
	1440x900	60	•	•	•	•	•		•	
	1440x900	75			•	•	•		•	

Signal Type	Resolution	Frame Rate (Hz)	VGA	BNC	HDMI ½	DVI	Display port	3G-SDI	HDBaseT	CVBS
PC	1600x900	60			•	•	•		•	
	1600x1200	50			•	•	•		•	
	1600x1200	60	•	•	•	•	•		•	
	1680x1050	50			•	•	•		•	
	1680x1050	60	•	•	•	•	•		•	
	1680x1050	75				•				
	1704x960	50			•	•	•		•	
	1704x960	60			•	•	•		•	
	1704x960	75				•				
	1704x960	85				•				
	1728x1080	50			•	•	•		•	
	1728x1080	60			•	•	•		•	
	1864x1050	50			•	•	•		•	
	1864x1050	60			•	•	•		•	
	1864x1050	75				•				
	1920X1080	50			•	•	•		•	
	1920X1080	60	•	•	•	•	•		•	
	1920X1200RB	60	•	•	•	•	•		•	
	1920X1200RB	50	•	•	•	•	•		•	
	2128x1200	60				•				
NTSC	NTSC (M, 4.43)	60								•
PAL	PAL (B,G,H,I)	50								•
	PAL (N)	50								•
	PAL (M)	60								•
SECAM	SECAM (M)	50								•
	480i	60	•	•	•	•	•		•	
	576i	50	•	•	•	•	•		•	

Signal Type	Resolution	Frame Rate (Hz)	VGA	BNC	HDMI ½	DVI	Display port	3G-SDI	HDBaseT	CVBS
EDTV	480p	60	•	•	•	•	•		•	
	576p	50	•	•	•	•	•		•	
HDTV	1080i	25	•	•	•	•			•	
	1080i	29	•	•	•	•	•		•	
	1080i	30	•	•	•	•	•		•	
	720p	50	•	•	•	•	•		•	
	720p	59	•	•	•	•	•		•	
	720p	60	•	•	•	•	•		•	
	1080s	23				•				
	1080s	24				•				
	1080p	23	•	•	•	•	•		•	
	1080p	24	•	•	•	•	•		•	
	1080p	25	•	•	•	•	•		•	
	1080p	29	•	•	•	•	•		•	
	1080p	30	•	•	•	•	•		•	
	1080p	50	•	•	•	•	•		•	
	1080p	59	•	•	•	•	•		•	
	1080p	60	•	•	•	•	•		•	
Mandatory 3D	Frame Packing 1080p	24			•				•	
	Frame Packing 720p	50			•				•	
	Frame Packing 720p	60			•				•	
	Side by Side 1080i	50			•				•	
	Side by Side 1080i	60			•				•	
	Top and Bottom 720p	50			•				•	
	Top and Bottom 720p	60			•				•	
Top and Bottom 1080p	24			•				•		

Signal Type	Resolution	Frame Rate (Hz)	VGA	BNC	HDMI ½	DVI	Display port	3G-SDI	HDBaseT	CVBS	
Frame sequential 3D	800x600	120			•				•		
	1024x768	120			•				•		
	1280x720	120			•				•		
SD-SDI	480i YcbCr422 10bit	59.94						•			
	576i YcbCr422 10bit	50						•			
HD-SDI	720p YcbCr422 10bit	50						•			
		59.94						•			
		60							•		
	1080i YcbCr422 10bit	50							•		
		59.94							•		
		60							•		
	1080p YcbCr422 10bit	23.98							•		
		24							•		
		25							•		
		29.97							•		
		30							•		
		25							•		
1080sF YcbCr422 10bit	29.97							•			
	30							•			
3GA-SDI	1080p YcbCr422 10bit	50						•			
		59.94						•			
		60							•		
3GB-SDI	1080p YcbCr422 10bit With 352M Payload ID	50						•			
		59.94						•			
		60							•		

6.2 PIP/POP Compatibility

PIP/POP Matrix	3G-SDI	VGA	BNC	DVI	CVBS	Display Port	HDMI1	HDMI2	HDBaseT RJ45-1	USB A	Mini USB	RJ45-2
3G-SDI	-	-	-	-	•	•	•	•	•	•	•	•
VGA	-	-	-	-	•	•	•	•	•	•	•	•
BNC	-	-	-	-	•	•	•	•	•	•	•	•
DVI	-	-	-	-	•	•	•	•	•	•	•	•
CVBS	•	•	•	•	-	-	-	-	-	-	-	-
Display Port	•	•	•	•	-	-	-	-	-	-	-	-
HDMI1	•	•	•	•	-	-	-	-	-	-	-	-
HDMI2	•	•	•	•	-	-	-	-	-	-	-	-
HDBaseT RJ45-1	•	•	•	•	-	-	-	-	-	-	-	-
USB A	•	•	•	•	-	-	-	-	-	-	-	-
Mini USB	•	•	•	•	-	-	-	-	-	-	-	-
RJ45-2	•	•	•	•	-	-	-	-	-	-	-	-

• : PIP/POP combinations are enabled
 - : PIP/POP combinations are disabled

6.3 Key Features

- HD 0.95" 1920 × 1080 resolution or WUXGA 0.96" 1920 × 1200 resolution
- Projection lens compatibility:
 - Horizontal offset ranges: +/-50%
 - Vertical offset ranges: +/-120% (WUXGA) and +/-140% (HD)

NOTE:

❖ *Measurements are based on industry standards where offset is calculated as a ratio of the number of pixels shifted up/ down to half the image size.*

- 360 degree orientation
- Optional color wheel for rich color performance
- 3D blending & auto warping for different application
- Support dust / fog filter to make projector get a better life time.

NOTE:

❖ *Dust filter will be standard accessory.
Fog filter will be optional parts.*

- Wireless desktop display using wireless dongle (optional)
- SNMP traps and email notifications
- 10-bit image processor electronics with modular design
- All video formats can be resized to full screen either horizontally or vertically while maintaining aspect ratio
- The projector can be operated using any of the following:
 - The built-in keypad, an infrared (IR) remote control, a wired remote control, a PC/device using serial communications (Ethernet or RS232)
 - A Web page via Ethernet or from a PC/device via a wireless USB dongle (Optional)
- Built-In keypad

6.4 List of Components

This projector comes with all the items listed below. Check to make sure your package is complete. Contact your dealer if anything is missing.

- IR remote control 003-004468-01
- Power cord x 4
 - UK/Korea/Russia
 - North America
 - Europe
 - Japan
- User manual (CD)
- Fuse (15A fuse installed in the projector)
- Dust Filter x 3 (It will be applied in the environment which got serious dust.)

NOTE:

- ❖ *Due to the difference in applications for each country, some regions may have different accessories.*

6.5 Optional Accessories

- Standard Lens (A21-TR 1.5-2.0) (140-110103-01)
- Optional Lens (A20-TR 1.2-1.5) (140-109101-01)
- Optional Lens (A22-TR 2.0-4.0) (140-111104-01)
- Optional Lens (A18-TR 0.84-1.02) (140-114107-01)
- Optional Lens (A19-TR 1.02-1.36) (140-115108-01)
- 1DWUSB-BGN / Wireless dongle (optional accessory) (133-113106-01)
- Lens adapter (140-112105-01)
- Optional Color Wheel

6.6 REGULATORY

- Safety
 - CSA C22.2 No. 60950-1
 - UL 60950-1
 - IEC 60950-1
 - EN 60950-1
- Electro-Magnetic Compatibility

Emissions

- FCC CFR47, Part 15, Subpart B/ANSI C63.4, Class A - Unintentional Radiators
- CISPR 22/EN55022 Class A - Information Technology Equipment
- ICES/NMB003 (A) - Information Technology Equipment

Immunity

- CISPR 24/EN55024 EMC Requirements - Information Technology Equipment
- Environmental
- The product conforms to:
 - EU Directive (2011/65/EU) on the restriction of the use of certain hazardous substances (RoHS) in electrical and electronic equipment and the applicable official amendment(s).
 - EU Regulation (EC) No. 1907/2006 on the registration, evaluation, authorization and restriction of chemicals (REACH) and the applicable official amendment(s).
 - EU Directive (2012/19/EU) on waste and electrical and electronic equipment (WEEE) and the applicable official amendment(s).
 - China Ministry of Information Industry Order No.39 (02/2006) on the control of pollution caused by electronic information products, the

hazardous substances concentration limits (SJ/T11363-2006), and the applicable product marking requirement (SJ/T11364-2006).

- Marking
 - This product conforms to all relevant Canadian, US, and European directives, standards, safety, health and environmental concerns. International packaging recycling marks conform to:
 - ▶ EU Directive (2012/19/EU) on waste and electrical and electronic equipment (WEEE) .
 - ▶ EU Directive (94/62/EC) on packaging and packaging waste
 - ▶ China packaging recycling mark standard (GB18455-2001)

6.7 Federal Communications Commission (FCC) Warning

⚠ WARNING

- A shielded-type power cord is required to meet FCC emission limits and also to prevent interference to the nearby radio and television reception. Only the supplied power cord must be used.
- Use only shielded signal cables to connect I/O devices to this equipment.

6.8 OSD Tree

Level 1	Level 2	Level 3(Or List)	Level 4(Or List)	Level 5(Or List)	Level 6(Or List)	Default	
Size & Position	Size Presets	Auto				Auto	
		Native					
		4:3					
		Letterbox					
		Full Size					
		Full Width					
		Full Height					
		Custom					
	Overscan	3D Mode					
		Off				By source set	
		Zoom					
	Crop						
	Pixel Track	0 - 100				50	
	Pixel Phase	0 - 100				50	
	Horz Position	0 - 100				50	
	Vert Position	0 - 100				50	
	Digital Horz Zoom	50%~400%				100	
	Digital Vert Zoom	50%~400%				100	
	Digital Horz Shift	0 - 100				50	
	Digital Vert Shift	0 - 100				50	
Geometry Correction	Warp	PC Mode				On	
		Keystone	Horz Keystone	-20 ~ +20		0	
			Vert Keystone	-20 ~ +20		0	
		Pincushion	Horz Pincushion	-50 ~ +50			0
			Vert Pincushion	-50 ~ +50			0
Reset	command						
Auto Image	command						
Image settings	Brightness	0 - 100				50	
	Contrast	0 - 100				By source set	
		Auto					
	Color Space	RGB	RGB				RGB
			RGB Video				
			REC709				
		YUV	REC709				REC709
			REC601				
	Detail	Maximum					By source set
		High					
		Normal					
		Low					
		Minimum					
	3D Display	3D Enable	Auto				Auto
			Frame Packing-Side by Side				
Top and Bottom							
Feame Sequential							
Off							
3D Invert		Off/On				Off	
Toggle 3D Blending	command						

Level 1	Level 2	Level 3(Or List)	Level 4(Or List)	Level 5(Or List)	Level 6(Or List)	Default
Image settings	Video Options	Color	0 - 100			50
		Tint	0 - 100			50
		Noise Reduction	0 - 100			0
		Flesh Tone Cor- rection	0 - 100			0
		Video Black Level				
		Detect Film	Off/On			Off
		Closed captions	Off			
	cc1				Off	
	Input Levels	cc2				
		Red Gain	0 - 100			50
		Green Gain	0 - 100			50
		Blue Gain	0 - 100			50
		Red Offset	0 - 100			50
		Green Offset	0 - 100			50
		Blue Offset	0 - 100			50
	Sync Threshold	0 - 100			50	
	Reset RGB Gain/ Offset	command				
	Picture Settings	Presentation				By source set
		Video				
		Bright				
		Real				
		DICOM SIM				
		2D High Speed				
		3D				
	User					
	Save to User	command				
	DynamicBlack™	Off / On			Off	
	Image Freeze	Off / On			Off	
	Advanced Image Settings	Gamma	Video	Off		By source set
				On		
				Off		
				On		
				Off		
BrilliantColor™		Film	Normal Look		Bright Look	
			Bright Look			
White Peaking		0 - 100			By source set	
Color Tempera- ture		Warmest	Warmest		By source set	
			Warm			
			Cool			
			Bright			
Edge Enhance- ment		Off	Off		Off	
			Normal			
Color Wheel Speed	Maximum	Off		2X		
		2X				
		3X				
Color Enhance- ment	Off	Off		CE 1		
		CE 1				
		CE 2				

Level 1	Level 2	Level 3(Or List)	Level 4(Or List)	Level 5(Or List)	Level 6(Or List)	Default		
Configuration	Language					English		
	Lens Settings	Focus	command					
		Zoom	command					
		Lens Shift	command					
		Lens Memory	Apply Position	1 - 5				
			Save Current Position	1 - 5				
		Lock all Lens Motors	Allow Locked				Allow	
	Lens calibration	command						
	Ceiling Mount	Off/On/Auto					Auto	
	Rear Projection	Off/On					Off	
	Menu Preferences	Menu Horz Offset	0 - 100				0	
		Menu Vert Offset	0 - 100				0	
		Show Messages	Off/On					
		Menu Transparency	0 - 90				0	
		Splash Screen Setup	Factory Logo					Factory Logo
			Blue					
			Black					
			White					
		PIN Protect	command					
	Change PIN	command						
	Power Management	Standby Mode	0.5 W Mode				Communication mode	
			Communication mode					
		AC Power On	Off/On				Off	
		Auto Shutdown	Never				Never	
			5 Mins					
			10 Mins					
			15 Mins					
			20 Mins					
			25 Mins					
		30 Mins						
	Sleep Timer	Off				Off		
		2 Hrs						
		4 Hrs						
	6 Hrs							
	High Altitude	Off/On				Off		
	Communications	LAN	DHCP				by set	
			IP Address					
			Subnet Mask					
			Default Gateway					
			MAC Address					
		WLAN	Enable				by set	
			Start IP					
			End IP					
			Subnet Mask					
			Default Gateway					
MAC Address								
SSID								
Network		Projector Name				by set		
		Show Network Messages						
		Restart Network...						
		Network Factory Reset...						

Level 1	Level 2	Level 3(Or List)	Level 4(Or List)	Level 5(Or List)	Level 6(Or List)	Default
Configuration	Communications	Serial Port Baud Rate	2400			115200
			4800			
			9600			
			14400			
			19200			
			38400			
			57600			
			115200			
		1200				
		Serial Port Echo	Off/On			Off
	Serial Port Path	RS232			RS232	
		HDBaseT				
	Projector Address	0 - 9			0	
	Backlight Preferences	Keypad Backlight	Timeout 5 Secs			Timeout 5 Secs
			Timeout 10 Secs			
			Timeout 20 Secs			
			Timeout 30 Secs			
			Always On			
		Always Off				
		Status LED	Always On			Always On
			Always Off			
			Warnings/Errors Only			
		Color Matching	Meter Adjustment	Enable	On/Off	
	Auto Test Pattern			On/Off		On
	Measured Data			Intensity of Red	100 - 10000	453
				x of Red	0.300 - 0.700	0.633
				y of Red	0.300 - 0.500	0.356
				Intensity of Green	100 - 10000	2137
				x of Green	0.300 - 0.400	0.352
				y of Green	0.400 - 0.700	0.572
				Intensity of Blue	100 - 10000	239
				x of Blue	0.100 - 0.300	0.140
				y of Blue	0.030 - 0.400	0.093
				Intensity of White	100 - 10000	9219
				x of White	0.200 - 0.400	0.331
				y of White	0.200 - 0.400	0.380
	Reset to Default			Yes/No		
	Target Data		Gain of Red	0.200 - 1.000	1.000	
			x of Red	0.300 - 0.700	0.643	
			y of Red	0.300 - 0.500	0.344	
			Gain of Green	0.200 - 1.000	1.000	
			x of Green	0.300 - 0.400	0.329	
y of Green			0.400 - 0.700	0.544		
Gain of Blue			0.200 - 1.000	1.000		
x of Blue			0.100 - 0.300	0.141		
y of Blue			0.030 - 0.400	0.094		
Gain of White			0.200 - 1.000	1.000		
x of White			0.200 - 0.400	0.334		
y of White			0.200 - 0.400	0.371		
Reset to Default			Yes/No			
Enable			On/Off		Off	
Auto Test Pattern			On/Off		On	
Red Part of Red	0 - 1000	1000				
Green Part of Red	0 - 1000	0				
Blue Part of Red	0 - 1000	0				

Section 6: SPECIFICATIONS



Level 1	Level 2	Level 3(Or List)	Level 4(Or List)	Level 5(Or List)	Level 6(Or List)	Default	
Configuration	Color Matching	Manual Adjust- ment	Green Part of Green	0 - 1000		1000	
			Red Part of Green	0 - 1000		0	
			Blue Part of Green	0 - 1000		0	
			Blue Part of Blue	0 - 1000		1000	
			Red Part of Blue	0 - 1000		0	
			Green Part of Blue	0 - 1000		0	
			Red Part of White	0 - 1000		1000	
			Green Part of White	0 - 1000		1000	
			Blue Part of White	0 - 1000		1000	
			Reset to Default	Yes/No			
		Hot-Key Settings	Blank Screen				
			Aspect Ratio				
			Freeze Screen				
			Projector Info				
			Overscan				
			Closed Captions				
		Service	Projector Info	Model Name			
				Serial Number			
				Native Resolution			
				Firmware			
				Configuration			
				Boot Code			
				Standby Mode			
				Lens Lock Settings			
				Color wheel Index			
			Factory Reset...	command			
				Off			
				Grid			
				White			
				Black			
				Checkerboard			
				Color Bars			
				Red			
				Green			
				Blue			
				Yellow			
				Magenta			
				Cyan			
				Boresight			
				Color wheel Index (2x)			
				Color wheel Index (3x)			
				Error log	Show log		
			Clear log				
		Mode Adjustment					
		DA mode	DA Offset				
			DA Calibration				
			DA Check				
			Always Calibration				

Level 1	Level 2	Level 3(Or List)	Level 4(Or List)	Level 5(Or List)	Level 6(Or List)	Default	
Lamp	Lamp Mode	Constant Power/ Constant Intensity/ ECO mode				Constant Power	
	Constant Power	0 - 10				10	
	Constant Intensity	0 - 10				7	
	Current Lamp	Lamp 1					Both
		Lamp 2					
		Both					
	Lamp Auto Switch	On Failure Only					On Failure Only
		At Power-Up					
		After X Hours					
	Lamp Auto Switch Time (Hours)	5 - 3000					100
	Lamp Info	Lamp 1 Hours					
		Lamp 2 Hours					
		Total Projector Hours					
		Lamp 1 Reset					
		Lamp 2 Reset					
Lamp Life Setting	xxxxx					2000 hrs	
Reset Lamp Hours	command						
Light Sensor	Light Sensor Calibration		command				
	Calibrated?		(display Yes/No)				
Status	Model Name						
	Serial Number						
	Native Resolution						
	Firmware					Vxx, Ayy, Bzz	
	Main Input						
	Main Signal Format						
	Main Pixel Clock						
	Main Sync Type						
	Main Horz Refresh						
	Main Vert Refresh						
	PIP/PBP Input						
	PIP/PBP Signal Format						
	PIP/PBP Pixel Clock						
	PIP/PBP Sync Type						
	PIP/PBP Horz Refresh						
	PIP/PBP Vert Refresh						
	Lamp Power Settings						
	Current Lamp						
	Lamp 1 Hours						
	Lamp 2 Hours						
	Standby Mode						
	Lens Lock Settings						
	IP Address						
DHCP							
System Temperature							

Level 1	Level 2	Level 3(Or List)	Level 4(Or List)	Level 5(Or List)	Level 6(Or List)	Default	
Input Switching & PIP	Main Input	SPEC define					
	PIP/PBP Input	SPEC define					
	PIP/PBP Enable	OFF					OFF
		ON					
	Swap						
	Size	(Small/Medium/Large)					
	Main Layout	(PBP, Main Left / PBP, Main Top / PBP, Main Right / PBP, Main Bottom / PIP-Bottom Right / PIP-Bottom Left / PIP-Top Left / PIP-Top Right)					
	Timing Detection Mode	Normal					Wide
		Wide					
	Source Info	Active Source					
		Signal Format					
		Aspect Ratio					
		Resolution					
		Vert Refresh					
		Horz Refresh					
		Pixel Clock					
		Sync Type					
		Color Space					
			PIP/PBP	(When PIP/PBP active)			
		<PIP/PBP source lines>	(When PIP/PBP active)				
Input key	Change Sources					Auto Source	
	List all Sources						
	Auto Source						
Blank on Signal Switch	OFF					OFF	
	ON						
Language						English	
Test Pattern	Off						
	Grid						
	White						
	Black						
	Checkerboard						
	Color Bars						

Corporate offices

USA – Cypress
ph: 714-236-8610

Canada – Kitchener
ph: 519-744-8005

Consultant offices

Italy
ph: +39 (0) 2 9902 1161

Worldwide offices

Australia
ph: +61 (0) 7 3624 4888

Brazil
ph: +55 (11) 2548 4753

China (Beijing)
ph: +86 10 6561 0240

China (Shanghai)
ph: +86 21 6278 7708

Eastern Europe and
Russian Federation
ph: +36 (0) 1 47 48 100

France
ph: +33 (0) 1 41 21 44 04

Germany
ph: +49 2161 664540

India
ph: +91 (080) 6708 9999

Japan
ph: 81-3-3599-7481

Korea (Seoul)
ph: +82 2 702 1601

Republic of South Africa
ph: +27 (0)11 510 0094

Singapore
ph: +65 6877-8737

Spain
ph: + 34 91 633 9990

United Arab Emirates
ph: +971 4 3206688

United Kingdom
ph: +44 118 977 8000

This file was downloaded from the site
mans.io

Instruction manuals and user guides

[Samsung](#)

[Pioneer](#)

[Alpine](#)

[LG](#)

[Dell](#)

[Sharp](#)

[Sony](#)

[Philips](#)

[Epson](#)

[Netgear](#)